

V1.5 2026-04-10

Residential Smart Inverter

ET LV 5.0-20kW

LX A5.0-30

GW14.3-BAT-LV-G10

LX U5.0-30

GW16.1-BAT-LV-G10

Solutions Manual

GOODWE

Copyright Statement

Copyright Statement

Copyright©GoodWe Technologies Co., Ltd. 2026. All rights reserved.

Without the authorization of GoodWe Technologies Co., Ltd., no part of this manual may be reproduced, disseminated, or uploaded to third-party platforms such as public networks in any form.

Trademark Authorization

GOODWE and other GOODWE trademarks used in this manual are owned by GoodWe Technologies Co., Ltd. All other trademarks or registered trademarks mentioned in this manual belong to their respective owners.

NOTICE

Due to product version upgrades or other reasons, the content of this document is updated periodically. Unless otherwise agreed, the content of this document cannot replace the safety precautions on the product label. All descriptions in this document are for guidance only.

About This Manual

Overview

This document primarily introduces the product information, installation wiring, configuration tuning, troubleshooting, and maintenance content of the energy storage system composed of inverters, battery systems, and smart meters. Please read this manual carefully before installing and using the product to understand product safety information and familiarize yourself with the product's functions and features. The document may be updated periodically; please obtain the latest version and more product information from the official website.



Applicable Model

The energy storage system includes the following products:

Product Type	Product Information	Description
Inverter	GW5K-ET-L-G10	Nominal output power: 5.0kW
	GW6K-ET-L-G10	Nominal output power: 6.0kW
	GW8K-ET-L-G10	Nominal output power: 8.0kW
	GW10K-ET-L-G10	Nominal output power: 10kW
	GW12K-ET-L-G10	Nominal output power: 12kW
	GW15K-ET-L-G10	Nominal output power: 15kW
	GW20K-ET-L-G10	Nominal output power: 20kW
	GW12K-ET-LL-G10	Nominal output power: 12kW
	LX A5.0-30	Rated energy 5.12kWh, supports up to 30 clusters in parallel
	GW14.3-BAT-LV-G10	Rated energy 14.3kWh, supports up to 30 clusters in parallel

Product Type	Product Information	Description
Battery system	LX U5.0-30	Rated energy 5.12kWh, supports up to 30 clusters in parallel
	GW16.1-BAT-LV-G10	Rated capacity 16.1kWh, supports up to 30 clusters in parallel
Smart Meter	GM330	Monitoring module in the energy storage system, capable of detecting operating voltage, current, and other information within the system.
Smart dongle	WiFi/LAN Kit-20	Can upload system operating information to the monitoring platform via WiFi or LAN signals.
	4G Kit-G20	Can upload system operating information to the monitoring platform via 4G.
	4G Kit-CN-G20 (China only)	Can upload system operating information to the monitoring platform via 4G.

Symbol Definition

 DANGER
Indicates a highly potential hazard which, if not avoided, will result in death or serious injury.
 WARNING
Indicates a moderately potential hazard which, if not avoided, could result in death or serious injury.
 CAUTION
Indicates a low-level potential hazard which, if not avoided, may result in moderate or minor injury.

NOTICE

Emphasizes and supplements the content, may also provide tips or tricks for optimal product use, which can help you solve a problem or save your time.

Table of Contents

1 Safety Precautions	15
1.1 General Safety	15
1.2 personnel requirements	15
1.3 System Safety	16
1.3.1 PV String Safety	18
1.3.2 Inverter Safety	19
1.3.3 Battery Safety	20
1.3.4 Smart Meter Safety	22
1.4 Safety Symbols and Certification Marks	23
1.5 EU Declaration of Conformity	25
1.5.1 Equipment with Wireless Communication Modules	25
1.5.2 No Equipment with Wireless Communication Modules (except Battery)	25
1.5.3 Battery	26
2 System Introduction	27
2.1 System Overview	27
2.2 Product Overview	50
2.2.1 Inverter	50
2.2.2 Battery	54
2.2.2.1 LX A5.0-30	55
2.2.2.2 GW14.3-BAT-LV-G10	56
2.2.2.3 LX U5.0-30	57

2.2.2.4 GW16.1-BAT-LV-G10	58
2.2.3 Smart Meter	59
2.2.4 smart dongle	61
2.3 Supported Grid Types	62
2.4 System Working Mode	62
2.5 Features	73
3 Check and Storage	78
3.1 Check Before Receiving	78
3.2 deliverables	78
3.2.1 Inverter Deliverables	78
3.2.2 Batteries Deliverables	81
3.2.2.1 Batteries Deliverables(LX A5.0-30)	81
3.2.2.2 Batteries Deliverables(GW14.3-BAT-LV-G10)	83
3.2.2.3 Batteries Deliverables(GW16.1-BAT-LV-G10)	84
3.2.2.4 Batteries Deliverables(LX U5.0-30)	85
3.2.3 Combiner Box	86
3.2.3.1 BCB-22-WW-0	86
3.2.3.2 BCB-32-WW-0	87
3.2.4 Smart Meter Deliverables(GM330)	87
3.2.5 smart dongledeliverables	88
3.2.5.1 Attachment List	88
3.3 Storage	88

4 Installation	91
4.1 System Installation and Commissioning Procedure	91
4.2 Installation Requirements	91
4.2.1 Installation Environment Requirements	92
4.2.2 Installation Space Requirements	94
4.2.3 Tool Requirements	96
4.3 Equipment Handling	98
4.4 Installing the Inverter	100
4.5 Installing the Battery System	101
4.5.1 LX A5.0-30	102
4.5.2 GW14.3-BAT-LV-G10	104
4.5.3 LX U5.0-30	105
4.5.4 GW16.1-BAT-LV-G10	106
4.6 Installing the Smart Meter	108
5 System Wirings	109
5.1 System Wiring Electrical Block Diagram	109
5.2 Detailed System Wiring Diagram	112
5.2.1 Detailed System Wiring Diagram for Single Inverter	113
5.2.2 Detailed System Wiring Diagram for Parallel System	118
5.3 Preparing Materials	121
5.3.1 Preparing Breakers	122
5.3.2 Preparing Cables	124

5.4 dismantle Inverter Lower Cover of Enclosure	131
5.5 Connecting the PE cable	132
5.6 Connecting the AC Cable	134
5.7 Connecting the PV Cable	136
5.8 Connecting the Battery Cable	138
5.8.1 Connecting the Power Cable between the Inverter and Battery	175
5.8.2 Connecting the Communication Cable between the Inverter and Battery	180
5.9 Connecting the Meter Cable	183
5.10 Connecting the Inverter Communication Cable	185
5.11 Lower cover of the Installing the Inverter enclosure	190
5.12 Installing the Battery System Protection cover	190
5.12.1 LX A5.0-30	190
5.12.2 GW14.3-BAT-LV-G10	191
5.12.3 LX U5.0-30	191
5.12.4 GW16.1-BAT-LV-G10	191
6 System Commissioning	193
6.1 Check Before Power ON	193
6.2 Power ON	193
6.3 Indicators	196
6.3.1 Inverter Indicators	196
6.3.2 Battery Indicators	197

6.3.2.1 LX A5.0-30	197
6.3.2.2 LX A5.0-30、LX U5.0-30	198
6.3.2.3 GW14.3-BAT-LV-G10	199
6.3.2.4 GW16.1-BAT-LV-G10	201
6.3.3 Smart Meter Indicator	203
6.3.4 Smart Dongle Indicator	204
7 System Commissioning	207
7.1 Configuration via LCD	207
7.1.1 LCD Overview	207
7.1.2 Parallel system configuration	210
7.1.3 Quick Settings	211
7.1.4 Setting Advanced Parameters	219
7.1.5 Setting Immediate Charging	220
7.1.6 Setting the Basic Information	221
7.1.7 Setting Port Connection	222
7.1.8 Viewing Device Information	226
7.2 SolarGo APP	227
7.2.1 App Introduction	227
7.2.1.1 Download the Installation App	227
7.2.1.2 Connection method	228
7.2.1.3 Login Interface Introduction	229
7.2.2 Connect hybrid inverter (Bluetooth)	231

7.2.3 hybrid inverter Interface Introduction	232
7.2.4 Set communication parameters	234
7.2.4.1 Configure privacy and security parameters	234
7.2.4.2 Configure WLAN/LAN parameters	237
7.2.4.3 Set RS485 communication parameters	239
7.2.4.4 Detect WLAN	239
7.2.5 Configure RS485 parallel system	240
7.2.6 System Quick Settings	241
7.2.6.1 System Quick Settings (Type II)	242
7.2.7 Setting the Basic Information	248
7.2.7.1 Set up lightning protection alarm function	248
7.2.7.2 Set backup power parameters	249
7.2.7.3 Enable shadow scan function	251
7.2.7.4 Set Power scheduling parameters	252
7.2.8 Setting Advanced Parameters	255
7.2.8.1 Set three-phase unbalanced output	255
7.2.8.2 Set the BACK-UP N and PE relay switch	256
7.2.8.3 Configure DRED/Remote Shutdown/RCR/EnWG 14a functions	257
7.2.8.4 Set Export power limit parameters	258
7.2.8.4.1 Set Export power limit parameters (General)	258
7.2.8.5 Enable AFCI Detection function	259
7.2.8.6 Set Power Dispatch Response parameters	260

7.2.8.7 Set custom safety compliance parameters	262
7.2.8.7.1 Set reactive power curve	263
7.2.8.7.2 Set active power curve	267
7.2.8.7.3 Set Grid Protection Parameters	273
7.2.8.7.4 Configure Utility grid connection parameters	274
7.2.8.7.5 Set voltagefault ride-through parameters	276
7.2.8.7.6 Set Frequencyfault ride-through parameters	278
7.2.8.8 Set PVAccess Mode	278
7.2.8.9 Enable unbalanced voltage output function	279
7.2.8.10 Restore factory settings	280
7.2.8.11 Export parameters	281
7.2.8.11.1 Export safety parameters	281
7.2.8.11.2 Export log parameters	282
7.2.9 Enable Battery function	283
7.2.9.1 Set lithium Battery parameters	283
7.2.9.2 Set lead-acid Battery parameters	287
7.2.10 Set meter parameters	290
7.2.10.1 Meter/CT Auxiliary Detection	291
7.2.11 Set generator/load control parameters	291
7.2.11.1 Set load control parameters	291
7.2.11.2 Set generator parameters	294
7.2.11.3 Set microgrid parameters	297

7.2.12 Equipment Maintenance	299
7.2.12.1 View firmware information/Firmware upgrade	299
7.2.12.1.1 Conventional Upgrade Firmware	299
7.2.12.1.2 One-touch Upgrade Firmware	301
7.2.12.1.3 automatic Upgrade Firmware	303
7.2.12.1.4 View firmware information	304
7.2.12.2 Modify login password	305
8 System Commissioning and Power Plant Monitoring	307
8.1 Set Inverter parameters via the App	307
8.1.1 Download the InstallationSEMS+ App	307
8.2 Conduct Power Plant Monitoring via SEMS+ WEB	308
9 Maintenance	309
9.1 Power OFF the System	309
9.2 Removing the Equipment	311
9.3 Disposing of the Equipment	311
9.4 Routine Maintenance	311
9.5 fault	313
9.5.1 Viewing Fault/Alarms Information	313
9.5.2 Fault Information and Troubleshooting	314
9.5.2.1 System fault	314
9.5.2.2 Inverter fault	315
9.5.2.2.1 Troubleshooting (fault code F01-F40)	315

9.5.2.2.2 Troubleshooting (fault code F41-F80)	333
9.5.2.2.3 Troubleshooting (fault code F81-F121)	342
9.5.2.2.4 Troubleshooting (fault code F122-F163)	354
9.5.2.2.5 fault phenomenon handling	363
9.5.2.3 Batteryfault(LX A5.0-30, LX U5.0-30)	382
9.5.2.4 Batteryfault(GW14.3-BAT-LV-G10)	386
9.5.2.5 Batteryfault(GW16.1-BAT-LV-G10)	389
9.5.3 fault Post-clearing Processing	392
9.5.3.1 Clear AFCI Failure WARNING	392
10 technical parameter	394
10.1 Inverter Parameters	394
10.2 Battery Technical Data	420
10.2.1 LX A5.0-30	420
10.2.2 LX U5.0-30	421
10.2.3 GW14.3-BAT-LV-G10	423
10.2.4 GW16.1-BAT-LV-G10	425
10.3 Smart Meter Technical Data	427
10.3.1 GM330	427
10.4 Smart Dongle Technical Data	428
10.4.1 WiFi/LAN Kit-20	428
10.4.2 4G Kit-CN-G20	429
10.4.3 4G Kit-G20	430

11 Appendix	432
11.1 FAQ	432
11.1.1 How to perform Meter/CT Auxiliary Detection?	432
11.1.2 How to Upgrade the Device Version	432
11.2 Abbreviations	433
11.3 Explanation of Terms	436
11.4 Battery SN code meaning	437
11.5 National Safety Regulations	438

1 Safety Precautions

Please always adhere to the safety precautions information contained in this document when operating the equipment.

WARNING

The device has been strictly designed and tested in compliance with safety regulations. However, as an electrical device, relevant safety instructions must be followed before performing any operations. Improper handling may result in serious injury or property damage.

1.1 General Safety

NOTICE

- Due to product version upgrades or other reasons, the document content will be updated periodically. Unless otherwise agreed, the document content cannot replace the safety precautions on product labels. All descriptions in the document are for guidance only.
- Please read this document carefully before installing the device to understand the product and precautions.
- All operations on the device must be performed by professional, qualified electrical technicians who are familiar with the relevant standards and safety regulations at the project location.
- When operating the device, use insulated tools and wear personal protective equipment to ensure personal safety. When handling electronic components, wear anti-static gloves, anti-static wrist straps, anti-static clothing, etc., to protect the device from electrostatic damage.
- Unauthorized disassembly or modification may cause device damage, and such damage is not covered by the warranty.
- Device damage or personal injury caused by not installing, using, or configuring the device according to this document or the corresponding user manual is beyond the manufacturer's liability. For more product warranty information, please visit the official website: <https://en.goodwe.com/warrantyrelated.html>.

1.2 personnel requirements

NOTICE

To ensure safety, compliance, and efficiency throughout the entire process of equipment transportation, installation, wiring, operation, and maintenance, all work must be performed by professionals or qualified personnel.

1. Professionals or qualified personnel include:
 - Personnel who have mastered knowledge related to equipment working principles, system structure, risks, and hazards, and have received professional operation training or possess extensive practical experience.
 - Personnel who have received relevant technical and safety training, possess certain operational experience, are aware of potential dangers specific tasks may pose to themselves, and can take protective measures to minimize risks to themselves and others.
 - Qualified electrical technicians who meet the regulatory requirements of the country/region where they are located.
 - Personnel holding a degree in electrical engineering/an advanced diploma in electrical disciplines or equivalent/possessing professional qualifications in the electrical field, with at least 2/3/4 years of experience in testing and regulatory work using electrical equipment safety standards.
2. Personnel involved in special tasks such as electrical work, work at heights, and special equipment operation must hold valid qualification certificates required by the location where the equipment is situated.
3. Operation of medium-voltage equipment must be performed by certified high-voltage electricians.
4. Replacement of equipment and components is only permitted to be carried out by authorized personnel.

1.3 System Safety



- Before making electrical connections, disconnect all upstream switches of the equipment to ensure it is powered off. Live operation is strictly prohibited, as it may lead to hazards such as electric shock.
- To prevent personal injury or equipment damage caused by live operation, a circuit breaker must be added to the voltage input side of the equipment.
- All operations, including transportation, storage, installation, operation, use, and maintenance, must comply with applicable laws, regulations, standards, and specification requirements.
- The specifications of cables and components used for electrical connections must comply with local laws, regulations, standards, and specification requirements.
- Please use the cable connectors provided in the package to connect the equipment cables. If other models of connectors are used, any resulting equipment damage is not within the manufacturer's liability.
- Ensure all cables of the equipment are connected correctly, securely, and without looseness. Improper wiring may cause poor contact or damage the equipment.
- The equipment's protective grounding wire must be securely connected.
- To protect the equipment and its components from damage during transportation, ensure that transport personnel are professionally trained. Record the operation steps during transportation and keep the equipment balanced to avoid dropping.
- The equipment is heavy. Please allocate personnel according to the equipment's weight to prevent it from exceeding the human handling capacity, which could cause injury.
- Ensure the equipment is placed stably and not tilted. Toppling of the equipment may cause equipment damage and personal injury.



- During equipment installation, avoid subjecting the terminal blocks to weight, as this may cause damage to the terminals.
- If the cable is subjected to excessive tension, it may lead to poor connections. When wiring, leave a certain length of cable slack before connecting it to the equipment's terminal ports.
- Cables of the same type should be bundled together. Cables of different types should be routed at least 30mm apart and must not be intertwined or cross-routed.
- Using cables in high-temperature environments may cause insulation aging and damage. Maintain a distance of at least 30mm between cables and heat-generating components or the periphery of heat source areas.

1.3.1 PV String Safety

WARNING

- Ensure the component frame and mounting system are properly grounded.
- After completing the DC cable connection, ensure the connections are tight and secure with no looseness. Improper connection may lead to poor contact or high impedance, and damage the inverter.
- Use a multimeter to measure the positive and negative poles of the DC cable to ensure correct polarity and no reverse connection; and that the voltage is within the allowable range.
- Use a multimeter to measure the DC cable to ensure correct polarity and no reverse connection; the voltage should be lower than the maximum DC input voltage. Damage caused by reverse connection and overvoltage is not covered by the equipment manufacturer's liability.
- PV string output does not support grounding. Before connecting the PV string to the inverter, ensure the minimum insulation resistance to ground of the PV string meets the minimum insulation impedance requirement ($R = \text{Max. Input Voltage (V)} / 30\text{mA}$).
- Do not connect the same PV string to multiple inverters, as this may cause inverter damage.
- The photovoltaic modules used with the inverter must comply with IEC 61730 Class A standard.
- When the PV string input voltage or input current is high, it may cause the inverter output power to derate.

1.3.2 Inverter Safety

WARNING

- Ensure the voltage and frequency at the grid connection point comply with the inverter's grid-connection specifications.
- It is recommended to add protective devices such as circuit breakers or fuses on the AC side of the inverter. The rating of the protective device must be greater than 1.25 times the inverter's maximum AC output current.
- If the inverter triggers an arc fault alarm less than 5 times within 24 hours, the alarm can be cleared automatically. After the 5th arc fault alarm, the inverter will shut down for protection. The inverter can resume normal operation only after the fault is cleared.
- If the photovoltaic system is not configured with a battery, using the BACK-UP function is not recommended, as it may cause a risk of system power outage.
- Changes in grid voltage and frequency may cause the inverter's output power to derate.

1.3.3 Battery Safety

DANGER

- Before operating any equipment within the system, ensure the equipment is powered off to avoid the risk of electric shock. During equipment operation, strictly adhere to all safety precautions in this manual and the safety markings on the equipment.
- Do not disassemble, modify, or repair the battery or control box without official authorization from the equipment manufacturer, otherwise there is a risk of electric shock or equipment damage. Losses resulting from such actions are beyond the manufacturer's liability.
- Do not impact, pull, drag, squeeze, or step on the equipment, and do not place the battery in fire, otherwise there is a risk of battery explosion.
- Do not place the battery in high-temperature environments. Ensure there are no heat sources near the battery and that it is not exposed to direct sunlight. If the ambient temperature exceeds 60°C, a fire may occur.
- Do not use the battery or control box if there are obvious defects, cracks, damage, or other issues. Battery damage may cause electrolyte leakage.
- Do not move the battery system while it is operating. If battery replacement or addition is required, please contact the after-sales service center.
- A battery short circuit may cause personal injury. The instantaneous high current from a short circuit can release a large amount of energy, potentially causing a fire.
- The battery DC circuit breaker should comply with the requirements of the AS/NZS 5139 standard.

WARNING

- Battery current may be affected by some factors, such as: temperature, Humidity, weather conditions, etc., which may cause battery current limiting, affecting load capacity.
- If the battery cannot start, please contact the after-sales service center as soon as possible. Otherwise, the battery may be permanently damaged.
- Please regularly inspect and maintain the battery according to the battery's maintenance requirements.

- Battery electrolyte leakage

If a battery module leaks electrolyte, avoid contact with the leaked liquid or gas. Electrolyte is corrosive, and contact may cause skin irritation and chemical burns. If you accidentally come into contact with the leaked substance, please do the following:

 - inhalation: Evacuate from the contaminated area and seek immediate medical assistance.
 - Eye contact: Rinse with clean water for at least 15 minutes and seek immediate medical assistance.
 - Skin contact: Wash the affected area thoroughly with soap and water and seek immediate medical assistance.
 - Ingestion: Induce vomiting and seek immediate medical assistance.
- Fire
 - When the battery temperature exceeds 150°C, there is a risk of fire. A battery fire may release toxic and harmful gases.
 - To prevent fire, ensure carbon dioxide, Novec1230, or FM-200 fire extinguishers are available near the equipment.
 - When fighting a fire, do not use ABC dry powder fire extinguishers. Firefighters must wear protective clothing and self-contained breathing apparatus.
- Battery triggers fire protection

For batteries equipped with optional fire protection functions, after the fire protection function is triggered, perform the following actions:

 - Immediately cut off the main power switch to ensure no current is flowing through the battery system.
 - Conduct a preliminary visual inspection of the battery for any damage, deformation, leakage, or unusual odor. Inspect the battery casing, connectors, and cables.
 - Use temperature sensors to detect the temperature of the battery and its surroundings, ensuring there is no overheating risk.
 - Isolate and label the damaged battery, and dispose of it properly according to local regulations.

1.3.4 Smart Meter Safety





WARNING











If the grid voltage fluctuation exceeds 265V, long-term overvoltage operation may damage the electric meter. It is recommended to add a fuse with a rated current of 0.5A on the voltage input side of the meter to protect it.



1.4 Safety Symbols and Certification Marks

DANGER

- After the equipment is installed, the labels and warning signs on the cabinet must be clearly visible, and must not be obscured, altered, or damaged.
- The following cabinet warning label descriptions are for reference only, please refer to the actual labels used on the equipment.

No.	Symbol	Meaning
1		Potential hazards exist during equipment operation. Take protective measures when operating the equipment.
2		High voltage hazard. High voltage is present during equipment operation. Ensure the equipment is powered off before performing any operations.
3		The inverter surface is at high temperature. Do not touch during operation to avoid burns.
4		Use the equipment properly. There is a risk of explosion under extreme conditions.
5		Battery contains flammable materials. Beware of fire.

No.	Symbol	Meaning
6		The equipment contains corrosive electrolyte. Avoid contact with leaking electrolyte or vapor.
7		Delayed discharge. After powering off the equipment, wait for 5 minutes until it is fully discharged.
8		Keep the equipment away from open flames or ignition sources.
9		Keep the equipment out of reach of children.
10		Do not extinguish with water.
11		Read the product manual carefully before operating the equipment.
12		Wear personal protective equipment during installation, operation, and maintenance.
13		Do not dispose of the equipment as household waste. Dispose of it according to local laws and regulations, or return it to the manufacturer.
14		Grounding point.
15		Recycling symbol.

No.	Symbol	Meaning
16		CE certification mark.
17		TUV mark.
18		RCM mark.

1.5 EU Declaration of Conformity

1.5.1 Equipment with Wireless Communication Modules

Equipment with Wireless Communication Modules that can be sold in the European market meets the following directive requirements:

- Radio Equipment Directive 2014/53/EU (RED)
- Restrictions of Hazardous Substances Directive 2011/65/EU and (EU) 2015/863 (RoHS)
- Waste Electrical and Electronic Equipment 2012/19/EU
- Registration, Evaluation, Authorization and Restriction of Chemicals (EC) No 1907/2006 (REACH)

1.5.2 Equipment without Wireless Communication Modules (Except Battery)

Equipment without wireless communication functions that can be sold in the European market must meet the requirements of the following directives:

- Electromagnetic compatibility Directive 2014/30/EU (EMC)
- Electrical Apparatus Low Voltage Directive 2014/35/EU (LVD)
- Restrictions of Hazardous Substances Directive 2011/65/EU and (EU) 2015/863 (RoHS)
- Waste Electrical and Electronic Equipment 2012/19/EU
- Registration, Evaluation, Authorization and Restriction of Chemicals (EC) No

1907/2006 (REACH)

1.5.3 Battery

Batteries that can be sold in the European market meet the following directive requirements:

- Electromagnetic compatibility Directive 2014/30/EU (EMC)
- Electrical Apparatus Low Voltage Directive 2014/35/EU (LVD)
- Restrictions of Hazardous Substances Directive 2011/65/EU and (EU) 2015/863 (RoHS)^{*1}
- Regulation (EU) 2023/1542 Article 12 - Safety of stationary battery energy storage systems
- Regulation (EU) 2023/1542 Article 10 - Performance and durability requirements for rechargeable industrial batteries, LMT batteries and electric vehicle batteries
- Regulation (EU) 2023/1542 Article 14 - Information on the state of health and expected lifetime of batteries
- Waste Electrical and Electronic Equipment 2012/19/EU
- Registration, Evaluation, Authorization and Restriction of Chemicals (EC) No 1907/2006 (REACH)

*1: Our company's battery products meet the hazardous substance limit requirements specified in this regulation.

For more EU conformity declarations, please visit the [official website](#).

2 System Introduction

2.1 System Overview

The residential Smart Inverter Solution integrates devices such as inverters, Battery, Smart Meter, and smart communication sticks. In a photovoltaic system, it converts solar energy into electricity to meet household power demands. The energy IoT devices in the system manage electrical appliances by identifying the overall power situation within the system, thereby intelligently managing power for supplying loads, storing it in the Battery, or exporting it to the grid.

WARNING

- The energy storage system is not suitable for connecting devices that rely on stable power supply, such as life-sustaining medical equipment, etc. Please ensure that when the system loses power, it does not cause personal injury.
- Select the battery model based on the inverter and battery matching list. For requirements on batteries used in the same system, such as whether models can be mixed, whether capacities are consistent, etc., please refer to the battery user manual of the corresponding model or contact the battery manufacturer for relevant requirements. Inverter and battery compatibility list:
https://en.goodwe.com/Ftp/EN/Downloads/User%20Manual/GW_Battery%20Compatibility%20Overview-EN.pdf.
- Due to product version upgrades or other reasons, the document content will be updated periodically. The matching relationship between inverters and IoT products can be referred to:
https://en.goodwe.com/Ftp/EN/Downloads/User%20Manual/GW_Compatibility-list-of-GoodWe-inverters-and-IoT-products-EN.pdf.
- In a system where the inverter operates completely off-grid, if the battery is in low light or rainy weather for a long time and fails to replenish power in time, it may lead to over-discharge, causing battery performance degradation or damage. To ensure long-term stable operation of the system, avoid completely draining the battery. Recommended measures are as follows:
 1. When operating off-grid, set the minimum SOC protection threshold. It is recommended to set the off-grid battery SOC lower limit to 30%.
 2. When the SOC approaches the protection threshold, the system will automatically enter load limiting or protection mode.
 3. If there is insufficient light for several consecutive days and the battery SOC is too low, promptly replenish the battery with external energy sources (such as a generator or grid-assisted charging).
 4. Regularly check the battery status to ensure it is within the safe operating range.
 5. It is recommended to fully charge and discharge the battery every six months to calibrate the SOC accuracy.
- For detailed networking and wiring schemes for each scenario, please refer to:
[5.2.Detailed System Wiring Diagram\(Page 112\)](#).

When the energy storage system is in off-grid mode, it can normally supply power to the following loads:

BACK-UP Port Off-Grid Load Capacity Specifications

Inverter Model	GW5K-ET-L-G10 GW6K-ET-L-G10 GW8K-ET-L-G10 GW10K-ET-L-G10 GW12K-ET-L-G10 GW12K-ET-LL-G10	GW15K-ET-L-G10 GW20K-ET-L-G10		
Load Type	Single-Phase	Three-Phase	Single-Phase	Three-Phase
Single Inductive Load Rated Power (kVA)	1.1	3.3	2.2	6.6
Total Rated Power of Multiple Inductive Loads (kVA)	$0.4 \cdot P_n / 3$	$0.4 \cdot P_n$	$0.5 \cdot P_n / 3$	$0.5 \cdot P_n$
Capacitive Load (kVA)	$0.33 P_n / 3$	$0.33 P_n$	$0.33 P_n / 3$	$0.33 P_n$
Half-Wave Load (kW)	3	-	3	-

Note:

- P_n : Inverter rated output power.
- For 2 or more units in parallel, the allowed total inductive load rated power = Single inductive load rated power * Number of parallel units * 80%.
- Half-wave load: Some older or non-EMC compliant appliances (e.g., hair dryers, small heaters using half-wave rectification).
- If the calculated total power of multiple inductive loads based on rated power is less than the single inductive load rated power, then the total rated power of multiple inductive loads = single inductive load rated power.
- It is recommended to use a frequency converter when carrying inductive loads.

General Scenario

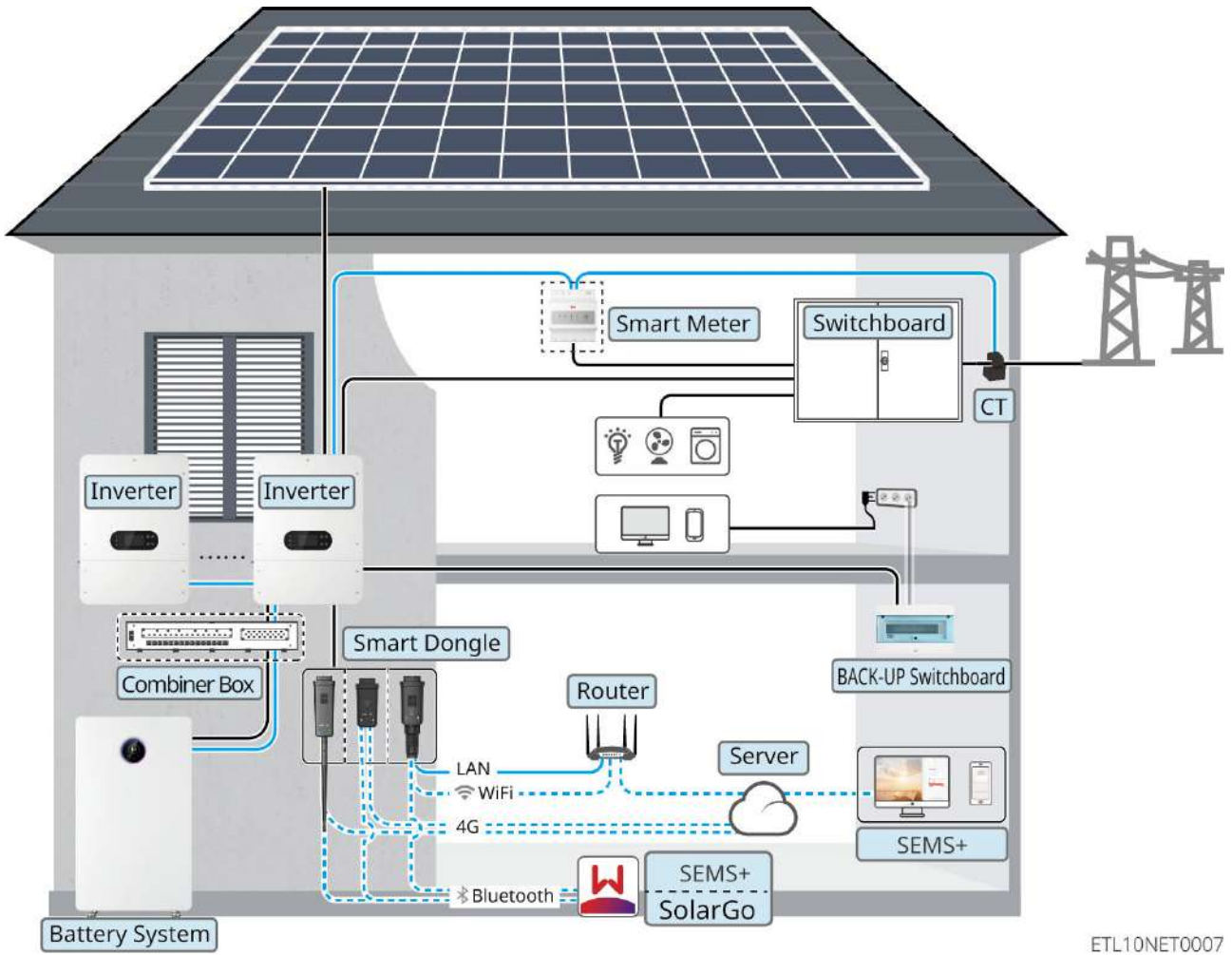

ETL10NET0007

Device Type	model	Description
Inverter	GW5K-ET-L-G10 GW6K-ET-L-G10 GW8K-ET-L-G10 GW10K-ET-L-G10 GW12K-ET-L-G10 GW15K-ET-L-G10 GW20K-ET-L-G10 GW12K-ET-LL-G10	<ul style="list-style-type: none"> • The Inverter supports connection to a generator or large loads. • GW5K-ET-L-G10, GW6K-ET-L-G10, GW8K-ET-L-G10, GW10K-ET-L-G10, GW12K-ET-L-G10, GW12K-ET-LL-G10 only support connection to a single battery string. • GW15K-ET-L-G10, GW20K-ET-L-G10 support connection to dual battery strings. • The system supports a maximum of 10 inverters to form a parallel system, supporting mixed parallel connection of inverters with different power ratings in on-grid/off-grid modes; microgrid function is not supported in parallel operation. • In a parallel system, if models with different power ratings are mixed, please set the higher-power model as the master inverter. • For parallel system networking, please use the GM330 Smart Meter. • In a parallel system, each inverter needs to be installed with a WiFi/LAN Kit-20 or 4G Kit-CN-G20. The software version requirement for WiFi/LAN Kit-20 is V2.5 or above, and for 4G Kit-CN-G20 is version 08 or above. • All inverters must have the same software version for parallel system networking. • Inverter software version requirements: <ul style="list-style-type: none"> ◦ Inverter ARM software version must be 11.18 or above. ◦ Inverter DSP software version must be 11.12 or above.

Device Type	model	Description
Battery system	LX A5.0-30	<ul style="list-style-type: none"> • Battery systems of different models cannot be mixed. Cluster expansion between different models is currently not supported. Cluster expansion is allowed within one year of purchase for the same model, but not allowed after one year. • A single system supports a maximum of 30 battery units in a cluster.
	GW14.3-BAT-LV-G10	<ul style="list-style-type: none"> • Cluster expansion between different models is currently not supported. Cluster expansion is allowed within one year of purchase for the same model, but not allowed after one year. • A single system supports a maximum of 30 units in a cluster: <ul style="list-style-type: none"> ◦ Products with SN code 25C and later default to supporting 30-unit clusters. ◦ For products before 25C to support 30-unit clusters, please contact GoodWe After-Sales Service Center to upgrade the firmware version. ◦ Refer to 11.4.SN Code Meaning(Page 437) for viewing product SN codes.
	LX U5.0-30	<ul style="list-style-type: none"> • A single system supports a maximum of 30 units in a cluster. • Cluster expansion between different models is currently not supported. Cluster expansion is allowed within one year of purchase for the same model, but not allowed after one year.

Device Type	model	Description
	GW16.1-BAT-LV-G10	<ul style="list-style-type: none"> • A single system supports a maximum of 30 units in a cluster. • Cluster expansion between different models is currently not supported. Cluster expansion is allowed within one year of purchase for the same model, but not allowed after one year.
	Lead-acid Battery	<ul style="list-style-type: none"> • Supports connection to AGM, GEL, and Flooded types of lead-acid batteries. • Calculate the number of batteries that can be connected in series based on the lead-acid battery voltage. The total voltage of the series-connected batteries must not exceed 60V.
Combiner Box	BCB-22-WW-0 BCB-32-WW-0 BCB-33-WW-0 (Purchased from GoodWe)	<p>Please select the combiner box according to the inverter's charge/discharge capability, load size, and battery charge/discharge capability in the system.</p> <ul style="list-style-type: none"> • BCB-22-WW-0: <ul style="list-style-type: none"> ◦ When used with LX A5.0-30, the battery system supports up to 720A operating current, 36kW operating power, maximum connection of 6 inverters, and 6 battery units. ◦ When used with LX U5.0-30, the battery system supports up to 720A operating current, 36kW operating power, maximum connection of 6 inverters, and 6 battery units. • BCB-32-WW-0: <ul style="list-style-type: none"> ◦ When used with LX A5.0-30, the battery system supports up to 720A operating current, 36kW operating power, maximum connection of 6 inverters, and 15 battery units.

Device Type	model	Description
		<ul style="list-style-type: none"> ◦ When used with LX U5.0-30, the battery system supports up to 720A operating current, 36kW operating power, maximum connection of 6 inverters, and 8 battery units. ◦ When used with GW14.3-BAT-LV-G10, the battery system supports up to 720A operating current, 36kW operating power, maximum connection of 6 inverters, and 15 battery units. ◦ When used with GW16.1-BAT-LV-G10, the battery system supports up to 720A operating current, 36kW operating power, maximum connection of 6 inverters, and 15 battery units. • BCB-33-WW-0: <ul style="list-style-type: none"> ◦ When used with LX U5.0-30, the battery system supports up to 720A operating current, 36kW operating power, maximum connection of 6 inverters, and 15 battery units. When the number of battery units exceeds 8, two 600A fuses need to be connected in parallel. • Others: Please configure according to the system power and current.

Device Type	model	Description
Smart Meter	<ul style="list-style-type: none"> • Built-in meter (shipped with the inverter) • GM330 (Purchased from GoodWe) 	<ul style="list-style-type: none"> • Built-in meter: Please use the CT shipped with the unit to connect to the inverter. <ul style="list-style-type: none"> ◦ CT ratio is 120A:40mA. ◦ If the inverter's built-in meter does not meet the requirements, you can contact dealers to purchase the GM330 Smart Meter. • GM330: CT can be purchased from GoodWe or independently. CT ratio requirement: nA/5A <ul style="list-style-type: none"> ◦ nA: CT primary side input current, where n ranges from 200 to 5000. ◦ 5A: CT secondary side output current.
Smart dongle	WiFi/LAN Kit-20	<ul style="list-style-type: none"> • Applicable for single inverter networking and parallel inverter networking scenarios. • Uses Bluetooth signal for local configuration of device parameters and viewing device operation information, and uses WiFi or LAN to upload system operation information to the monitoring platform. • To use one-click upgrade, operation log export, parallel function, etc., on the inverter, ensure the WiFi/LAN Kit-20 software version is V2.5 or above.

Device Type	model	Description
	4G Kit-CN-G20 (China only)	<ul style="list-style-type: none"> • Applicable for single inverter networking and parallel inverter networking scenarios. • Uses Bluetooth signal for local configuration of device parameters and viewing device operation information, and uses 4G to upload system operation information to the monitoring platform. • To use one-click upgrade, operation log export, parallel function, etc., on the inverter, ensure the 4G Kit-CN-G20 version is version 08 or above.
	4G Kit-G20	<ul style="list-style-type: none"> • Applicable for single inverter networking scenarios. • Uses Bluetooth signal for local configuration of device parameters and viewing device operation information, and uses 4G to upload system operation information to the monitoring platform.
Large Load	-	<p>Only single-unit scenario supports SG Ready heat pump connection, controlling the heat pump via dry contact signal.</p> <ol style="list-style-type: none"> 1. Total power of large loads < Maximum output power of GEN port. 2. Large load power + BACK-UP power < Maximum AC input power (Utility grid).
Generator	-	Generator power must be greater than the total power of all loads on the BACKUP port.

WARNING

- In the Microgrid Scenario, it is recommended that the PV open-circuit voltage of the hybrid PV-storage inverter be $< 0.85 * \text{the maximum PV input voltage}$ to avoid triggering overvoltage protection due to excessive system voltage under severe working conditions.
- If the system is in a high-temperature environment or under BMS current limiting, battery charging power may be restricted, which could lead to excessive system voltage and trigger overvoltage protection.
- In the Microgrid Scenario, ensure the over-frequency power reduction point of the grid-tied inverter matches that of the hybrid PV-storage inverter.
- If output power limitation is required for the grid-tied inverter, please connect it separately to devices such as an energy meter or CT.
- Ensure the over-frequency power reduction curve of the grid-tied inverter is configured as follows:
 - Set the end power to 0% P_n
 - Set the response delay time to 0
 - Set the hysteresis function enable to OFF

Microgrid Scenario

When a grid-tied inverter is connected to the GEN port of the hybrid inverter, it constitutes a Microgrid Scenario.

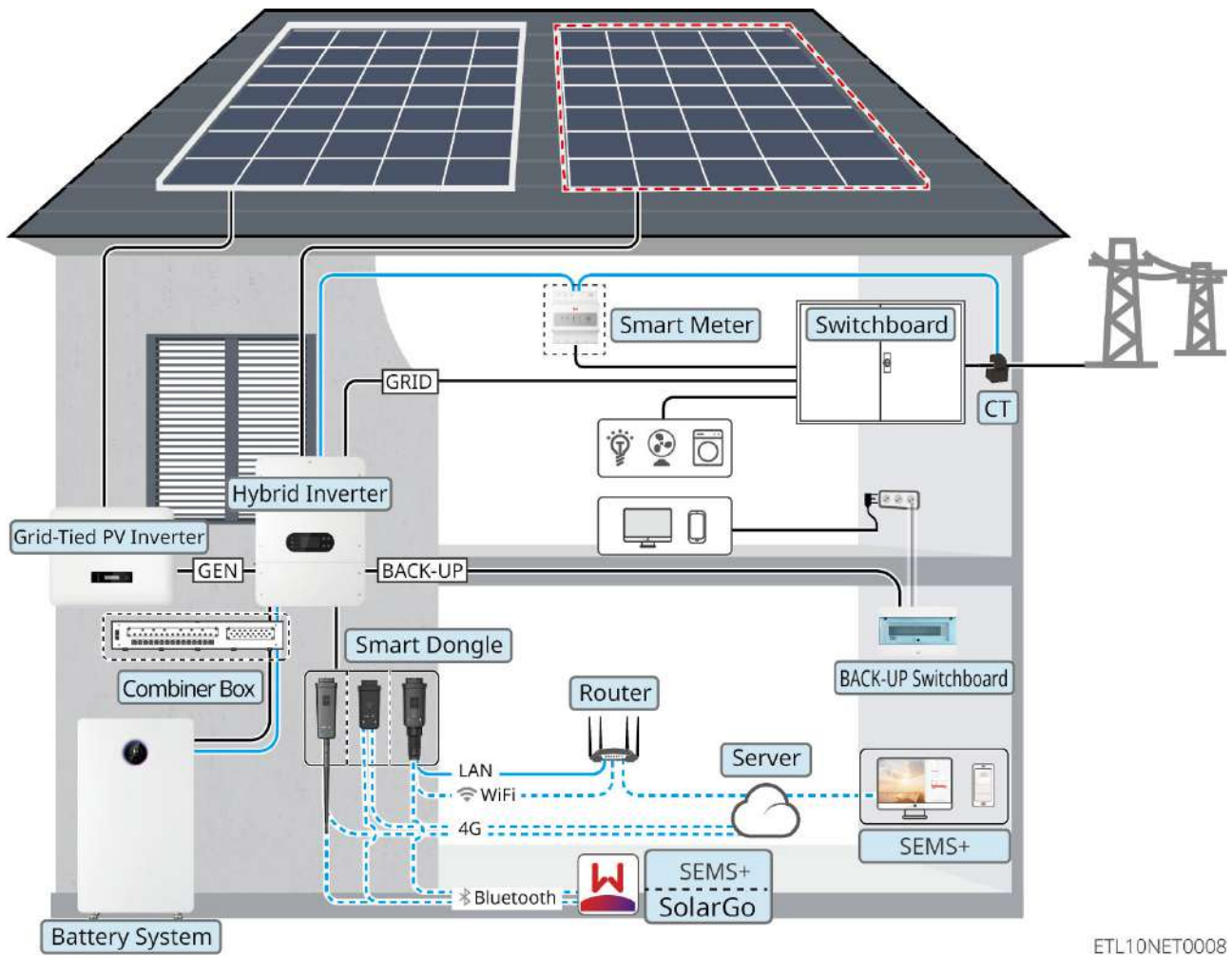

ETL10NET0008

Device Type	model	Description
Hybrid Inverter	GW5K-ET-L-G10 GW6K-ET-L-G10 GW8K-ET-L-G10 GW10K-ET-L-G10 GW12K-ET-L-G10 GW15K-ET-L-G10 GW20K-ET-L-G10 GW12K-ET-LL-G10	<ul style="list-style-type: none"> • In a microgrid scenario, only one Hybrid Inverter is supported in the system. • GW5K-ET-L-G10, GW6K-ET-L-G10, GW8K-ET-L-G10, GW10K-ET-L-G10, GW12K-ET-L-G10, GW12K-ET-LL-G10 only support connection to a single battery string. • GW15K-ET-L-G10, GW20K-ET-L-G10 support connection to dual battery strings. • In a microgrid scenario, connection to a generator is not supported. • Microgrid functionality is not supported when inverters are paralleled.

Device Type	model	Description
Battery system	LX A5.0-30	<ul style="list-style-type: none"> • Battery systems of different models cannot be mixed. Cluster expansion between different models is currently not supported. Cluster expansion is allowed for the same model within one year of customer purchase and use, and is not allowed after one year. • A maximum of 30 battery units in a cluster is supported in a single system.
	GW14.3-BAT-LV-G10	<ul style="list-style-type: none"> • Cluster expansion between different models is currently not supported. Cluster expansion is allowed for the same model within one year of customer purchase and use, and is not allowed after one year. • A maximum cluster of 30 units is supported in a single system: <ul style="list-style-type: none"> ◦ Products with SN code 25C and later default to supporting a 30-unit cluster. ◦ For products before 25C to meet the 30-unit cluster requirement, please contact GoodWe After-Sales Service Center to upgrade the firmware version. ◦ Refer to 11.4.SN Code Meaning(Page 437) for checking product SN code.
	LX U5.0-30	<ul style="list-style-type: none"> • A maximum cluster of 30 units is supported in a single system. • Cluster expansion between different models is currently not supported. Cluster expansion is allowed for the same model within one year of customer purchase and use, and is not allowed after one year.

Device Type	model	Description
	GW16.1-BAT-LV-G10	<ul style="list-style-type: none"> • A maximum cluster of 30 units is supported in a single system. • Cluster expansion between different models is currently not supported. Cluster expansion is allowed for the same model within one year of customer purchase and use, and is not allowed after one year.
	Lead-acid Battery	<ul style="list-style-type: none"> • Supports connection of AGM, GEL, and Flooded type lead-acid batteries. • Calculate the number of batteries that can be connected in series based on the lead-acid battery voltage. The total voltage of the series-connected batteries must not exceed 60V.
Combiner Box	BCB-22-WW-0 BCB-32-WW-0 BCB-33-WW-0 (Purchased from GoodWe)	<p>Please select the combiner box based on the inverter's charge/discharge capability, load size, and battery charge/discharge capability in the system.</p> <ul style="list-style-type: none"> • BCB-22-WW-0: <ul style="list-style-type: none"> ◦ When used with LX A5.0-30, the battery system supports up to 720A working current, 36kW working power, maximum connection of 6 inverters, and 6 battery units. ◦ When used with LX U5.0-30, the battery system supports up to 720A working current, 36kW working power, maximum connection of 6 inverters, and 6 battery units. • BCB-32-WW-0: <ul style="list-style-type: none"> ◦ When used with LX A5.0-30, the battery system supports up to 720A working current, 36kW working power, maximum connection of 6 inverters, and 15 battery units.

Device Type	model	Description
		<ul style="list-style-type: none"> ◦ When used with LX U5.0-30, the battery system supports up to 720A working current, 36kW working power, maximum connection of 6 inverters, and 8 battery units. ◦ When used with GW14.3-BAT-LV-G10, the battery system supports up to 720A working current, 36kW working power, maximum connection of 6 inverters, and 15 battery units. ◦ When used with GW16.1-BAT-LV-G10, the battery system supports up to 720A working current, 36kW working power, maximum connection of 6 inverters, and 15 battery units. • BCB-33-WW-0: <ul style="list-style-type: none"> ◦ When used with LX U5.0-30, the battery system supports up to 720A working current, 36kW working power, maximum connection of 6 inverters, and 15 battery units. When the number of battery units exceeds 8, two 600A fuses need to be connected in parallel. • Others: Please configure according to system power and current.
Smart Meter	<ul style="list-style-type: none"> • Built-in meter (shipped with the inverter) • GM330 (Purchased from GoodWe) 	<ul style="list-style-type: none"> • Built-in meter: Please use the CT shipped with the inverter to connect to the inverter. <ul style="list-style-type: none"> ◦ CT ratio is 120A:40mA. ◦ If the inverter's built-in meter does not meet the usage requirements, you can contact dealers to purchase the GM330 Smart Meter. • GM330: CT can be purchased from GoodWe or separately. CT ratio requirement: nA/5A <ul style="list-style-type: none"> ◦ nA: CT primary side input current, where n ranges from 200 to 5000. ◦ 5A: CT secondary side output current.

Device Type	model	Description
Smart dongle	WiFi/LAN Kit-20	<ul style="list-style-type: none"> • Uses Bluetooth signal for local configuration of device parameters and viewing device operation information. Uploads system operation information to the monitoring platform via WiFi or LAN. • To use functions like one-click upgrade and operation log export on the inverter, ensure the WiFi/LAN Kit-20 software version is V2.5 or higher.
	4G Kit-CN-G20 (China only)	<ul style="list-style-type: none"> • Uses Bluetooth signal for local configuration of device parameters and viewing device operation information. Uploads system operation information to the monitoring platform via 4G. • To use one-click upgrade and operation log export functions on the inverter, ensure the 4G Kit-CN-G20 version is version 08 or higher.
	4G Kit-G20	<p>Uses Bluetooth signal for local configuration of device parameters and viewing device operation information. Uploads system operation information to the monitoring platform via 4G.</p>

Device Type	model	Description
grid-tied PV inverter	-	<ul style="list-style-type: none"> • GoodWe brand grid-tied PV inverters are recommended. Third-party grid-tied PV inverters are supported for use. • In a microgrid system, ensure the rated output power of the grid-tied PV inverter \leq the rated output power of the Hybrid Inverter. • When the microgrid system is in grid-tied mode, if power limitation is required, please ensure: <ul style="list-style-type: none"> ◦ For the Hybrid Inverter, set it in the App's Export power limit interface; for the grid-tied PV inverter, set it according to the actual tool used. ◦ To ensure the grid-tied PV inverter can continue to generate and operate, adjust the Hybrid Inverter's output power in the App's Microgrid Mode interface. <p>Note: The output power control accuracy varies among different grid-tied PV inverters. Please set the Export power limit parameter value according to the actual situation.</p>

Coupled Scenario

When a grid-tied inverter is connected to the ON-GRID port of the hybrid inverter, it constitutes a Coupled Scenario.

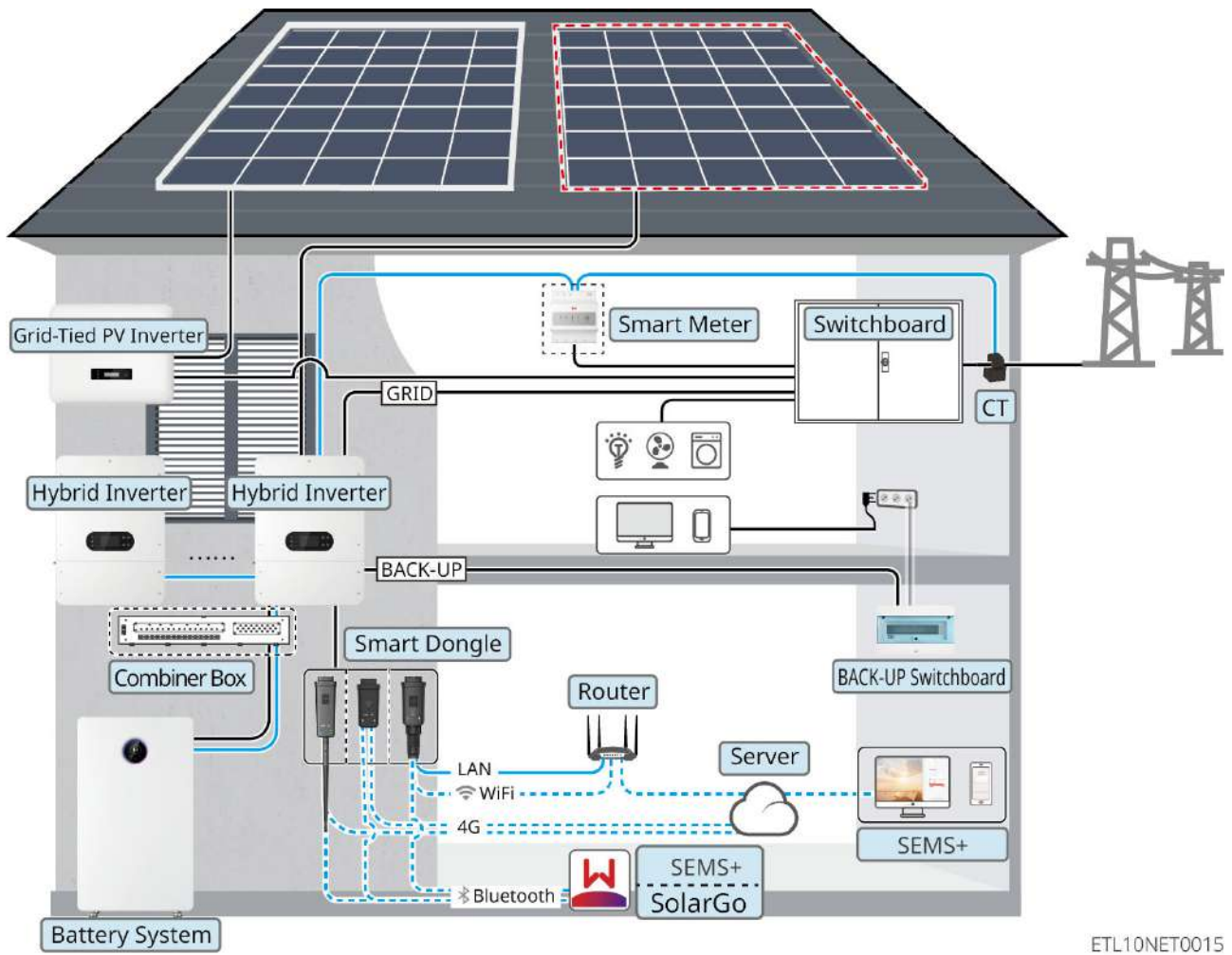

ETL10NET0015

Device Type	model	Description
Hybrid Inverter	GW5K-ET-L-G10 GW6K-ET-L-G10 GW8K-ET-L-G10 GW10K-ET-L-G10 GW12K-ET-L-G10 GW15K-ET-L-G10 GW20K-ET-L-G10 GW12K-ET-LL-G10	<ul style="list-style-type: none"> • The Inverter supports connection to a generator or large loads. • GW5K-ET-L-G10, GW6K-ET-L-G10, GW8K-ET-L-G10, GW10K-ET-L-G10, GW12K-ET-L-G10, and GW12K-ET-LL-G10 support connection to only a single battery string. • GW15K-ET-L-G10 and GW20K-ET-L-G10 support connection to dual battery strings. • The system supports a maximum of 10 inverters to form a parallel system, allowing parallel connection of inverters with different power ratings in both on-grid and off-grid modes. • In a parallel system, if inverters with different power ratings are used together, set the higher-power inverter as the master inverter. • For parallel system networking, use the GM330 Smart Meter. • In a parallel system, each inverter must be equipped with a WiFi/LAN Kit-20 or 4G Kit-CN-G20. The software version for WiFi/LAN Kit-20 must be V2.5 or above, and for 4G Kit-CN-G20 must be version 08 or above. • All inverter software versions must be consistent when forming a parallel network. • Inverter software version requirements: <ul style="list-style-type: none"> ◦ Inverter ARM software version must be 11.18 or above. ◦ Inverter DSP software version must be 11.12 or above.

Device Type	model	Description
Battery system	LX A5.0-30	<ul style="list-style-type: none"> • Battery systems of different models cannot be mixed. Clustering expansion between different models is currently not supported. Clustering expansion is allowed within one year of purchase for the same model; after one year, it is not allowed. • A single system supports clustering of up to 30 battery units.
	GW14.3-BAT-LV-G10	<ul style="list-style-type: none"> • Clustering expansion between different models is currently not supported. Clustering expansion is allowed within one year of purchase for the same model; after one year, it is not allowed. • A single system supports clustering of up to 30 units: <ul style="list-style-type: none"> ◦ Products with SN code 25C and later support clustering of 30 units by default. ◦ For products before 25C to support clustering of 30 units, contact GoodWe After-Sales Service Center to upgrade the firmware version. ◦ Refer to 11.4.SN Code Meaning(Page 437) to view the product SN code.
	LX U5.0-30	<ul style="list-style-type: none"> • A single system supports clustering of up to 30 units. • Clustering expansion between different models is currently not supported. Clustering expansion is allowed within one year of purchase for the same model; after one year, it is not allowed.

Device Type	model	Description
	GW16.1-BAT-LV-G10	<ul style="list-style-type: none"> • A single system supports clustering of up to 30 units. • Clustering expansion between different models is currently not supported. Clustering expansion is allowed within one year of purchase for the same model; after one year, it is not allowed.
	Lead-acid battery	<ul style="list-style-type: none"> • Supports connection to AGM, GEL, and Flooded type lead-acid batteries. • Calculate the number of batteries that can be connected in series based on the lead-acid battery voltage. The total voltage of the series-connected batteries must not exceed 60V.
Combiner Box	BCB-22-WW-0 BCB-32-WW-0 BCB-33-WW-0 (Purchased from GoodWe)	<p>Select the combiner box based on the inverter's charge/discharge capability, load size, and battery charge/discharge capability in the system.</p> <ul style="list-style-type: none"> • BCB-22-WW-0: <ul style="list-style-type: none"> ◦ When used with LX A5.0-30, the battery system supports a maximum working current of 720A, working power of 36kW, maximum connection of 6 inverters, and 6 battery units. ◦ When used with LX U5.0-30, the battery system supports a maximum working current of 720A, working power of 36kW, maximum connection of 6 inverters, and 6 battery units. • BCB-32-WW-0: <ul style="list-style-type: none"> ◦ When used with LX A5.0-30, the battery system supports a maximum working current of 720A, working power of 36kW, maximum connection of 6 inverters, and 15 battery units. ◦ When used with LX U5.0-30, the battery

Device Type	model	Description
		<p>system supports a maximum working current of 720A, working power of 36kW, maximum connection of 6 inverters, and 8 battery units.</p> <ul style="list-style-type: none"> ◦ When used with GW14.3-BAT-LV-G10, the battery system supports a maximum working current of 720A, working power of 36kW, maximum connection of 6 inverters, and 30 battery units. ◦ When used with GW16.1-BAT-LV-G10, the battery system supports a maximum working current of 720A, working power of 36kW, maximum connection of 6 inverters, and 30 battery units. • BCB-33-WW-0: <ul style="list-style-type: none"> ◦ When used with LX U5.0-30, the battery system supports a maximum working current of 720A, working power of 36kW, maximum connection of 6 inverters, and 15 battery units. When the number of battery units exceeds 8, two fuses with a rating of 600A need to be connected in parallel. • Others: Configure according to the system power and current requirements.
Smart Meter	<ul style="list-style-type: none"> • Built-in meter (shipped with the inverter) • GM330 (purchased from GoodWe) 	<ul style="list-style-type: none"> • Built-in meter: Use the CT shipped with the inverter to connect to the inverter. <ul style="list-style-type: none"> ◦ CT ratio is 120A:40mA. ◦ If the built-in meter of the inverter is insufficient, contact the distributor to purchase a GM330 Smart Meter. • GM330: The CT can be purchased from GoodWe or separately. CT ratio requirement: nA/5A <ul style="list-style-type: none"> ◦ nA: CT primary side input current, where n ranges from 200 to 5000. ◦ 5A: CT secondary side output current.

Device Type	model	Description
Smart dongle	WiFi/LAN Kit-20	<ul style="list-style-type: none"> • Applicable for single inverter networking and parallel inverter networking scenarios. • Uses Bluetooth signal for local configuration of device parameters and viewing device operation information. Uploads system operation information to the monitoring platform via WiFi or LAN. • To use features like one-click upgrade, operation log export, and parallel operation on the inverter, ensure the WiFi/LAN Kit-20 software version is V2.5 or above.
	4G Kit-CN-G20 (China only)	<ul style="list-style-type: none"> • Applicable for single inverter networking and parallel inverter networking scenarios. • Uses Bluetooth signal for local configuration of device parameters and viewing device operation information. Uploads system operation information to the monitoring platform via 4G. • To use features like one-click upgrade, operation log export, and parallel operation on the inverter, ensure the 4G Kit-CN-G20 version is version 08 or above.
	4G Kit-G20	<ul style="list-style-type: none"> • Applicable for single inverter networking scenarios. • Uses Bluetooth signal for local configuration of device parameters and viewing device operation information. Uploads system operation information to the monitoring platform via 4G.

Device Type	model	Description
grid-tied PV inverter	-	<ul style="list-style-type: none"> • GoodWe brand grid-tied inverters are recommended; third-party grid-tied inverters are also supported. • In coupling scenarios, ensure the rated output power of the grid-tied inverter \leq the rated output power of the hybrid inverter. • When the coupling system is in grid-tied mode, if power limitation is required, ensure: <ul style="list-style-type: none"> ◦ The Hybrid Inverter must be configured in the App's Export power limit interface; configure the grid-tied inverter according to the actual tool used. <p>Note: Different grid-tied inverters have different output power control accuracy. Set the export power limit parameter value according to the actual situation.</p>
Large loads	-	<p>SG Ready heat pump connection is only supported in single-unit scenarios, controlled via dry contact signal.</p> <ol style="list-style-type: none"> 1. Total power of large loads < GEN port maximum output power. 2. Large load power + BACK-UP power < AC maximum input power (Utility grid).
Generator	-	Generator power must be greater than the total power of all loads on the BACKUP port.

2.2 Product Overview

2.2.1 Inverter

The Inverter in a photovoltaic system controls and optimizes the energy flow through an integrated energy management system. It can supply the electricity generated in the photovoltaic system to loads, store it in batteries, or output it to the grid, etc.

NOTICE

Inverters of different power ranges may vary in appearance; please refer to the actual product.

No.	model	Nominal output power	Nominal output voltage
1	GW5K-ET-L-G10	5kW	400/380, 3L/N/PE
2	GW6K-ET-L-G10	6kW	400/380, 3L/N/PE
3	GW8K-ET-L-G10	8kW	400/380, 3L/N/PE
4	GW10K-ET-L-G10	10kW	400/380, 3L/N/PE
5	GW12K-ET-L-G10	12kW	400/380, 3L/N/PE
6	GW15K-ET-L-G10	15kW	400/380, 3L/N/PE
7	GW20K-ET-L-G10	20kW	400/380, 3L/N/PE
8	GW12K-ET-LL-G10	12kW	220, 3L/N/PE

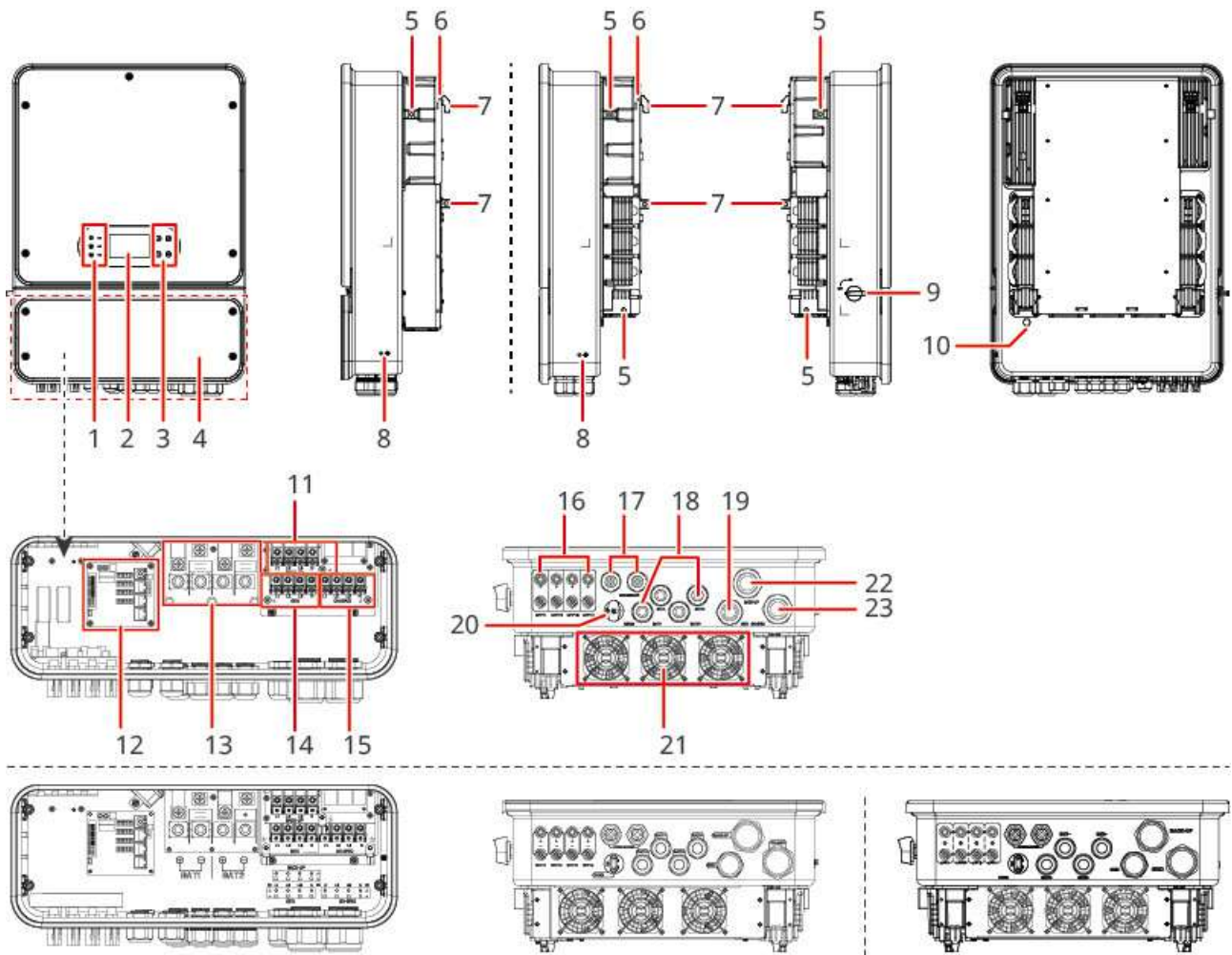

ETL10DSC0002

Component Introduction

No.	Component/Silkscreen	Description
1	indicator	Indicates the working status of the inverter.
2	Display Screen	View inverter-related data.
3	Buttons	Used in conjunction with the display screen to configure the inverter.
4	Inverter Lower Cover	-

No.	Component/Silkscreen	Description
5	Inverter Carrying Handle Mounting Hole	(Optional) Used for installing the carrying handle. <ul style="list-style-type: none"> GW5K-ET-L-G10, GW6K-ET-L-G10, GW8K-ET-L-G10, GW10K-ET-L-G10, GW12K-ET-L-G10, GW12K-ET-LL-G10 x 3 GW15K-ET-L-G10, GW20K-ET-L-G10 x 4
6	Anti-Theft Lock Mounting Hole	(Optional) Used for installing the anti-theft lock between the bracket and the inverter.
7	Inverter Wall-Mount Slot	Used for mounting the inverter when wall-mounted.
8	Grounding terminal	Connecting the PE cable.
9	DC Switch	Controls the connection or disconnection of the DC input.
10	Pressure Relief Valve	-
11, 22	BACK-UP Port	Connect AC cables to connect critical loads to the inverter.
12, 17	Communication Port	Can connect communication cables for load control, CT, RS485, Remote Shutdown/Rapid Shutdown, DRED (Australia)/RCR (Europe), etc.
13, 18	Battery Input Port	Can connect battery DC input cables. <ul style="list-style-type: none"> GW5K-ET-L-G10, GW6K-ET-L-G10, GW8K-ET-L-G10, GW10K-ET-L-G10, GW12K-ET-L-G10, GW12K-ET-LL-G10 x 1 GW15K-ET-L-G10, GW20K-ET-L-G10 x 2
14, 19	GEN Port	Used to connect a generator, large loads, or a grid-tied inverter.
15, 23	GRID Port	Connect AC cables to connect the inverter to the grid.

No.	Component/Silkscreen	Description
16	PV Input Terminal	<p>Can connect PV module DC input cables.</p> <ul style="list-style-type: none"> • GW5K-ET-L-G10, GW6K-ET-L-G10, GW8K-ET-L-G10 x 2 • GW10K-ET-L-G10, GW12K-ET-L-G10, GW12K-ET-LL-G10 x 3 • GW15K-ET-L-G10, GW20K-ET-L-G10 x 4
20	smart dongle Port	<ul style="list-style-type: none"> • Can connect communication modules, such as WiFi/LAN dongles. • Supports connecting a USB flash drive for local inverter software upgrade. • For the Brazilian market, can connect a USB-RS485 adapter cable.
21	Cooling Fan	Used for inverter heat dissipation.

Dimension Introduction

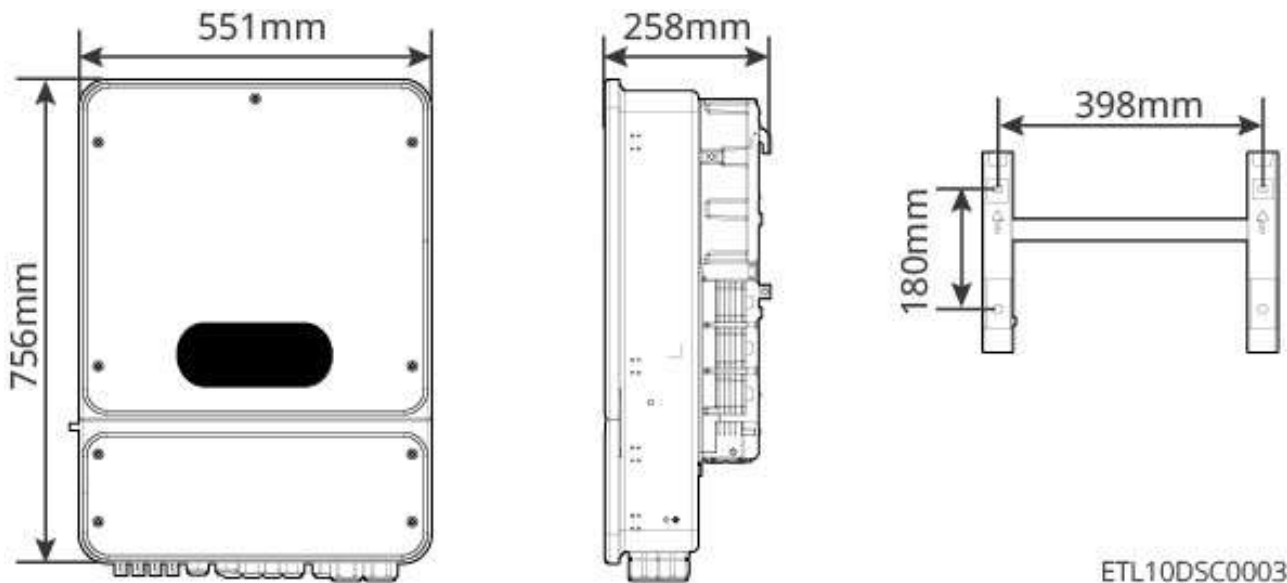

2.2.2 Battery

The Battery system can store and release electricity according to the requirements of the photovoltaic energy storage system. The input and output ports of this energy storage system are high-voltage direct current. The inverter supports use with lead-acid Battery. For related product information on lead-acid Battery, please obtain it

from the lead-acid Battery manufacturer.

2.2.2.1 LX A5.0-30

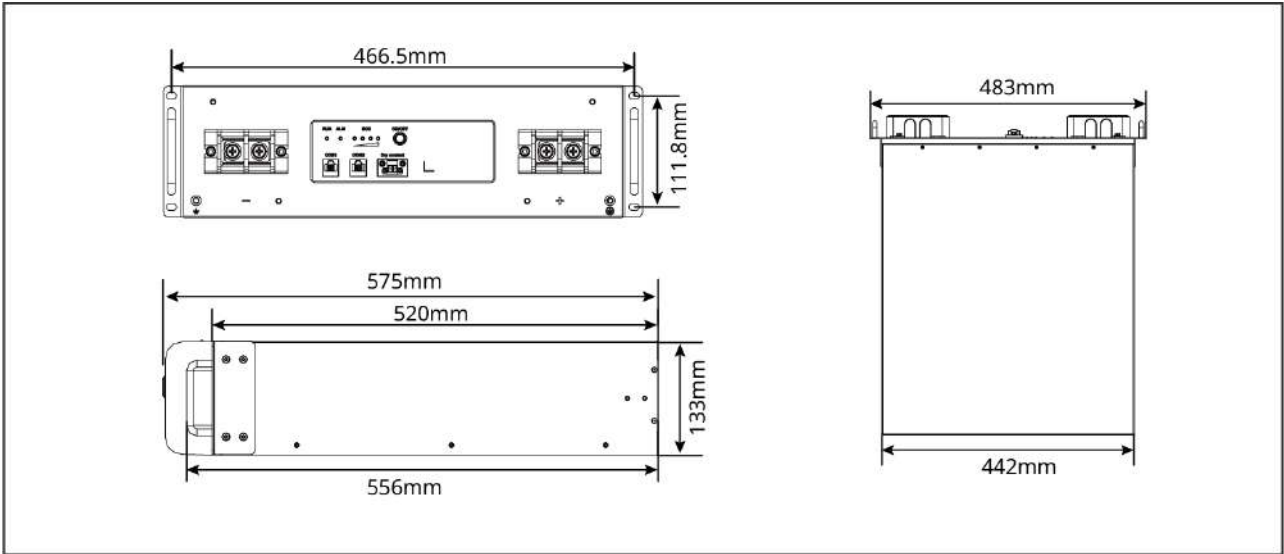

LXA30DSC0001

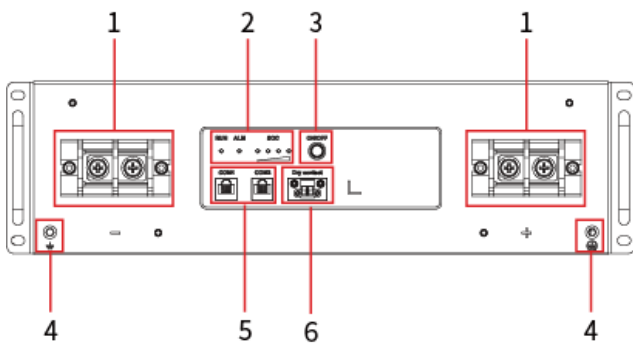

LXA30DSC0002

No.	Component/Silk Screen	Description
1	Battery DC Port	Connect the battery DC input cable.
2	indicator	Indicates the battery's operating status.
3	Battery System Button	Used for battery power on/off and black start.
4	Grounding terminal	Connect the chassis protective ground wire.
5	Communication Port	Connect the battery communication cable.

No.	Component/Silk Screen	Description
6	Dry Contact	Reserved.

2.2.2.2 GW14.3-BAT-LV-G10

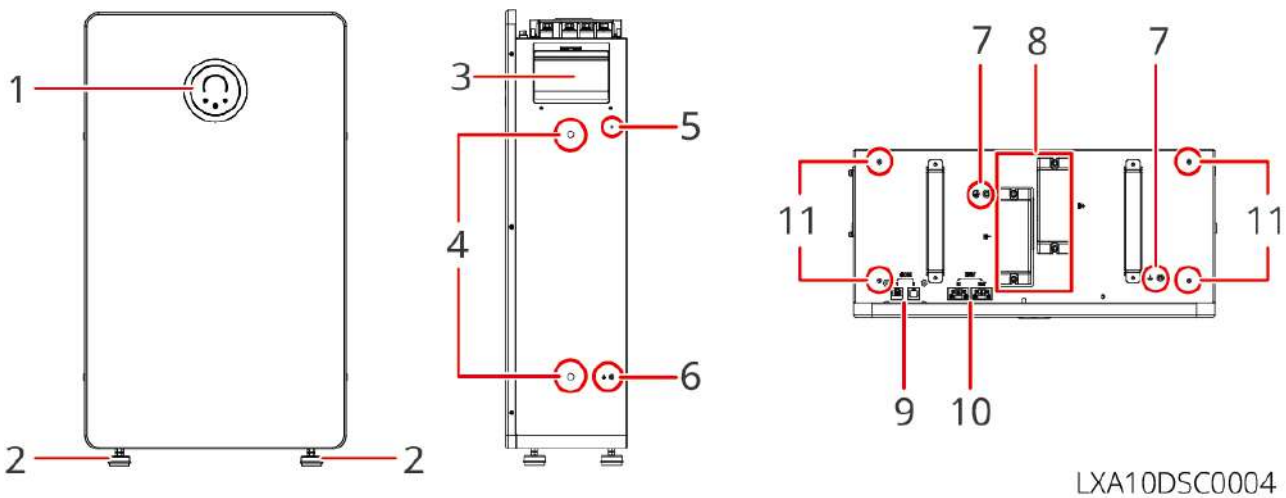
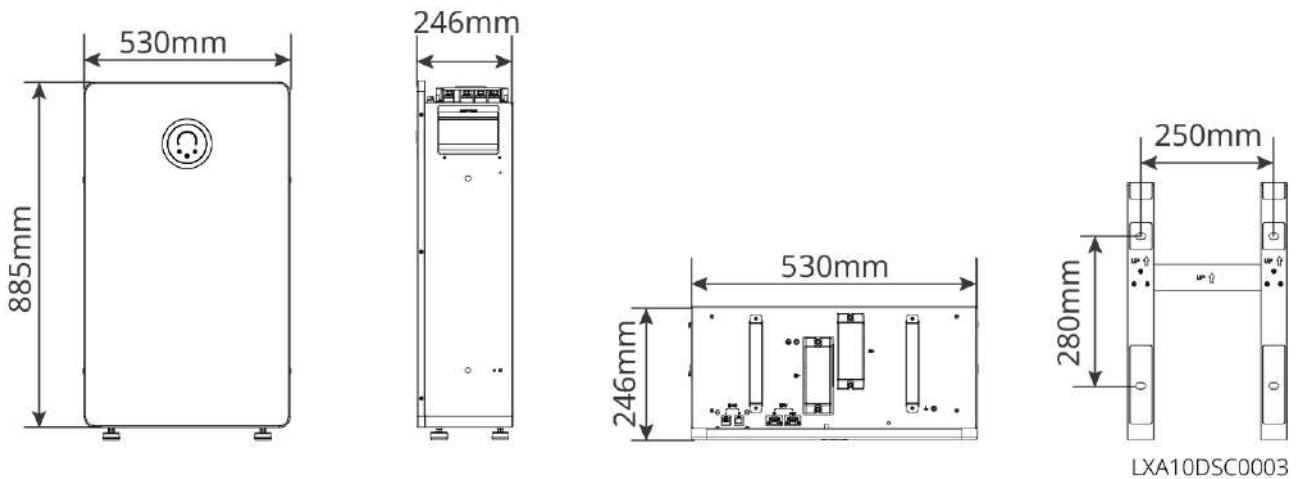

No.	Component/Silk screen	Description
1	indicator	Indicates the operating status of the battery.
2	Foot	Supports the battery.
3	Battery circuit breaker	Used for powering the battery on/off.
4	Carrying bar mounting hole	Used for installing the carrying bar. Used during manual battery handling.

No.	Component/Silk screen	Description
5	L-bracket fixing hole	Used for securing the battery to the wall.
6	Grounding terminal	Connects to the enclosure protective earth wire, reserved.
7	Grounding terminal	Connects to the battery system protective earth wire.
8	Battery DC port	Connects to the battery DC input cable.
9	Communication Port	Connects to the battery communication cable.
10	Dry contact	Reserved.
11	Decorative cover mounting hole	Used for securing the battery decorative cover.

2.2.2.3 LX U5.0-30

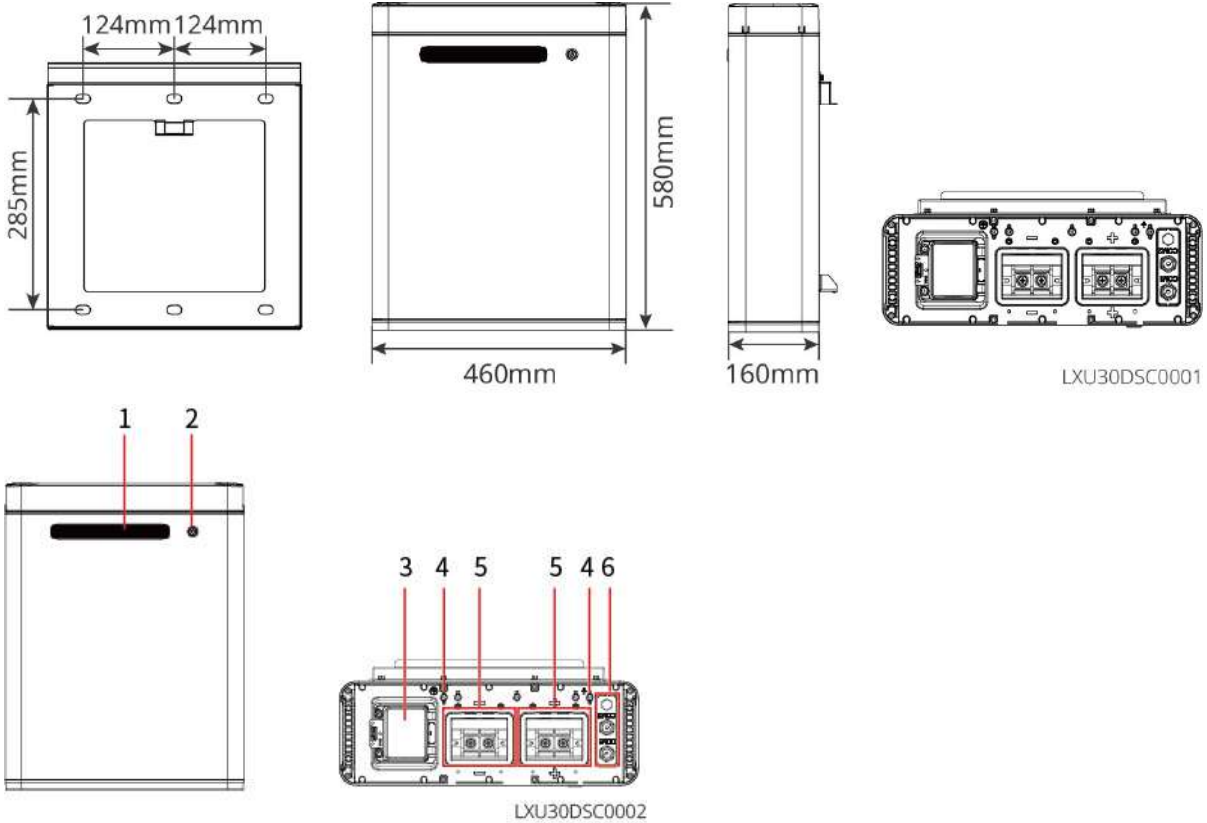

No.	Component/Silk Screen	Description
1	indicator	Indicates the working status of the battery.
2	Battery System Button	Used for battery power on/off and black start.
3	Battery Circuit Breaker	Used for battery power on/off.
4	Grounding terminal	Connect the chassis protective ground wire.
5	Battery DC Port	Connect the battery DC input cable.
6	Communication Port	Connect the battery communication cable.

2.2.2.4 GW16.1-BAT-LV-G10

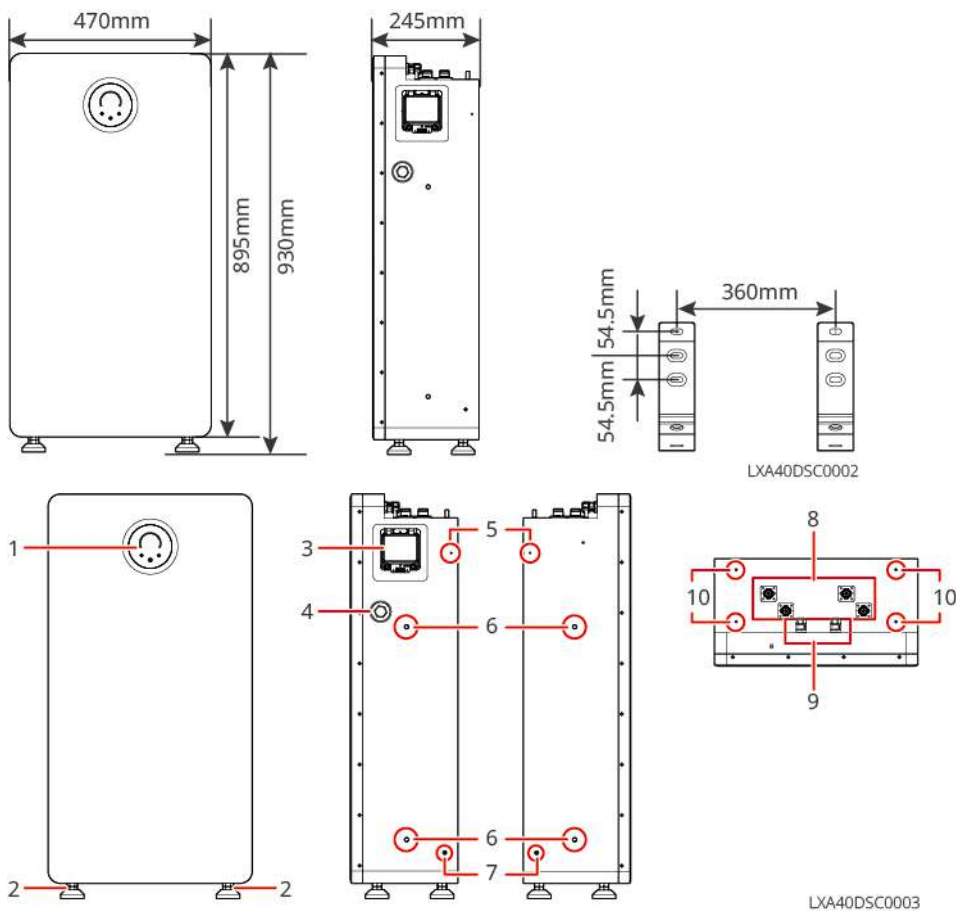

No.	Component/Silk Screen	Description
1	indicator	Indicates the battery's operating status.
2	Foot	Supports the battery.
3	Battery Circuit Breaker	Used for powering the battery on/off.
4	Explosion-proof Vent Valve	Balances internal/external air pressure and provides explosion protection.
5	Anti-tipping Bracket Mounting Hole	Used for securing the battery to the wall.
6	Lifting Bar Mounting Hole	Used for installing the lifting bar. Used during manual battery handling.
7	Grounding terminal	Connects the protective ground wire for the enclosure.
8	Battery DC Port	Connects the battery DC input cable.
9	Communication Port	Connects the battery communication cable.
10	Decorative Cover Mounting Hole	Used for securing the battery decorative cover.

2.2.3 Smart Meter

The Smart Meter measures and monitors electrical data in a photovoltaic energy storage system, such as: voltage, current, Frequency, Power Factor, power, etc.

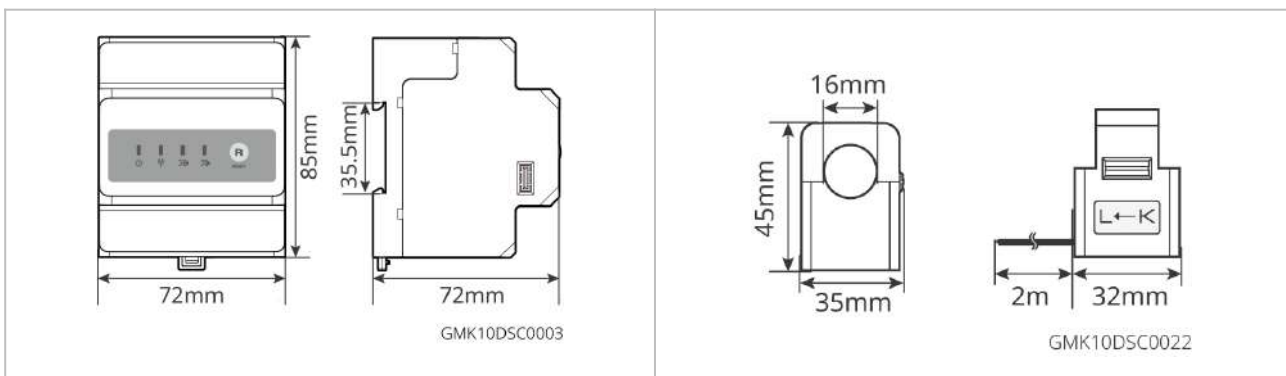

No.	model	Application Scenarios
1	GM330	<p>The CT can be purchased from GoodWe or self-sourced. CT ratio requirement: nA: 5A</p> <ul style="list-style-type: none"> • nA: CT primary side input current, where n ranges from 200 to 5000 • 5A: CT secondary side output current

2.2.4 smart dongle

The smart dongle is primarily used for real-time transmission of various inverter power generation data to a remote monitoring platform, and for connecting to the smart dongle via an App for local device debugging.

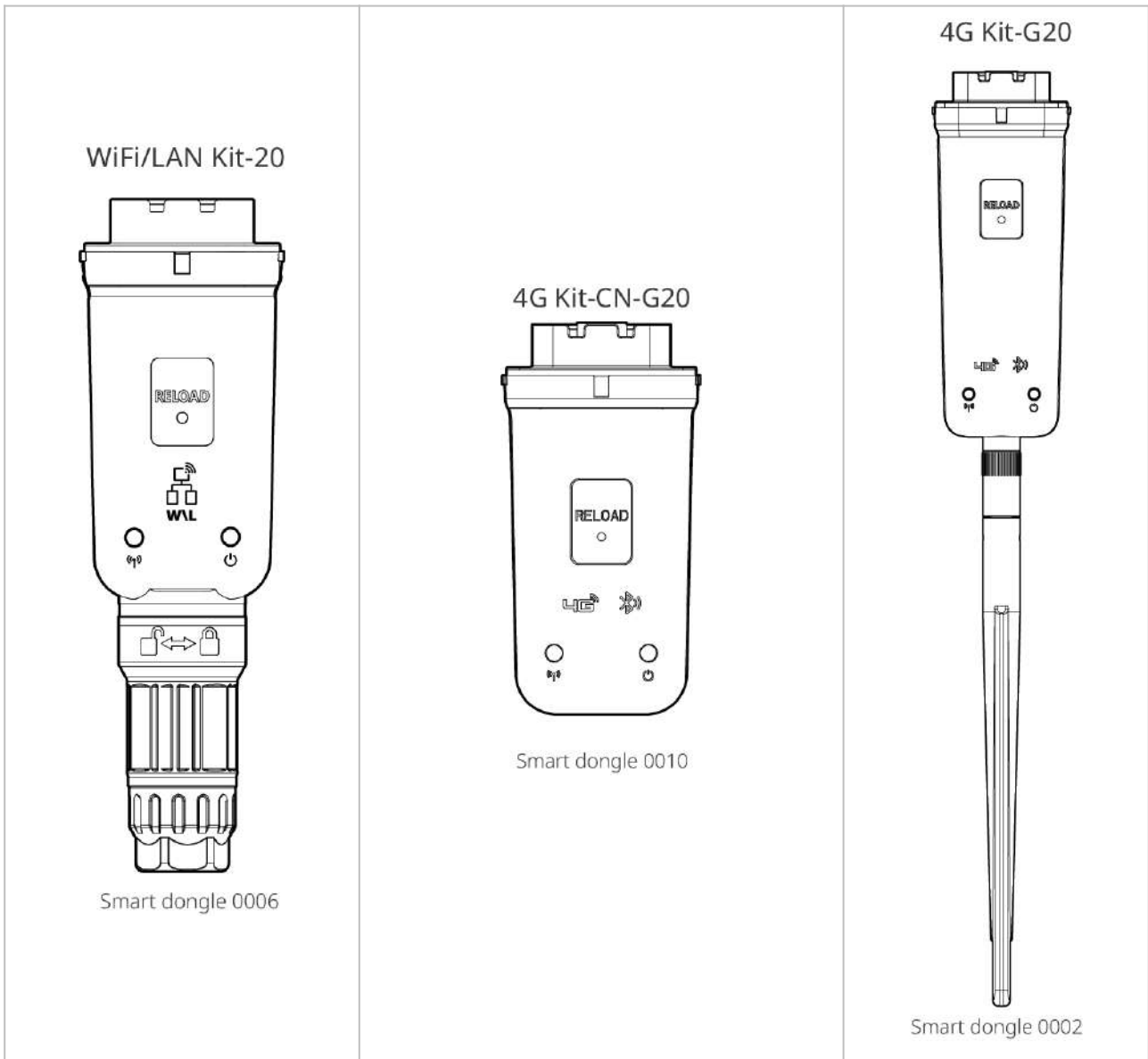

No.	model	Signal Type	Applicable Scenarios
1	WiFi/LAN Kit-20	WiFi, LAN, Bluetooth	Inverter single unit, multi-unit scenarios

No.	model	Signal Type	Applicable Scenarios
2	4G Kit-CN-G20 (China only)	4G, Bluetooth	Inverter single unit, multi-unit scenarios
3	4G Kit-G20	4G, Bluetooth	Inverter single unit scenario.

2.3 Supported Grid Types

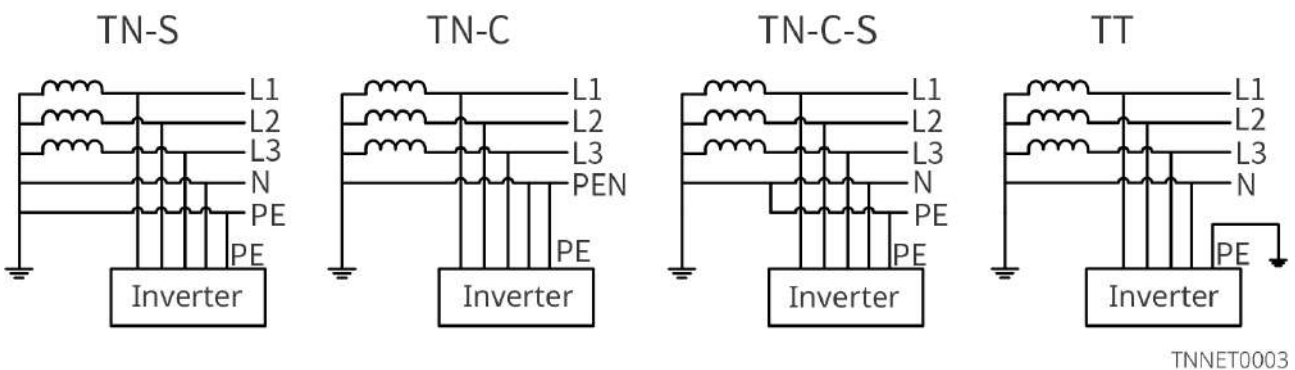

2.4 System Working Mode

NOTICE

After the first installation of the GW14.3-BAT-LV-G10 and GW16.1-BAT-LV-G10 battery systems, a full battery charge will be automatically performed once, and upon completion, it will switch to the set operating mode to run.

Self-use Mode

- The basic operating mode of the system.
- PV-generated power is prioritized for supplying loads. Excess power charges the battery, and any remaining power is sold to the grid. When PV generation cannot meet the load demand, the battery supplies the loads. When the battery's power is also insufficient to meet the load demand, the grid supplies the loads.

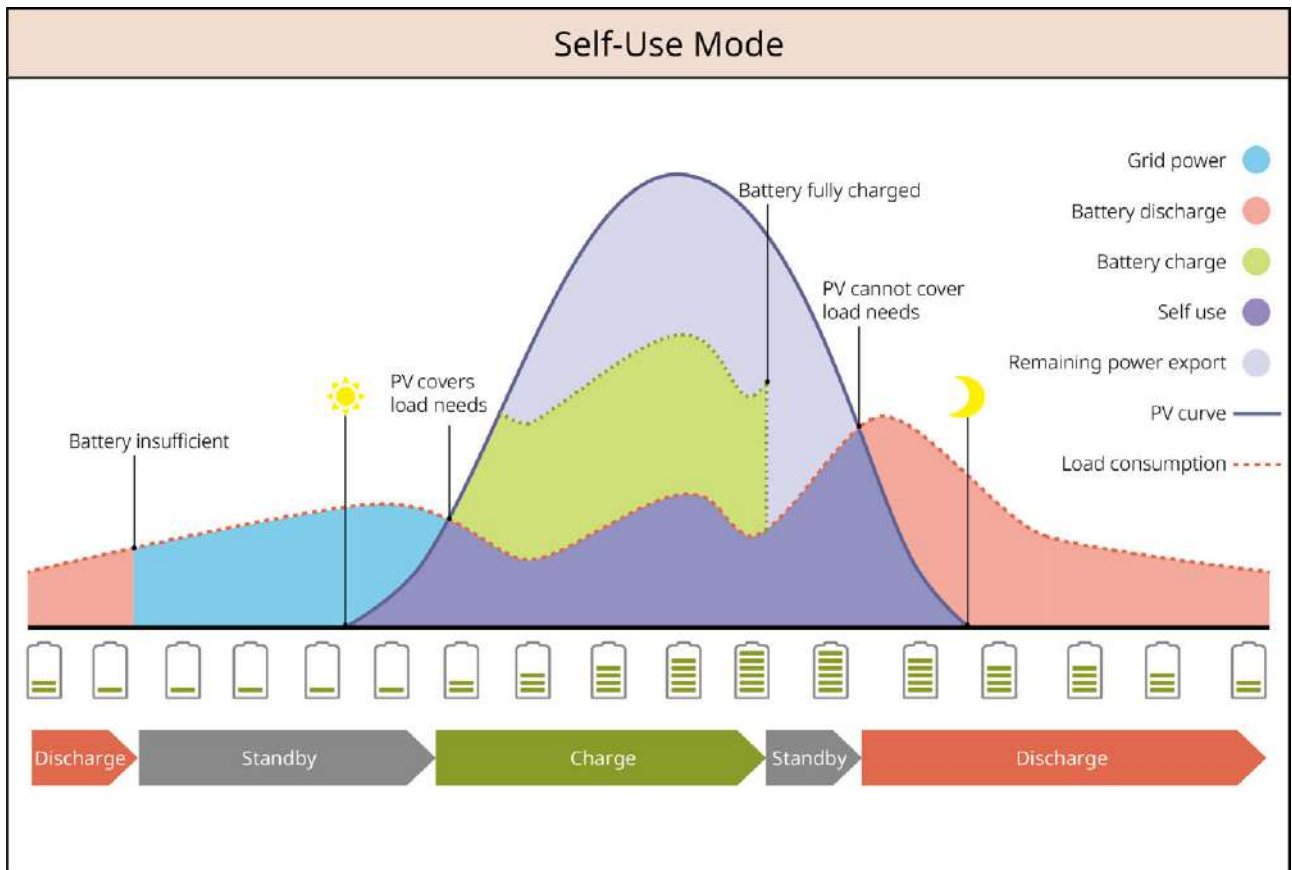

SLG00NET0009

Backup Mode

- Recommended for use in areas with unstable grid power.
- When the grid fails, the inverter switches to off-grid operation mode, and the battery discharges to power the loads, ensuring the BACK-UP Loads remain powered. When the grid is restored, the inverter switches back to grid-connected operation.
- To ensure the battery SOC is sufficient for normal system operation during off-grid periods, the system will charge the battery using PV power or by purchasing power from the grid up to the backup power SOC during grid-connected operation. If you need to purchase power from the grid to charge the battery, please ensure it complies with local grid regulations and laws.

Back-up Mode ①

Charging from grid: disabled

Back-up SOC: 60%

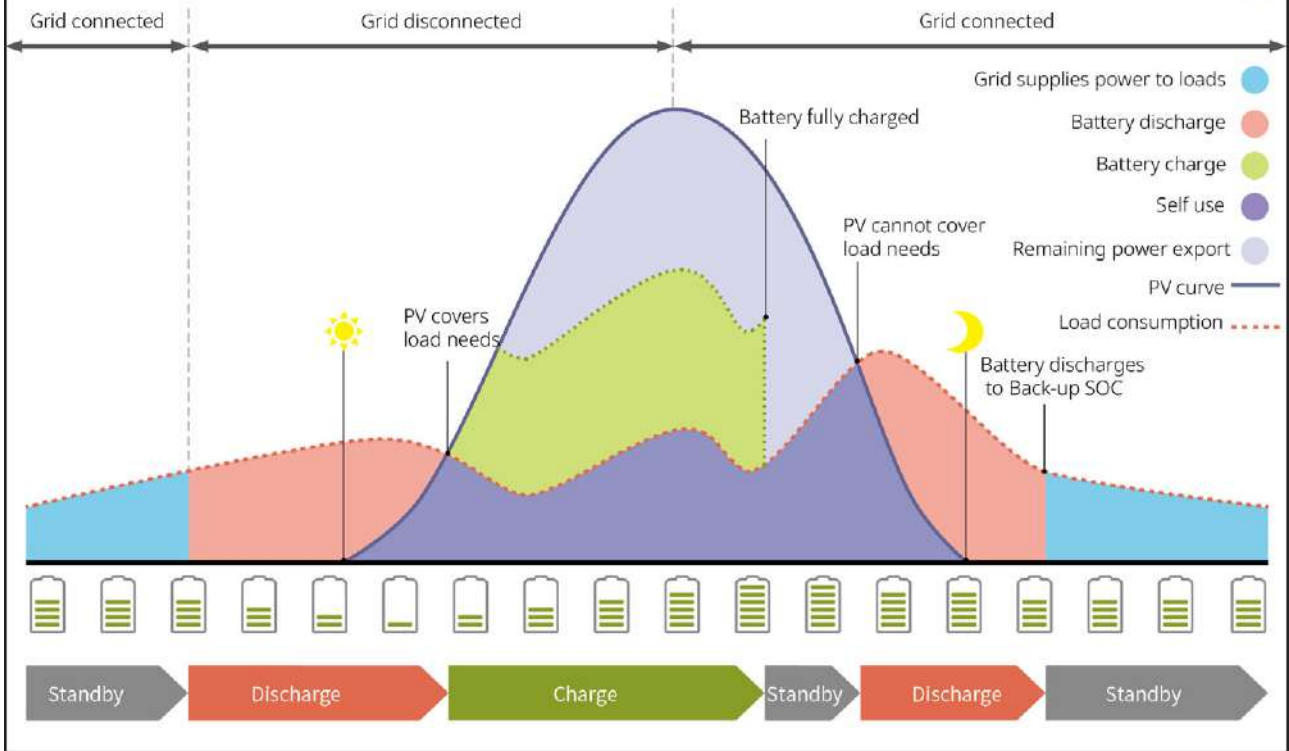

SLG00NET0002

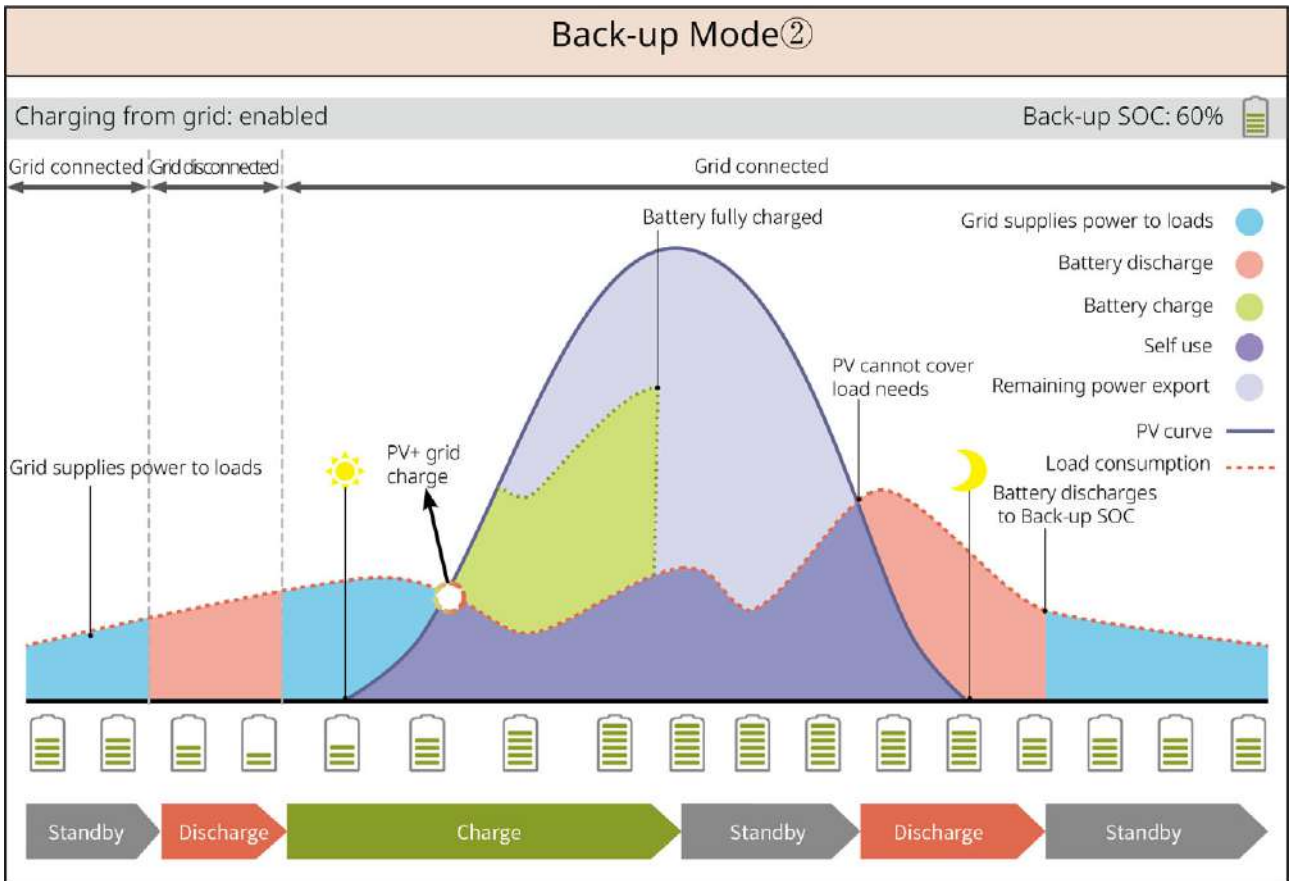

SLG00NET0003

TOU Mode

Subject to local laws and regulations, set different time periods for buying and selling electricity based on peak and off-peak grid electricity price differences.

For example: During off-peak hours, set the battery to charge mode, purchasing power from the grid for charging. During peak hours, set the battery to discharge mode, supplying loads via the battery.

TOU Mode①

PV: Charge battery in priority

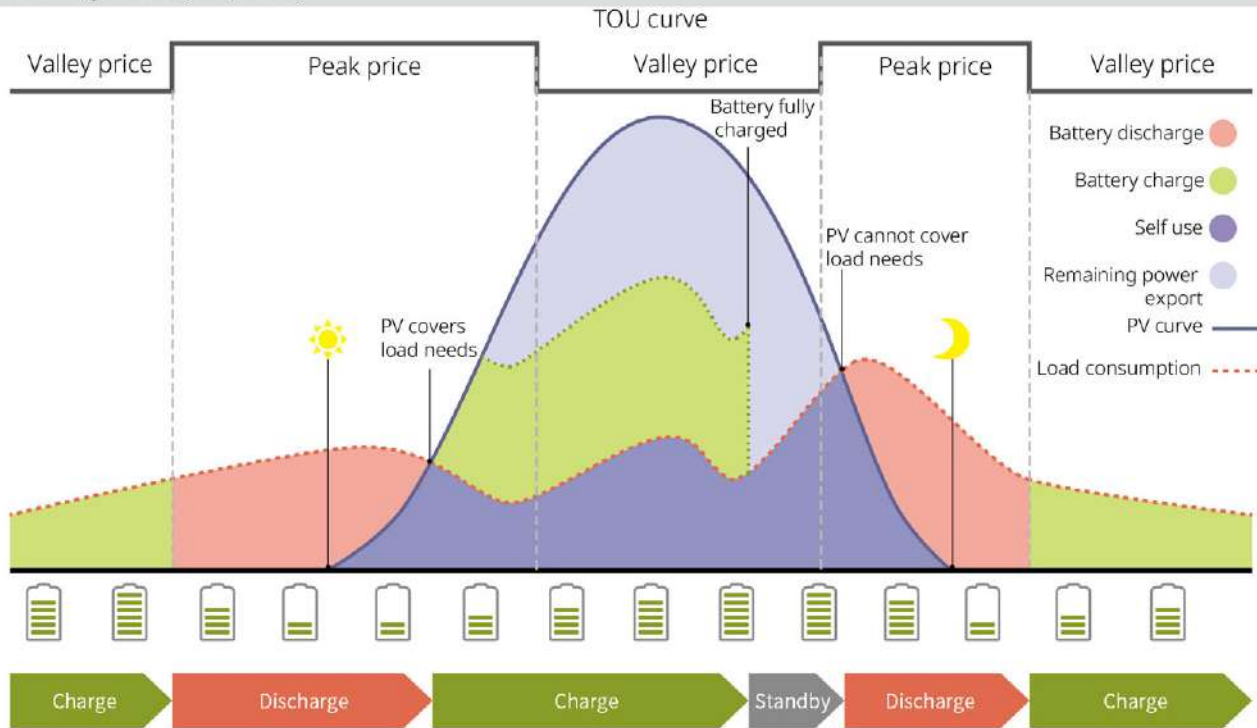

SLG00NET0004

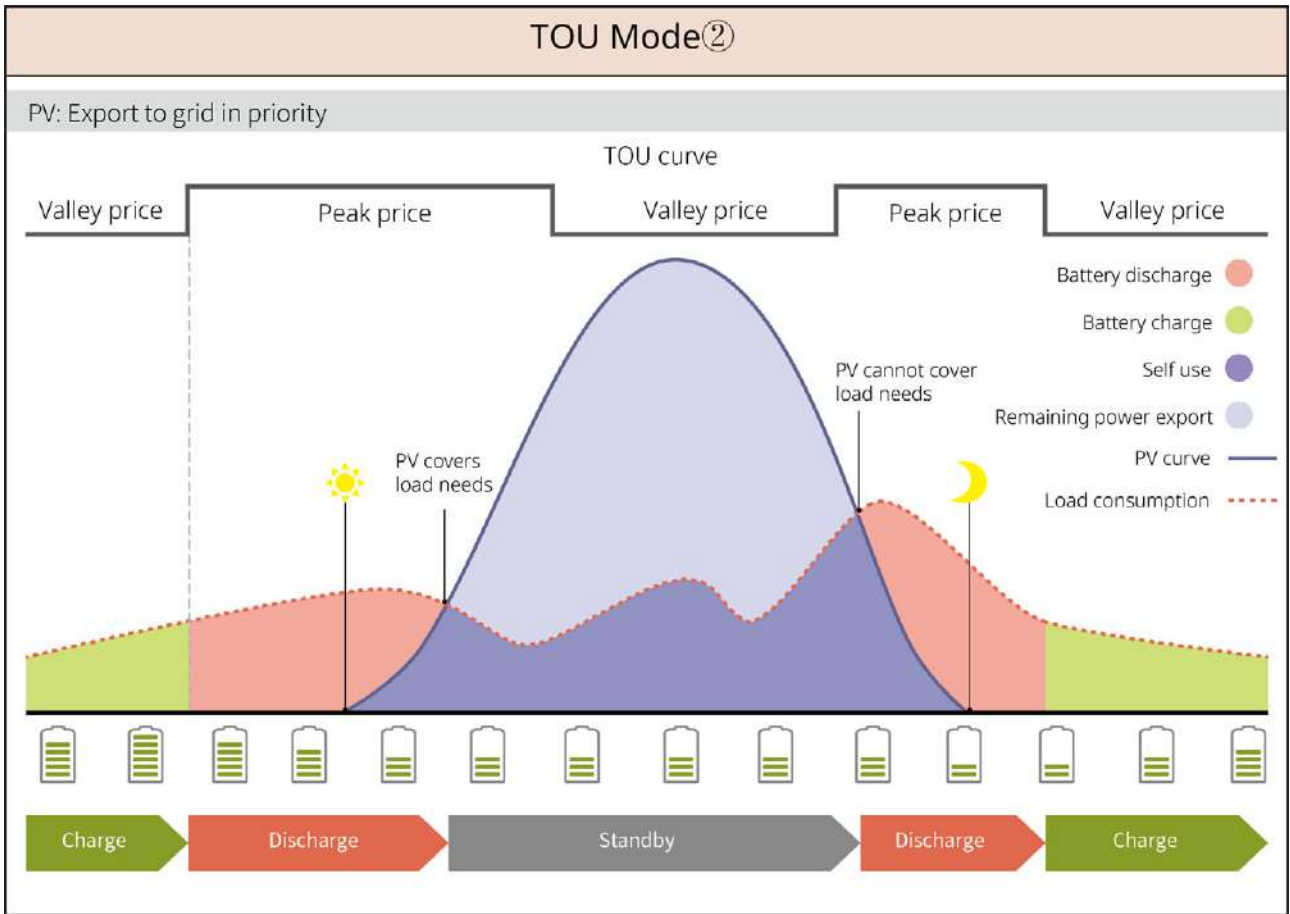

SLG00NET0005

Delayed Charging Mode

- Suitable for areas with grid-connected power output limitations.
- Setting a peak power limit can direct excess PV generation beyond the grid limit to charge the battery. Alternatively, setting a PV charging period allows using PV generation to charge the battery during that time.

Smart Charging ①

PV > Peak Limit

Switch to Charge: enabled/disabled

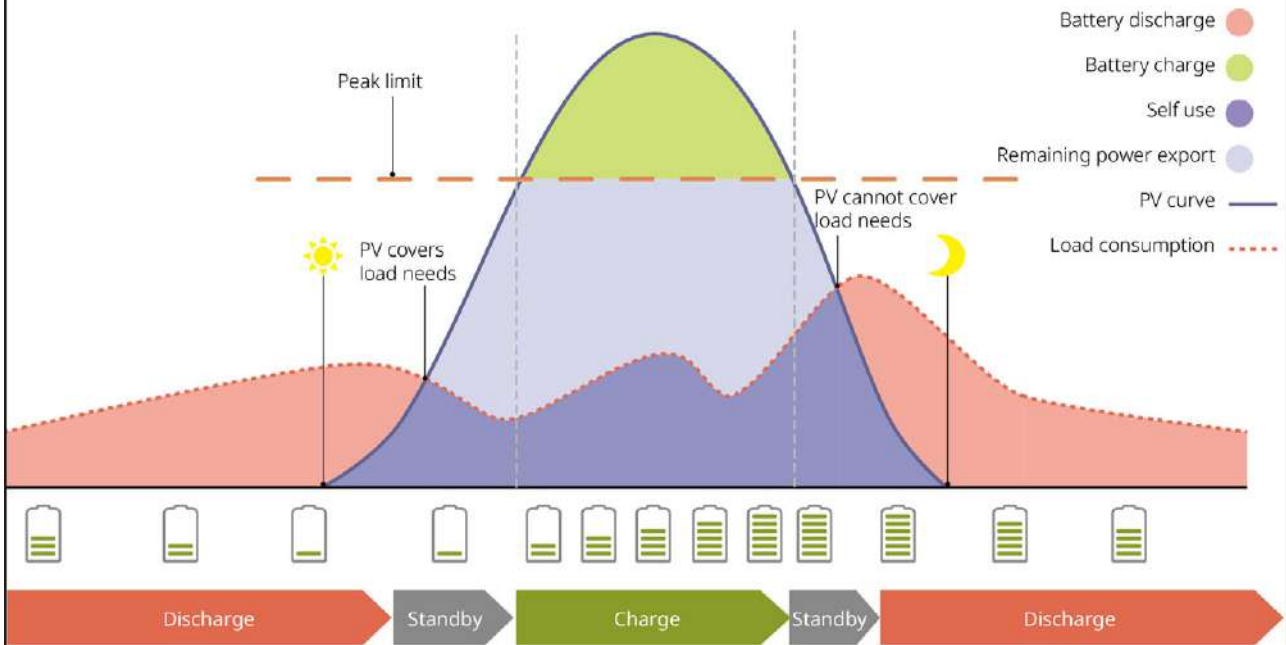

SLG00NET0006

Smart Charging ②

PV < Peak Limit

Switch to Charge: enabled

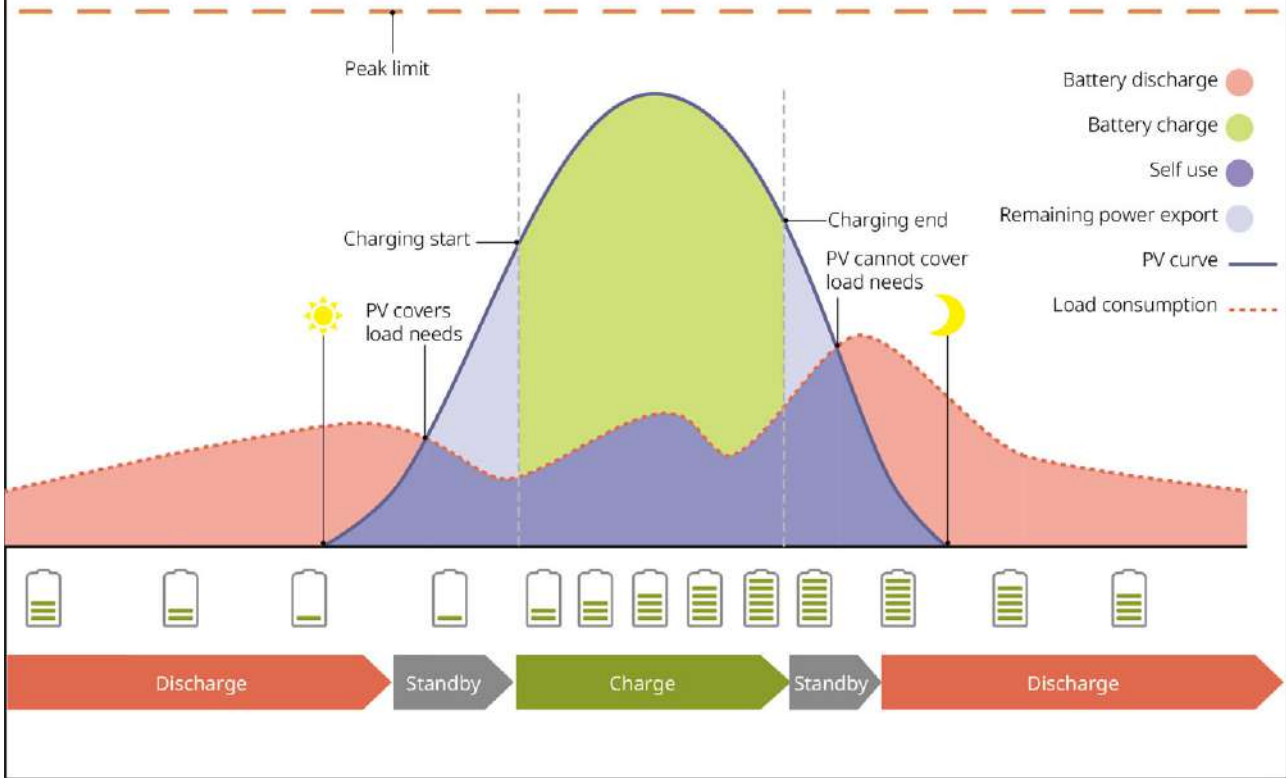

SLG00NET0007

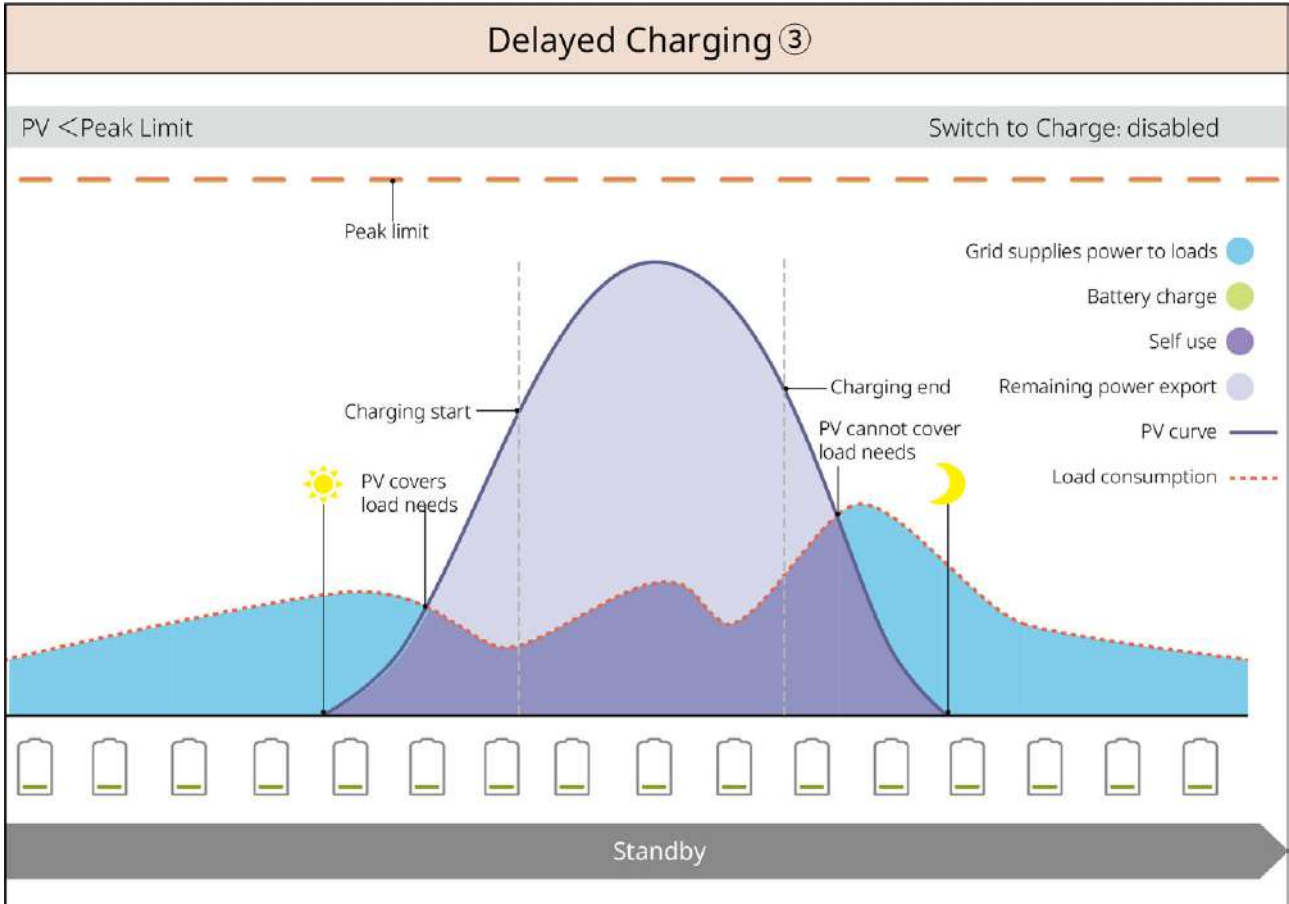

Demand Control Mode

- Primarily suitable for commercial and industrial scenarios.
- When the total load power consumption exceeds the electricity quota within a short period, battery discharge can be utilized to reduce the portion of consumption exceeding the quota.
- When the SOC of both inverter battery strings is lower than the reserved SOC for Demand Control, the system purchases power from the grid based on time periods, load consumption, and the peak power purchase limit. When only one inverter battery string's SOC is lower than the reserved SOC for Demand Control, the system purchases power from the grid based on load consumption and the peak power purchase limit.

Peakshaving ①

BAT1/BAT2 SOC < 80

Reserved SOC For Peakshaving: 80 

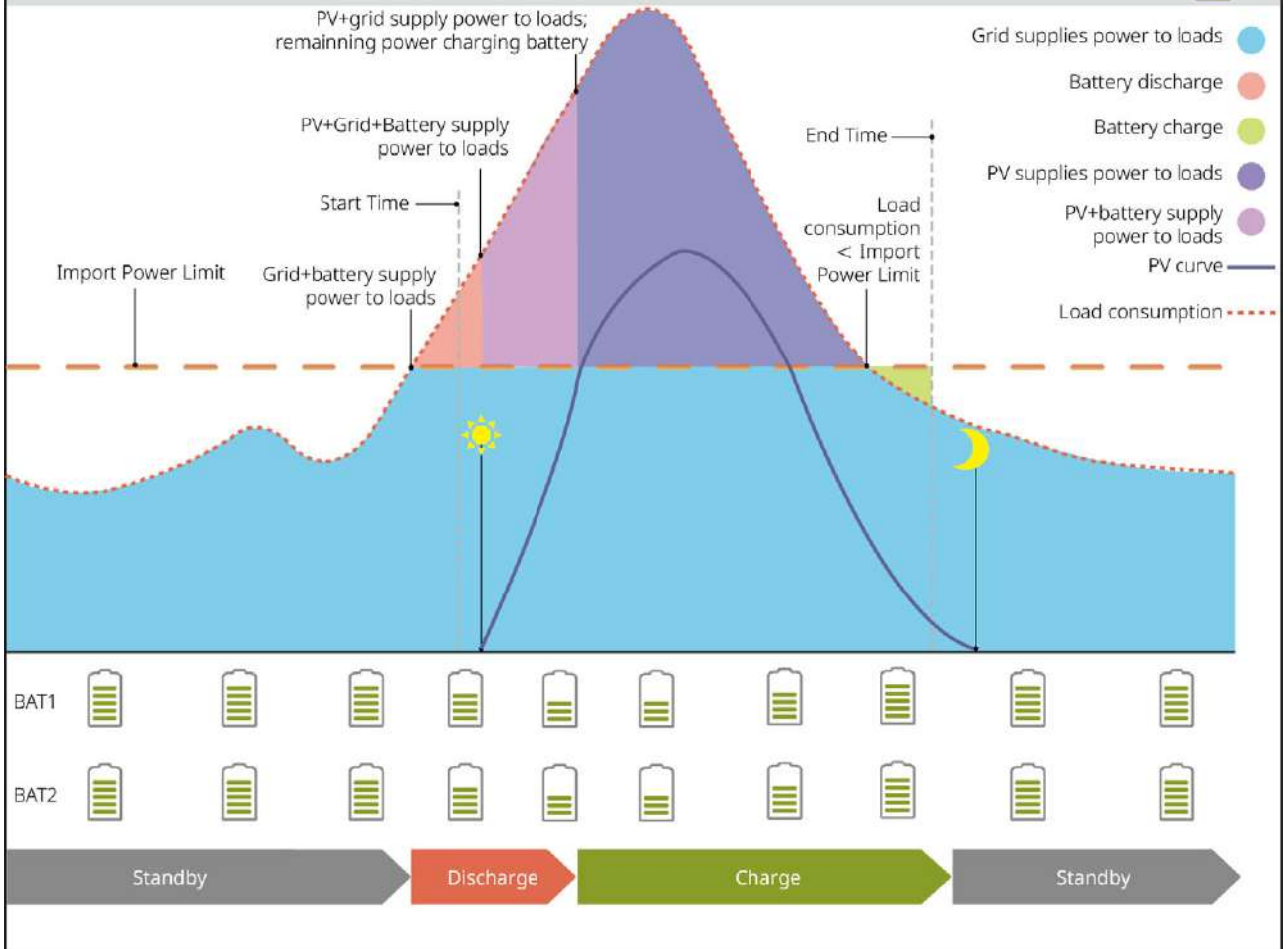

SLG00NET001C

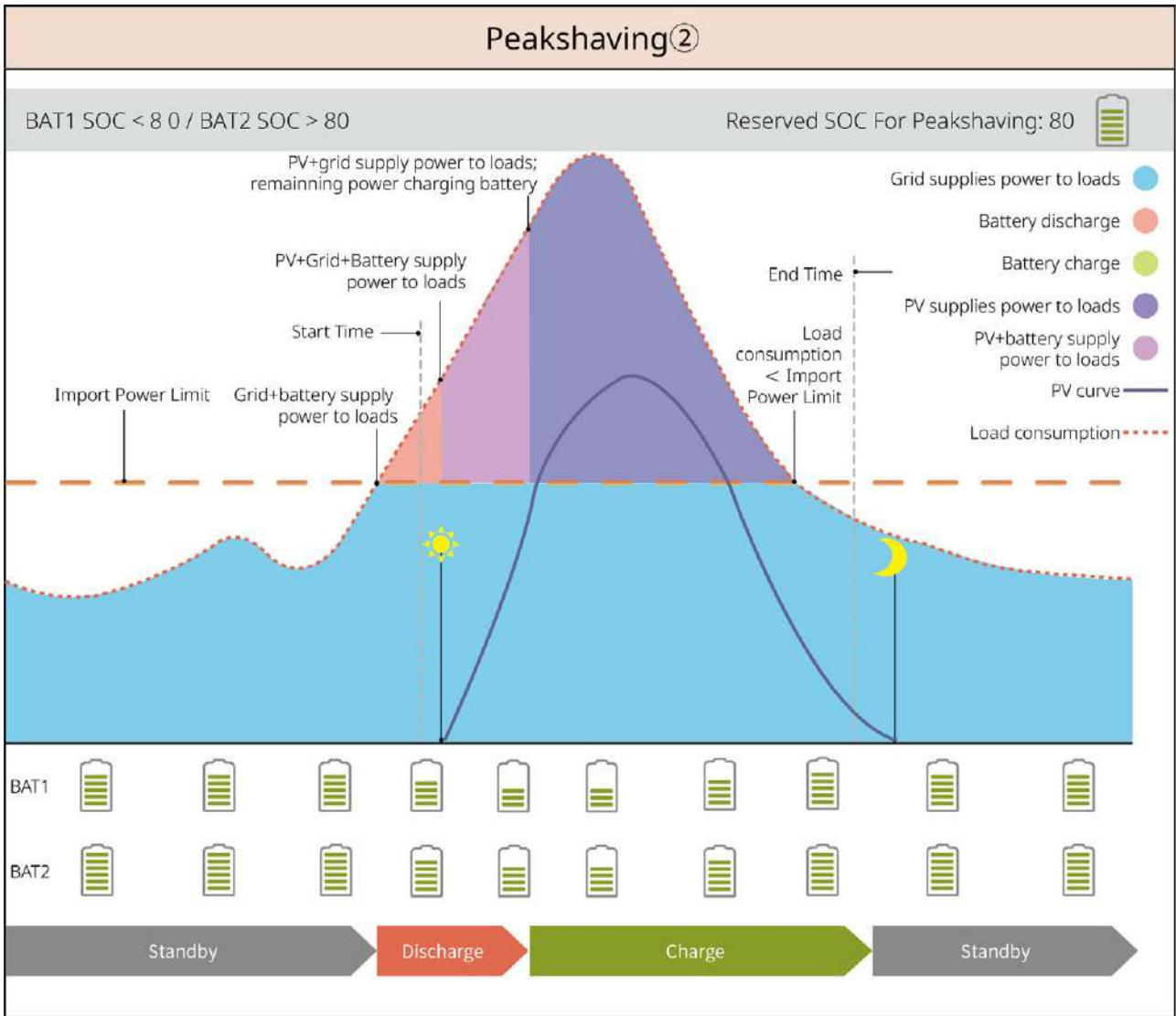

Off-grid Mode

NOTICE

Do not operate in pure off-grid mode when the inverter is not connected to a battery system.

When the grid fails, the inverter switches to off-grid operation mode.

- During the day, PV-generated power is prioritized for supplying loads, with excess power charging the battery.
- At night, the battery discharges to power the loads, ensuring the BACK-UP Loads remain powered.
- Off-grid SOC Recovery: After the system operates off-grid, the battery gradually

recovers to the minimum SOC through PV generation or other generation methods.

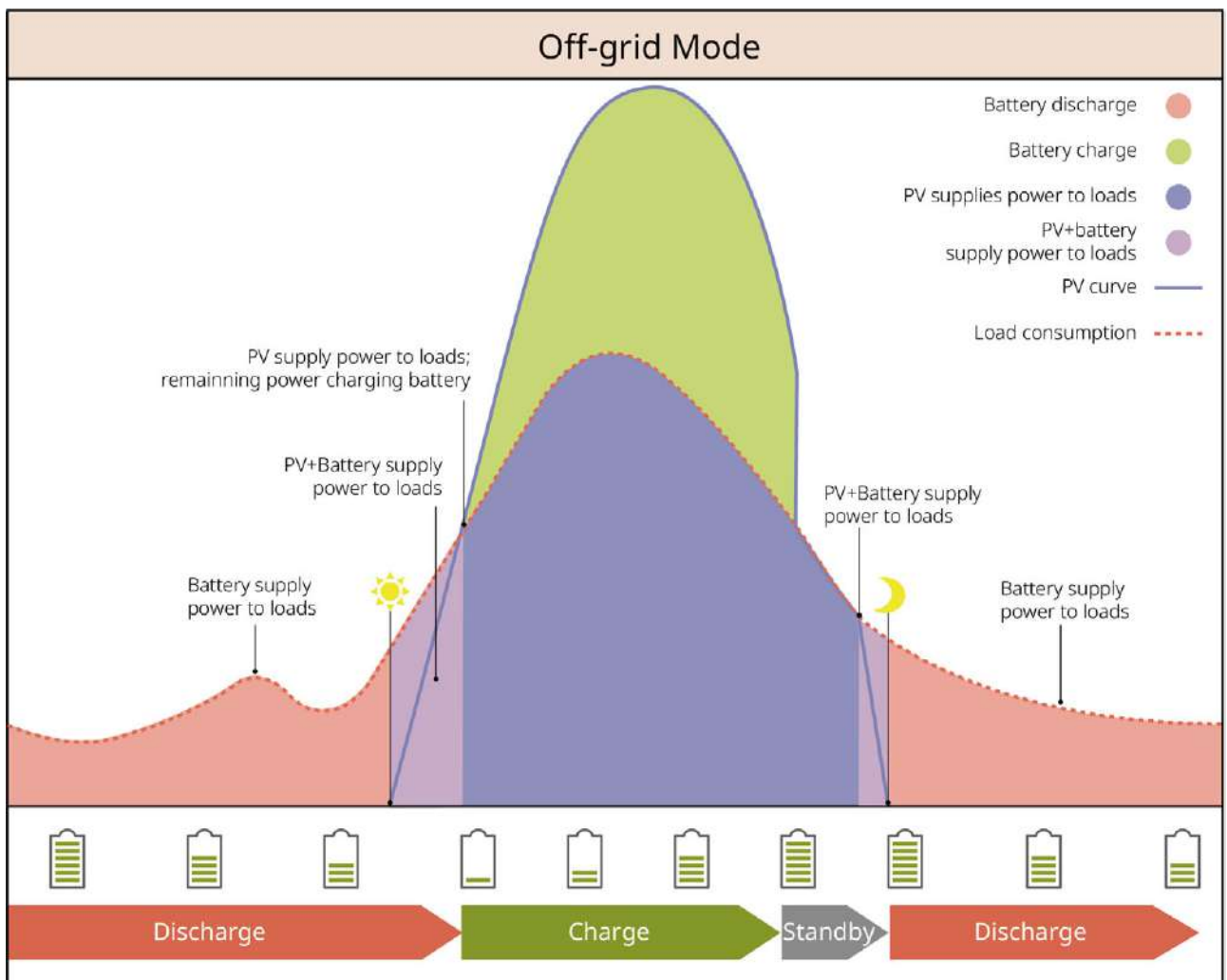

SLG00NET0012

2.5 Features

NOTICE

Please refer to the actual product configuration for specific functional features.

AFCI

The inverter integrates an AFCI circuit protection device to detect arc faults and quickly disconnect the circuit upon detection, thereby preventing electrical fires.

Causes of arc faults:

- Damage to connector connections in the PV system.
- Incorrect or damaged cable connections.
- Aging of connectors or cables.

Fault handling methods:

1. When the inverter detects an arc fault, the fault type can be viewed via the inverter display or App.
2. If the inverter triggers the fault <5 times within 24 hours, it will automatically restore grid connection protection after a 5-minute wait. After the 5th arc fault, the fault must be cleared before the inverter can resume normal operation. For specific operations, please refer to the App user manual.

model	Label	Description
GW5K-ET-L-G10 GW6K-ET-L-G10 GW8K-ET-L-G10	AFCI: F-I-AFPE-1-2-1	F (Full coverage): Full coverage of inverter PV input ports I (Integrated): Integrated within the inverter AFPE (arc fault protection equipment): Combines AFD and AFI two types of arc fault detection functions 1: One pair of PV input ports (PV+, PV-) connects to one string of PV input 2: The number of PV input ports detected by one arc fault detection sensor 1: The number of arc fault detection sensors

model	Label	Description
GW10K-ET-L-G10 GW12K-ET-L-G10 GW12K-ET-LL-G10	AFCI: F-I-AFPE-1-2/1-2	F (Full coverage): Full coverage of inverter PV input ports I (Integrated): Integrated within the inverter AFPE (arc fault protection equipment): Combines AFD and AFI two types of arc fault detection functions 1: One pair of PV input ports (PV+, PV-) connects to one string of PV input 2/1: The number of PV input ports detected by one arc fault detection sensor 2: The number of arc fault detection sensors
GW15K-ET-L-G10 GW20K-ET-L-G10	AFCI: F-I-AFPE-1-2-2	F (Full coverage): Full coverage of inverter PV input ports I (Integrated): Integrated within the inverter AFPE (arc fault protection equipment): Combines AFD and AFI two types of arc fault detection functions 1: One pair of PV input ports (PV+, PV-) connects to one string of PV input 2: The number of PV input ports detected by one arc fault detection sensor 2: The number of arc fault detection sensors

Three-Phase Unbalanced Output

The inverter supports three-phase unbalanced output on both the grid-tie side and the BACK-UP side, allowing loads of different power ratings to be connected to each phase. The maximum output power per phase for different models is shown in the following table:

No.	model	Single-Phase Maximum Output Power
1	GW5K-ET-L-G10	4kW
2	GW6K-ET-L-G10	4kW
3	GW8K-ET-L-G10	4kW
4	GW10K-ET-L-G10	6kW
5	GW12K-ET-L-G10	6kW
6	GW15K-ET-L-G10	10kW
7	GW20K-ET-L-G10	10kW
8	GW12K-ET-LL-G10	6kW

load control

The inverter's dry contact control port supports connection to an additional contactor for controlling load turn-on or turn-off. Suitable for household loads, heat pumps, etc.

Load control methods are as follows:

- Time Control: Set the time for turning the controlled load on or off. The load will automatically turn on or off within the set time period.
- Switch Control: When the control mode is set to ON, the load will turn on; when set to OFF, the load will turn off.
- BACK-UP Loads Control: The inverter has a built-in relay dry contact control port. Loads can be turned off via the relay. In off-grid mode, if an overload on the BACK-UP side is detected and the battery SOC value is below the off-grid protection setting, the loads connected to the relay port can be turned off.

Rapid Shutdown (RSD)

In a rapid shutdown system, the rapid shutdown transmitter and receiver work together to achieve system rapid shutdown. The receiver maintains module output by receiving signals from the transmitter. The transmitter can be external or built into the inverter. In an emergency, by enabling an external trigger device, the transmitter can be deactivated, thereby shutting down the modules.

- External Transmitter

- Transmitter Models: GTP-F2L-20, GTP-F2M-20
<https://en.goodwe.com/Ftp/Installation-instructions/RSD2.0-transmitter.pdf>
- Receiver Models: GR-B1F-20, GR-B2F-20
https://en.goodwe.com/Ftp/EN/Downloads/User%20Manual/GW_RSD-20_Quick-Installation-Guide-POLY.pdf
- Built-in Transmitter
 - External Trigger Device: External switch
 - Receiver Models: GR-B1F-20, GR-B2F-20
https://en.goodwe.com/Ftp/EN/Downloads/User%20Manual/GW_RSD-20_Quick-Installation-Guide-POLY.pdf

3 Check and Storage

3.1 Check Before Receiving

Before signing for the product, please carefully check the following:



1. Check the outer packaging for any damage, such as deformation, holes, cracks, or any other signs that could indicate damage to the equipment inside the box. If damage is found, do not open the packaging and contact your distributor.
2. When removing the GW14.3-BAT-LV-G10 and GW16.1-BAT-LV-G10 batteries, please ensure the cardboard packaging box remains intact. If the packaging is accidentally damaged and you need to process a return or exchange due to product quality issues, please contact GoodWe after-sales service or your distributor to obtain a dedicated packaging box.
3. Check if the device model is correct. If it does not match, do not open the packaging and contact your distributor.





3.2 deliverables



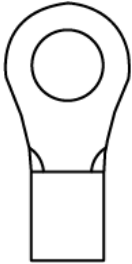
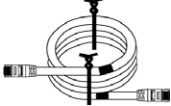
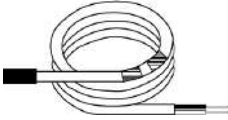

⚠ WARNING

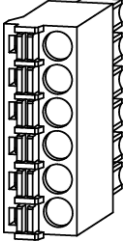
Check if the type and quantity of the delivered items are correct, and if there is any damage to the appearance. If damaged, please contact your dealer.
After removing the delivered items from the packaging, do not place them on rough, uneven, or sharp surfaces to avoid paint chipping.

3.2.1 Inverter Deliverables

Part	Description	Part	Description
	Inverter x1		mounting plate x1

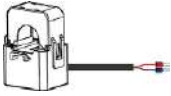
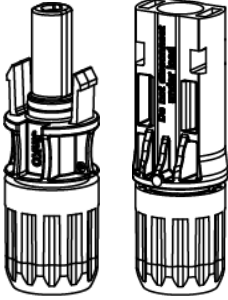
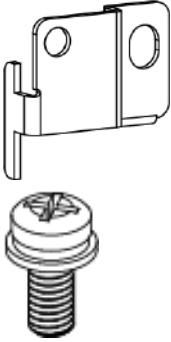

Part	Description	Part	Description
	Expansion screw x4		Grounding terminal x4
	BMS network cable <ul style="list-style-type: none"> • GW5K-ET-L-G10, GW6K-ET-L-G10, GW8K-ET-L-G10, GW10K-ET-L-G10, GW12K-ET-L-G10, GW12K-ET-LL-G10 x 1 • GW15K-ET-L-G10, GW20K-ET-L-G10 x 2 		Lead-acid battery temperature sensor cable x N N: China region x 0; other regions x 1.
	Lead-acid battery temperature sensor cable fixing adhesive tape x N N: China region x 0; other regions x 2.		Battery power line tubular terminal <ul style="list-style-type: none"> • GW5K-ET-L-G10, GW6K-ET-L-G10, GW8K-ET-L-G10, GW10K-ET-L-G10, GW12K-ET-L-G10, GW12K-ET-LL-G10 x 2 • GW15K-ET-L-G10, GW20K-ET-L-G10 x 4
	6Pin communication terminal x 4		Signal line tubular terminal x 28

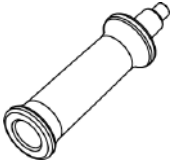
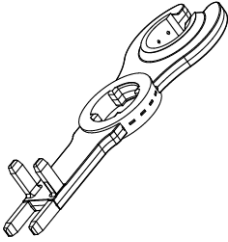
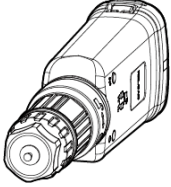
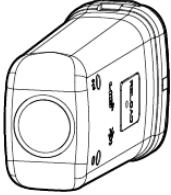
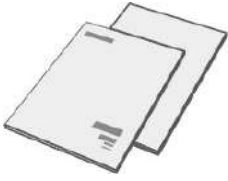







Part	Description	Part	Description
	GEN tubular terminal x 4		BACK-UP and ON-GRID tubular terminal x 8
	CT x 3		PV DC connection terminal <ul style="list-style-type: none"> • GW5K-ET-L-G10, GW6K-ET-L-G10, GW8K-ET-L-G10 x 2 • GW10K-ET-L-G10, GW12K-ET-L-G10, GW12K-ET-LL-G10 x 3 • GW15K-ET-L-G10, GW20K-ET-L-G10 x 4
	(Optional) <ul style="list-style-type: none"> • Anti-theft lock fixing sheet metal x 1 • M5 screw x 1 Note: If you need to install an anti-theft lock, please contact GoodWe to purchase the anti-theft lock fixing sheet metal.		M6 hex key x 1

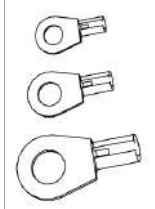

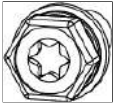
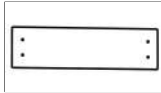

Part	Description	Part	Description
	Lifting rod x 2		PV unlocking tool x N N: China region x 0; other regions x 1.
 or 	smart dongle x1		Product documentation x 1

3.2.2 Batteries Deliverables









3.2.2.1 LX A5.0-30

Part	Description	Part	Description
	Battery Module x 1		Terminal resistor x 1 This terminal resistor must be installed on the battery when connecting to a third-party busbar.



Part	Description	Part	Description
	<ul style="list-style-type: none"> • M5 OT terminal x 2: Recommended for connecting 10mm² cable • M8 OT terminal x 4: Recommended for connecting 50mm² cable • M10 OT terminal x 2: Recommended for connecting 70mm² cable 		M5*12 Grounding screw x 2
	Mounting Bracket x 2 Included when the wall-mounted installation method is selected.		M6*70 Expansion Bolt x 4 Included when the wall-mounted installation method is selected.
	M5*12 Grounding screw x 2 Included when the wall-mounted installation method is selected.		Marking Template x 1 Included when the wall-mounted installation method is selected.
	Battery Stand x 2 (Optional) Included when the stacked installation method is selected.		M4*8 screw x 8 Included when the stacked installation method is selected.
	Product Documentation x 1		Negative Power Cable (Optional) x 1

Part	Description	Part	Description
	Positive Power Cable (Optional) x 1		Grounding Cable (Optional) x 1
	Communication cable (Optional) x 1		Decorative Cover (Optional) x 1

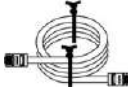



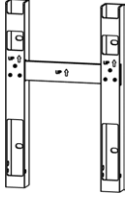
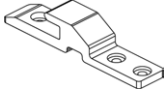
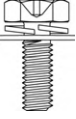





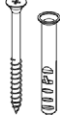

3.2.2.2 Batteries Deliverables (GW14.3-BAT-LV-G10)

Part	Description	Part	Description
	Battery x 1		Cable cover x 1
	Lifting rod x 2 (Included in shipment after October 2025)		Expansion screw x 2
	M5*16 Phillips hex head screw x 7		Wall-mounted anti-tip bracket x 2
	Terminal resistor x 1		Grounding OT terminal x 1 (Included in shipment before October 2025)
	DC OT terminal x 6 (Included in shipment before October 2025)		Grounding cable x 1 (Included in shipment after October 2025)
	Positive power cable x 1 (Included in shipment after October 2025)		Negative power cable x 1 (Included in shipment after October 2025)
	Communication cable x 1		Product documentation x 1

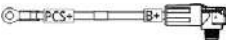

Optional Accessories

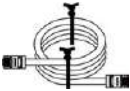

Component	Description	Component	Description
	Wall Mount Bracket x 1		Hook x 4
	M5*16 Internal Cross External Hex x 12		M10 Expansion Bolt x 4

3.2.2.3 Batteries Deliverables (GW16.1-BAT-LV-G10)

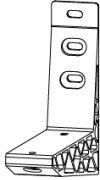
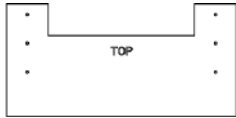
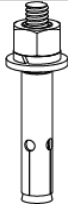



Part	Description	Part	Description
	Battery x 1		Decorative cover x 1
	Lifting rod x 2		Expansion screw x 2
	M5*12 hex socket screw x 7		Wall-mount anti-tip bracket x 2
	Terminal resistor x 1		Grounding wire x 1
	Positive power cable x 1		Decorative cover plug x 4
	Negative power cable x 1		Product documentation x 1
	Communication cable x 1		
	Quick-connect terminal release tool x 1		



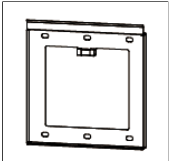

Optional accessories

Component	Description	Component	Description
	Wall mount bracket x 2		Positioning cardboard x 1
	M10 expansion bolt x 6		M10*60 bolt x 2

Component	Description	Component	Description
 	Inter-battery parallel cluster positive power cable x 1 Inter-battery parallel cluster negative power cable x 1		

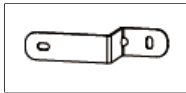
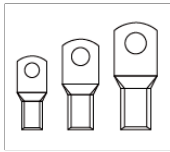
3.2.2.4 Battery Deliverables (LX U5.0-30)

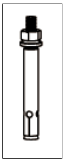
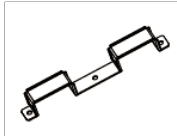
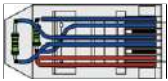
Part	Description	Part	Description
	Battery x 1		Plastic upper cover x 1
	Wall mount x 1		Expansion screw x 2

Part	Description	Part	Description
	Locking bracket x 2		<ul style="list-style-type: none"> • 35-8 OT terminal x 4: Recommended for connecting 25mm² or 35mm² cables • 50-8 OT terminal x 4: Recommended for connecting 50mm² cables • 70-10 OT terminal x 2: Recommended for connecting 70mm² cables
	14-5 Grounding terminal x 2		M5 Combination bolt x 7
	M10 Expansion bolt x 6		Cable harness fixing plate x 1
	Terminal resistor x 1		Product documentation x 1

3.2.3 Combiner Box Deliverables

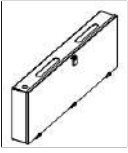
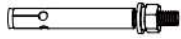
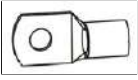

3.2.3.1 BCB-22-WW-0

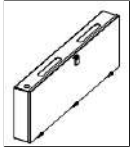
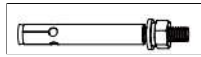
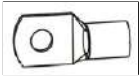

Part	Description	Part	Description
	BCB-22-WW-0 busbar box x 1		M6 expansion bolt x 4
	(25-8) OT terminal x 36 (70-10) OT terminal x 6	-	-

3.2.3.2 BCB-32-WW-0, BCB-33-WW-0 (optional)

Part	Description	Part	Description
	BCB-32-WW-0, BCB-33-WW-0 bus bar box x 1		M6 expansion bolt x 4
	(50-8) OT terminal x 30 (70-10) OT terminal x 6	-	-

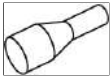
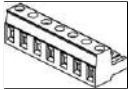
3.2.4 GM330

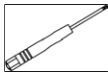





Part	Description	Part	Description
	Smart meter x1		2PIN communication terminal x1
	PIN terminal x 6		7PIN communication terminal x1

Part	Description	Part	Description
	screwdriver x1		Product documentation x 1

3.2.5 Smart Communication Stick Deliverables

3.2.5.1 Attachment List

This attachment list is applicable to the 4G Kit-CN-G20, 4G Kit-CN-G21, and 4G Kit-G20.

Component	Description	Component	Description
	4G Smart Communication Stick x1		Wrench x1
			Applicable only to scenarios without a configured SIM card. Applicable only to 4G Kit-G20.
	Product Documentation x1		Antenna x1 Applicable only to 4G Kit-G20.
	Waterproof Gasket x1 Applicable only to 4G Kit-G20.		Unlocking Tool x1 Applicable only to scenarios without a configured SIM card. Applicable only to 4G Kit-G20.

3.3 Storage

NOTICE

[1] The storage period starts from the SN date printed on the battery outer packaging. Charge-discharge maintenance is required after exceeding the storage period. (Battery maintenance time = SN date + charge-discharge maintenance cycle). For how to check the SN date, refer to: [11.4.SN Code Meaning\(Page 437\)](#).

[2] After passing the charge-discharge maintenance, if there is a Maintaining Label on the outer box, please update the maintenance information on the Maintaining Label. If there is no Maintaining Label, please record the maintenance time and battery SOC yourself and keep the data properly to maintain maintenance records.

If the device is not put into use immediately, please store it according to the following requirements. After long-term storage, the device must be inspected and confirmed by professionals before it can be used again.

1. If the inverter's storage time exceeds two years or the non-operational time after installation exceeds 6 months, it is recommended to undergo inspection and testing by professionals before being put into use.
2. To ensure the good electrical performance of the internal electronic components of the inverter, it is recommended to power it on every 6 months during storage. If it has not been powered on for more than 6 months, it is recommended to undergo inspection and testing by professionals before being put into use.
3. To protect battery performance and service life, it is advised to avoid long-term idle storage. Prolonged storage may cause deep discharge of the battery, leading to irreversible chemical degradation, capacity decay, or even complete failure. It is recommended to use it promptly. If the battery needs long-term storage, please maintain it according to the following requirements:

Battery Model	Initial SOC Range for Battery Storage	Recommended Storage Temperature	Charge/Discharge Maintenance Cycle ^[1]	Battery Maintenance Method ^[2]
LX A5.0-30	30%~40%	0~35 °C	-20~45°C, ≤6 months	
GW14.3-BAT-LV-G10	30%~40%	0~35°C		

Battery Model	Initial SOC Range for Battery Storage	Recommended Storage Temperature	Charge/Discharge Maintenance Cycle ^[1]	Battery Maintenance Method ^[2]
GW16.1-BAT-LV-G10)			-20~35°C, ≤12 months 35~45°C, ≤6 months	For maintenance methods, please consult the dealer or after-sales service center.
LX U5.0-30	30%~40%	0~35°C	-20~35°C, ≤12 months 35~45°C, ≤6 months	

Packaging Requirements:

Ensure that the outer packaging box is not removed and the desiccant inside the box is not lost.

Environmental Requirements:

1. Ensure that the device is stored in a cool place, avoiding direct sunlight.
2. Ensure the storage environment is clean, with appropriate temperature and humidity ranges, and no condensation. If there is condensation on the device ports, do not install the device.
3. Ensure that the device is stored away from flammable, explosive, corrosive, and other hazardous materials.

Stacking Requirements:

1. Ensure that the inverter stacking height and direction are arranged according to the instructions on the packaging box label.
2. Ensure that there is no risk of tipping after the inverters are stacked.

4 Installation



When performing device installation and electrical connections, please use the delivery items shipped with the box. Otherwise, any device damage caused will not be covered under warranty.

4.1 System Installation and Commissioning Procedure

Steps	1 Installation	2 PE	3 PV	4 Battery	5 AC	6 COM	7 Communication module	
Inverter							4G Kit-CN-G20 COM3 4G Kit-G20 COM3	
Tools	1 D: 65mm φ: 13mm 2 M10 24N-m 3 M6 4.3N-m	M5 2.5-3N-m	Recommend: PV-CZM-G1100 	1 M16+2.0 13N-m 2 M25 5-6N-m	1 M8 8N-m 2 M32 7-8N-m 3 M5 2.5-3N-m 4 M40 9-10N-m	M25 5-6N-m	WIFI/LAN Kit-20 COM3	
Steps	1 Installation				2 PE	3 Battery	4 COM	
Battery	LX A5.0-30			LX U5.0-30		LX A5.0-30 LX U5.0-30	LX A5.0-30 LX U5.0-30	
Tools	1 M4 1.4N-m 2 M6 6N-m	1 D: 80mm φ: 8mm 2 M6 6N-m 3 M4 1.4N-m	1 D: 80mm φ: 8mm 2 M6 6N-m 3 M4 1.4N-m	1 M5 4N-m 2 ST5.5*70 10N-m	M10 6N-m	M5 4N-m M5 4N-m	M8 12N-m	
Steps	1 Installation				2 PE	3 Battery	4 COM	
Battery	GW16.1-BAT-LV-G10			GW14.3-BAT-LV-G10	GW16.1-BA-T-LV-G10	GW14.3-BAT-LV-G10	GW16.1-BA-T-LV-G10	
Tools	1 ST5.5 4N-m 2 M5 4N-m 3 M10 15N-m 4 M10 20N-m	1 D: 80mm φ: 10mm 2 D: 65mm φ: 12mm 3 M10 15N-m 4 M10 20N-m	1 D: 80mm φ: 10mm 2 ST5.5 4N-m 3 M5 4N-m 4 M10 15N-m 5 M5 4N-m	1 D: 80mm φ: 10mm 2 M10 15N-m 3 M5 4N-m	M5 4N-m	M5 4N-m	M10 15N-m	
ETL10IN0007								
Steps	1 Installation	2 Cable Connections		3 Power	4 Commissioning			
Smart meter	GM330	 N/L1/L2/L3 N/L1/L2/L3	 RS485 RS485A 0.5N-m 1-1.5N-m 0.5N-m	 AC breaker	 SolarGo App	 SEMS+ App	 SEMS+ WEB	
ETL10IN0010								

4.2 Installation Requirements

4.2.1 Installation Environment Requirements

1. The device must not be installed in flammable, explosive, corrosive, or similar environments.
2. The temperature and humidity of the device installation environment must be within a suitable range.
3. The installation location must be out of reach of children and avoid being placed in easily accessible positions.
4. When the inverter is operating, the enclosure temperature may exceed 60°C. Do not touch the enclosure before it cools down to prevent burns.
5. The device should avoid installation environments with direct sunlight, rain, snow accumulation, etc. It is recommended to install it in a sheltered location. If necessary, a sunshade can be built.
6. Direct sunlight, high temperatures, and other adverse environmental conditions may cause the inverter output power to derate.
7. The installation space must meet the ventilation, heat dissipation, and operational space requirements of the device.
8. The installation environment must satisfy the device's protection rating. The inverter, battery, and smart communication stick are suitable for indoor and outdoor installation; the electricity meter is suitable for indoor installation.
9. The device installation height should facilitate operation and maintenance, ensuring that device indicator lights, all labels are easily visible, and wiring terminals are easy to operate.
10. The device installation altitude should be below the maximum operating altitude.
11. Before installing the device outdoors in salt-affected areas, consult the device manufacturer. Salt-affected areas mainly refer to regions within 500m of the coast. The affected area is related to sea breeze, precipitation, terrain, and other conditions.
12. The length of DC lines and communication lines between the battery and inverter must be less than 3m. Ensure that the installation distance between the inverter and battery meets the cable length requirements.
13. Stay away from strong magnetic field environments to avoid electromagnetic interference. If there are radio stations or wireless communication devices below 30MHz near the installation location, install the device according to the following requirements:
 - Inverter: Add ferrite cores with multiple turns on the inverter DC input lines or AC

output lines, or add low-pass EMI filters; or the distance between the inverter and the wireless electromagnetic interference device should exceed 30m.

- Other devices: The distance between the device and the wireless electromagnetic interference device should exceed 30m.

NOTICE

If installed in an environment below 0°C, the battery may become unable to recharge and recover energy after being depleted, resulting in battery undervoltage protection.

- LX A5.0-30, LX U5.0-30, GW14.3-BAT-LV-G10, GW16.1-BAT-LV-G10: Charging temperature range: $0^{\circ}\text{C} < T \leq 55^{\circ}\text{C}$; Discharging temperature range: $-20^{\circ}\text{C} < T \leq 55^{\circ}\text{C}$
- For batteries with the optional heating film:
 - LX U5.0-30: Charging temperature range: $-20^{\circ}\text{C} < T \leq 55^{\circ}\text{C}$; Discharging temperature range: $-20^{\circ}\text{C} < T \leq 55^{\circ}\text{C}$

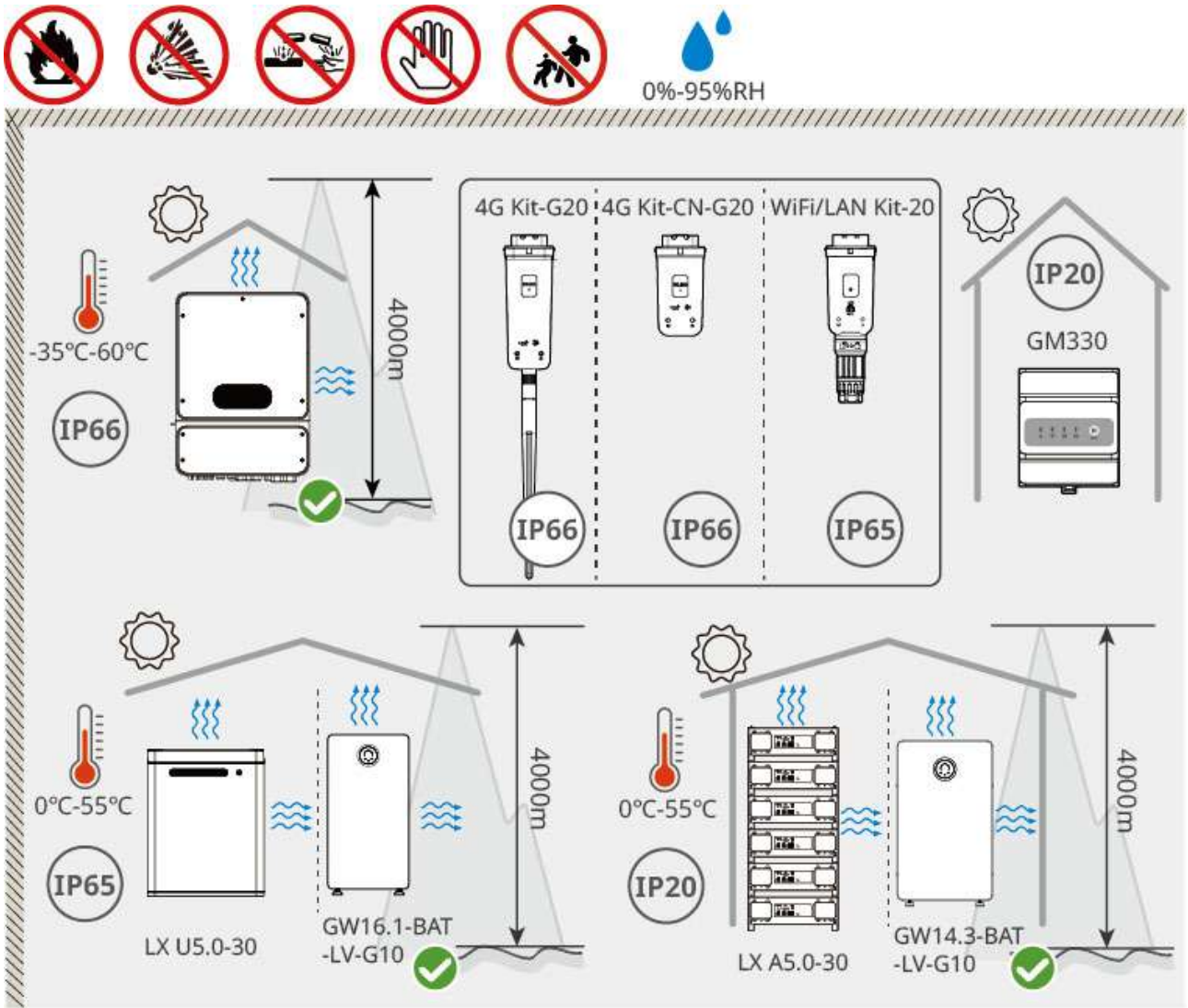

ETL10INT0005

4.2.2 Installation Space Requirements

When installing devices in the system, sufficient space should be reserved around the devices to ensure adequate installation and heat dissipation space.

- When using CAT 7E communication cables between inverters, the cable distance should not exceed 10 meters; when using CAT 5E or CAT 6E communication cables, the cable distance should not exceed 5 meters. Do not exceed 10m for communication cables, otherwise it may cause communication abnormalities.
- For installing CT, use shielded network cables of CAT 5E or above, with a cable distance not exceeding 30 meters.
- For RS485 twisted-pair shielded cables used for communication between inverters and meters, the cable distance should not exceed 100 meters.

Communication Cable Length

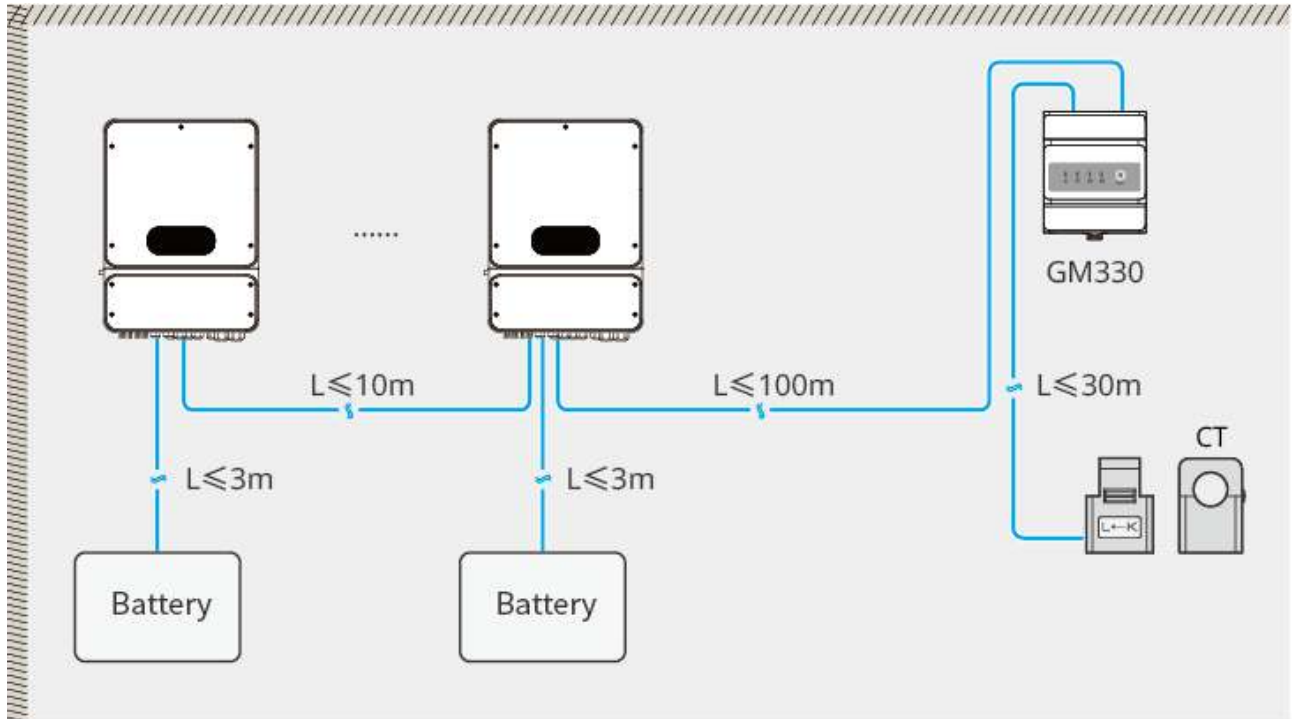

ETL10INT0009

Installation Space

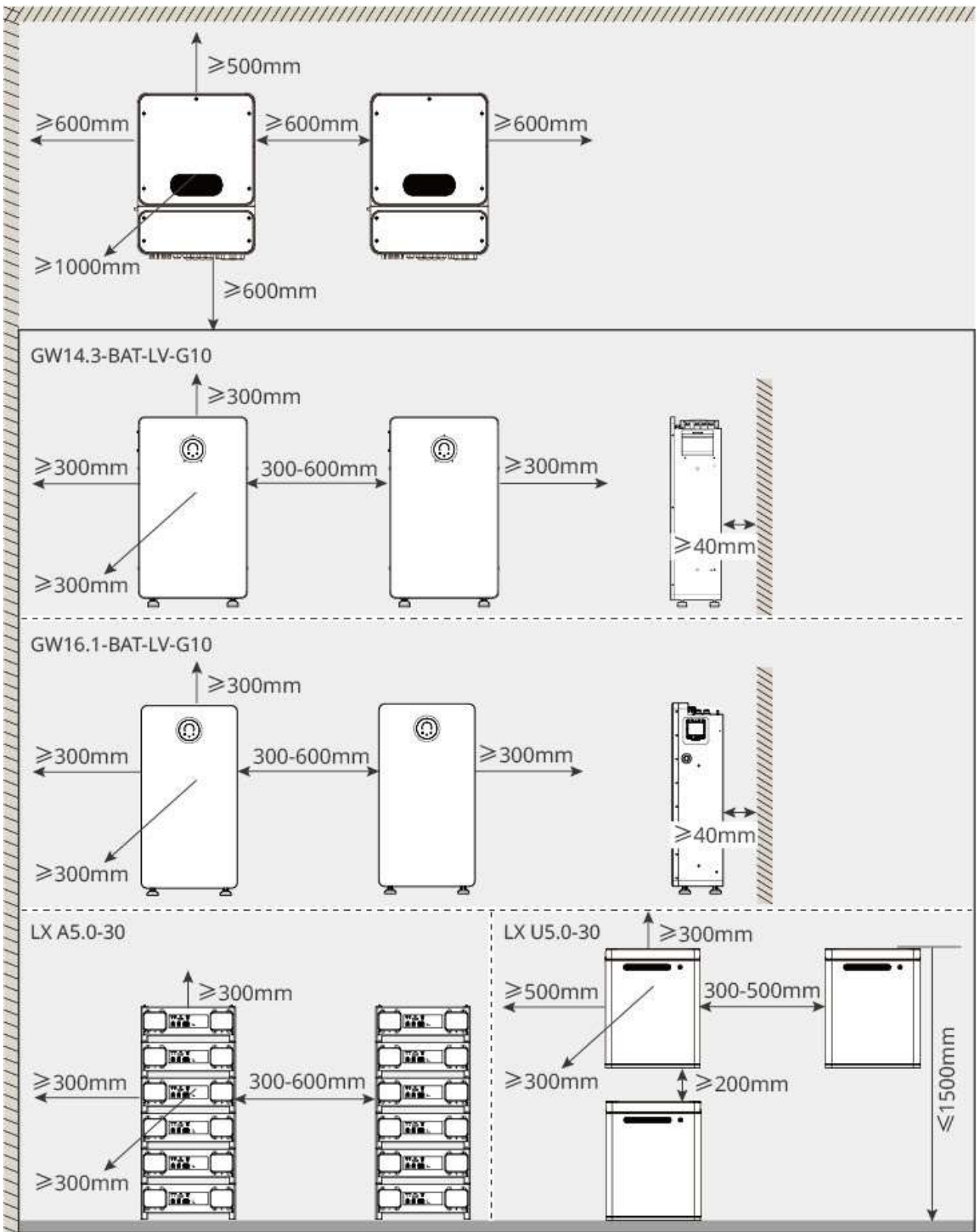

ETL10INT0006





4.2.3 Tool Requirements

NOTICE

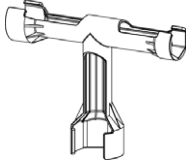

During installation, it is recommended to use the following installation tools. If necessary, other auxiliary tools can be used on-site.

Installation Tools

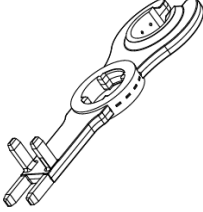
Tool Type	Description	Tool Type	Description
	diagonal plier		RJ45 connector crimping tool
	wire stripper		Level bar
	open-end wrench		PV terminal crimping tool A-2546B
	hammer drill (drill bit Φ 13mm)		torque wrench M4, M5, M6, M8
	rubber hammer		socket wrench
	marker pen		multimeter Range \leq 1000V
	heat shrink tubing		heat gun

Tool Type	Description	Tool Type	Description
	cable tie		vacuum cleaner
	flat-head screwdriver		Gland head unlocking tool Note: If needed, please contact your distributor or GoodWe to purchase.
	Inverter battery cable crimping tool HS-95WF		Hex key M16, M8
	(China only) PV unlocking tool	-	-

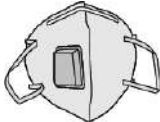
personal protective equipment

Tool Type	Description	Tool Type	Description
	Insulated gloves, protective gloves		Dust mask
	goggle		Safety shoes

4.3 Equipment Handling

 CAUTION

1. During operations such as transportation, handling, and installation, the laws, regulations, and relevant standard requirements of the country/region must be met.
2. Before installation, the equipment needs to be moved to the installation site. To avoid personal injury or equipment damage during handling, please note the following:
3. Assign personnel according to the weight of the equipment to prevent it from exceeding the human lifting capacity and causing injury from dropping.
4. Please wear safety gloves to avoid injury.
5. Ensure the equipment remains balanced during handling to prevent it from falling.
6. The battery system can be removed from the packaging using a crane or hoisting method and transported to the installation location.
 - Crane requirements (GW14.3-BAT-LV-G10, GW16.1-BAT-LV-G10): Lifting capacity \geq 180kg
7. When using hoisting to move the equipment, please use flexible lifting slings or straps. Requirements for the lifting lugs and slings of GW14.3-BAT-LV-G10 and GW16.1-BAT-LV-G10:
 - Lifting lugs: 4 x M10 lifting lugs, each with a load capacity \geq 260 kg
 - Lifting sling: 1 piece, rope length \geq 2.5m, sling load capacity \geq 600kg

GW14.3-BAT-LV-G10:

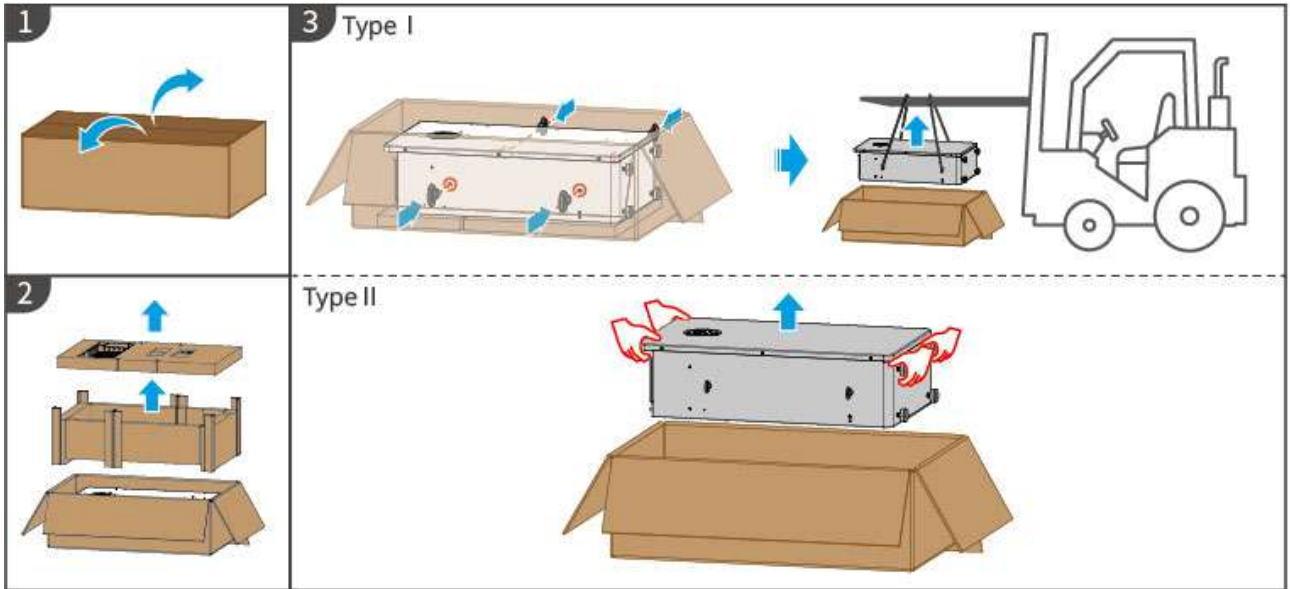

LXA10INT0010

GW16.1-BAT-LV-G10:

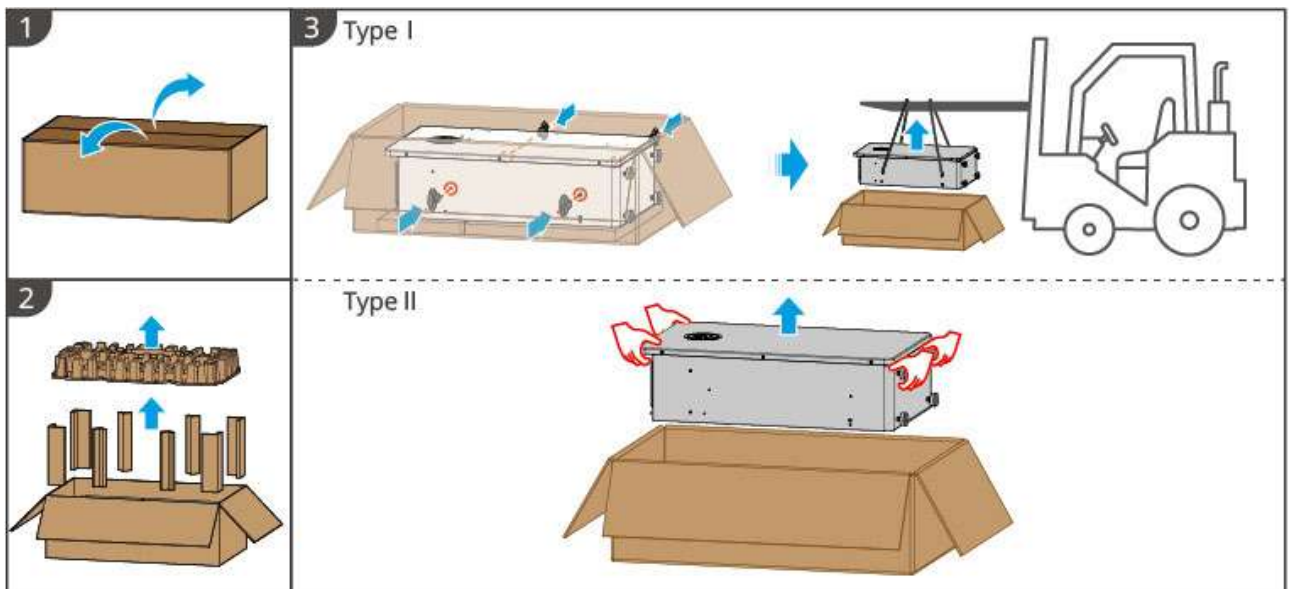

LXA40INT0005

4.4 Installing the Inverter

 CAUTION

- When drilling holes, ensure the drilling location avoids water pipes, cables, etc. inside the wall to prevent danger.
- When drilling, please wear safety goggles and a dust mask to avoid inhaling dust into the respiratory tract or getting it in the eyes.
- Ensure the inverter is installed securely to prevent it from falling and injuring personnel.

1. Place the mounting plate horizontally against the wall and use a marker to mark the drilling positions.
2. Use an impact drill to create the holes.
3. Secure the inverter mounting plate bracket to the wall using expansion screws.
4. (Optional) Install the lifting handle onto the inverter.
5. Hang the inverter onto the mounting plate. After hanging, use screws to secure the mounting plate to the inverter, ensuring the inverter is firmly installed.
6. (Optional) Install the anti-theft lock.

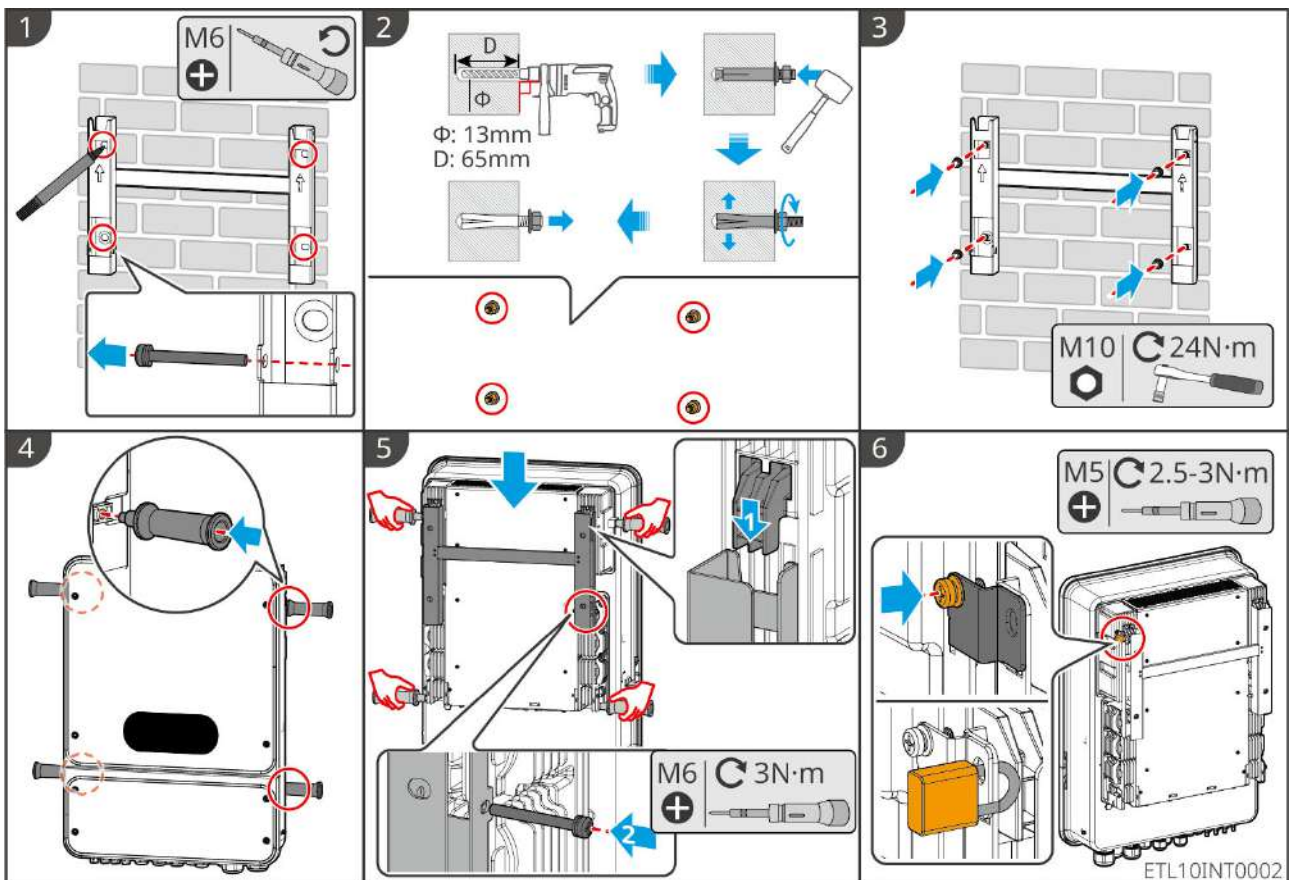

4.5 Installing the Battery System

4.5.1 LX A5.0-30

LX A5.0-30: Floor Stacking

NOTICE

Ground stacking supports a maximum of 6 batteries

1. Place the battery vertically and remove the battery handle.
2. Install the bracket onto the battery and secure it with screws.
3. Lay the battery flat and stack multiple batteries for installation. Ensure the locating pins are inserted into the locating holes.

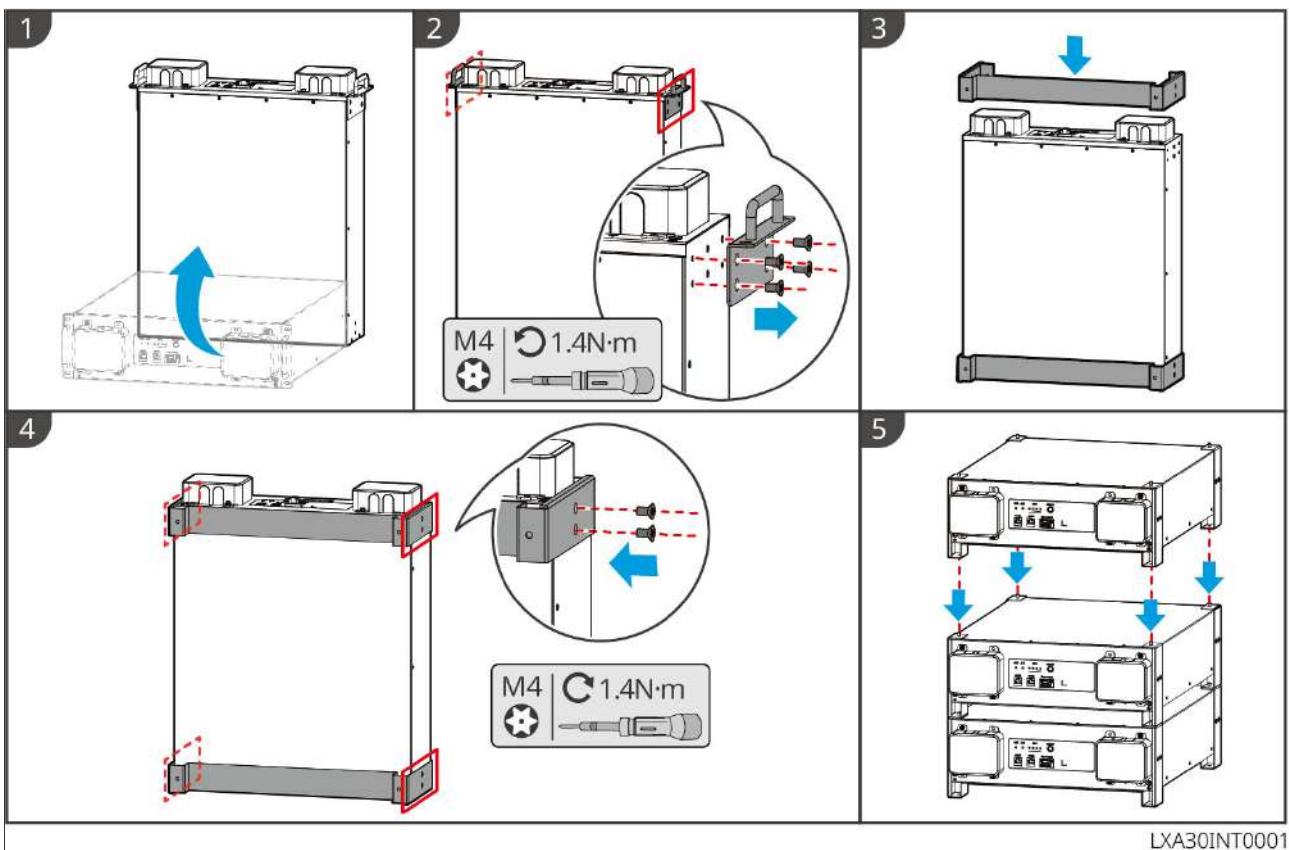

LX A5.0-30: Cabinet Installation

NOTICE

- It is recommended to install in a 19-inch standard cabinet with dimensions of length*width: 600*800mm or larger, and height should be selected based on the battery thickness (133mm) or greater.
- For cabinet installation, electrical labels and warning labels need to be pasted on the front panel of any battery (these labels are shipped as additional accessories).

1. Place the battery onto the cabinet's rails and secure the battery to the cabinet with screws from the handle area.

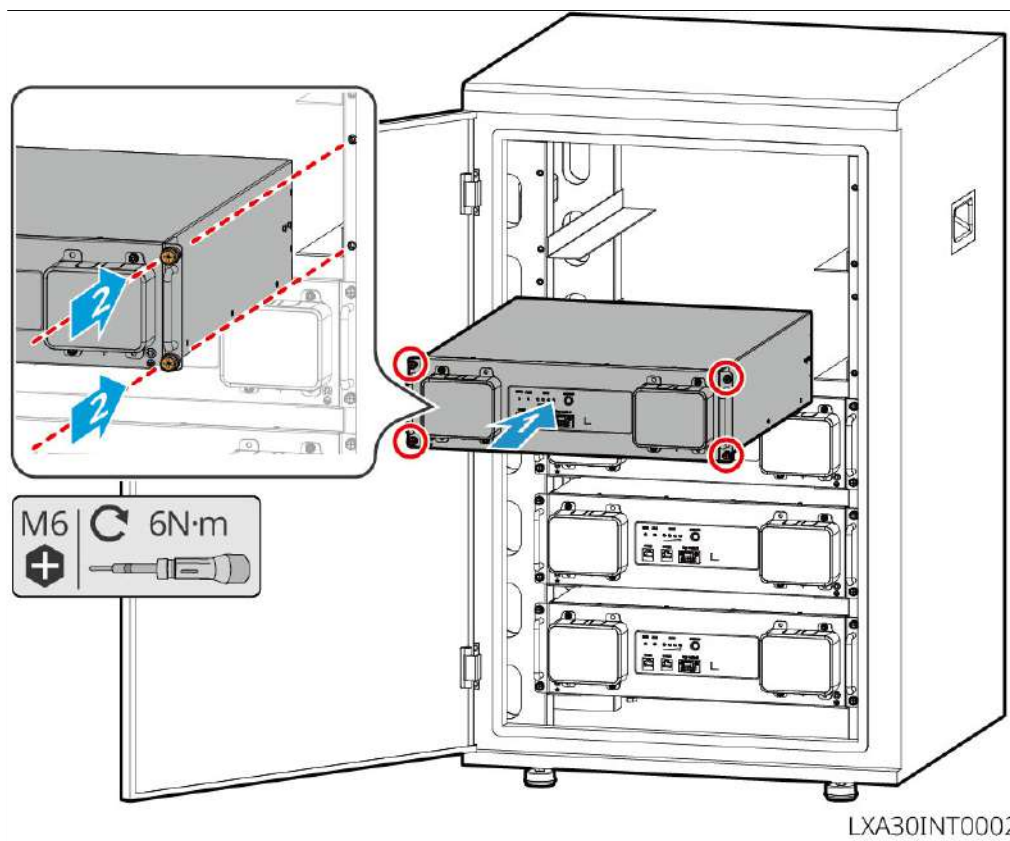

LX A5.0-30: Wall Mounting

1. Determine the drilling positions according to the marking template and mark them with a marker pen.
2. Use an impact drill to create the holes.
3. Install the battery wall bracket.
4. Mount the battery onto the bracket and secure the connection between the battery

and the bracket with screws.

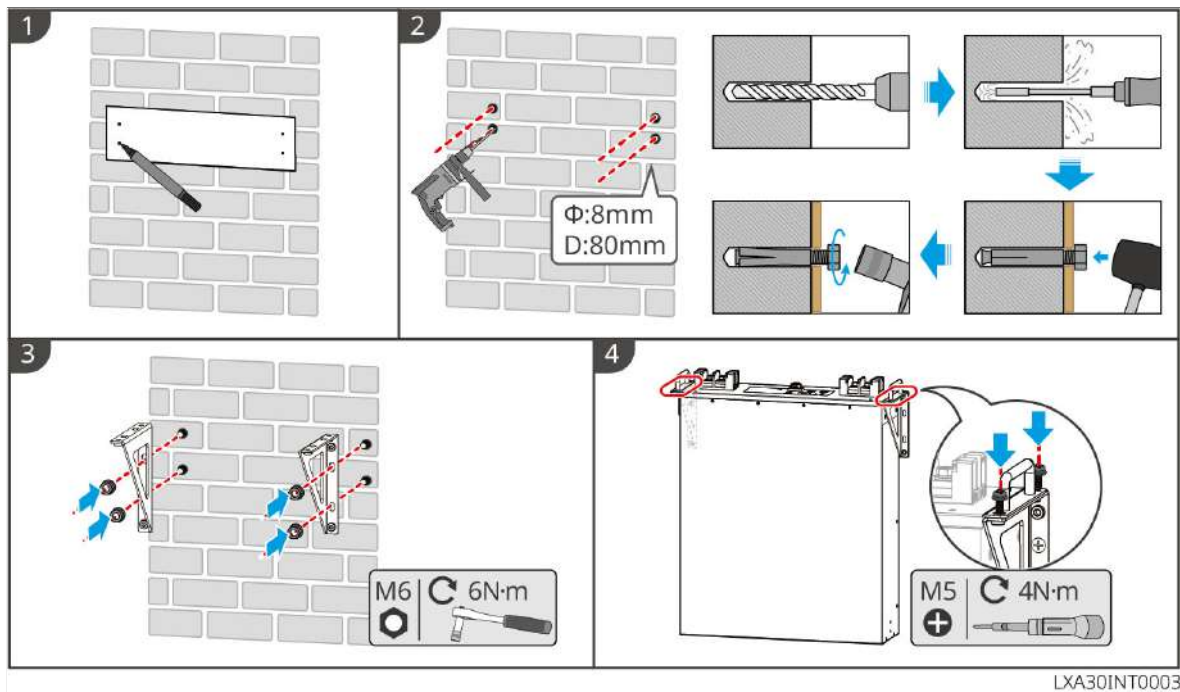

4.5.2 GW14.3-BAT-LV-G10

NOTICE

- Wall mounting requires installation by two people.

GW14.3-BAT-LV-G10: Floor Installation

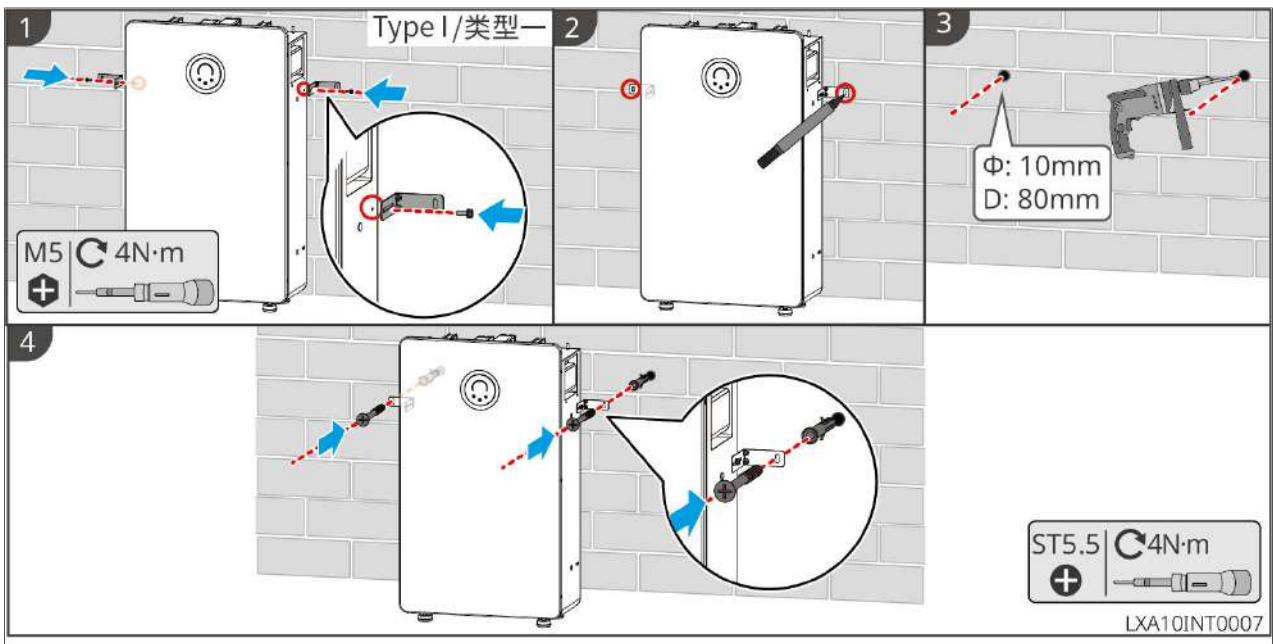

GW14.3-BAT-LV-G10: Wall-mounted Installation

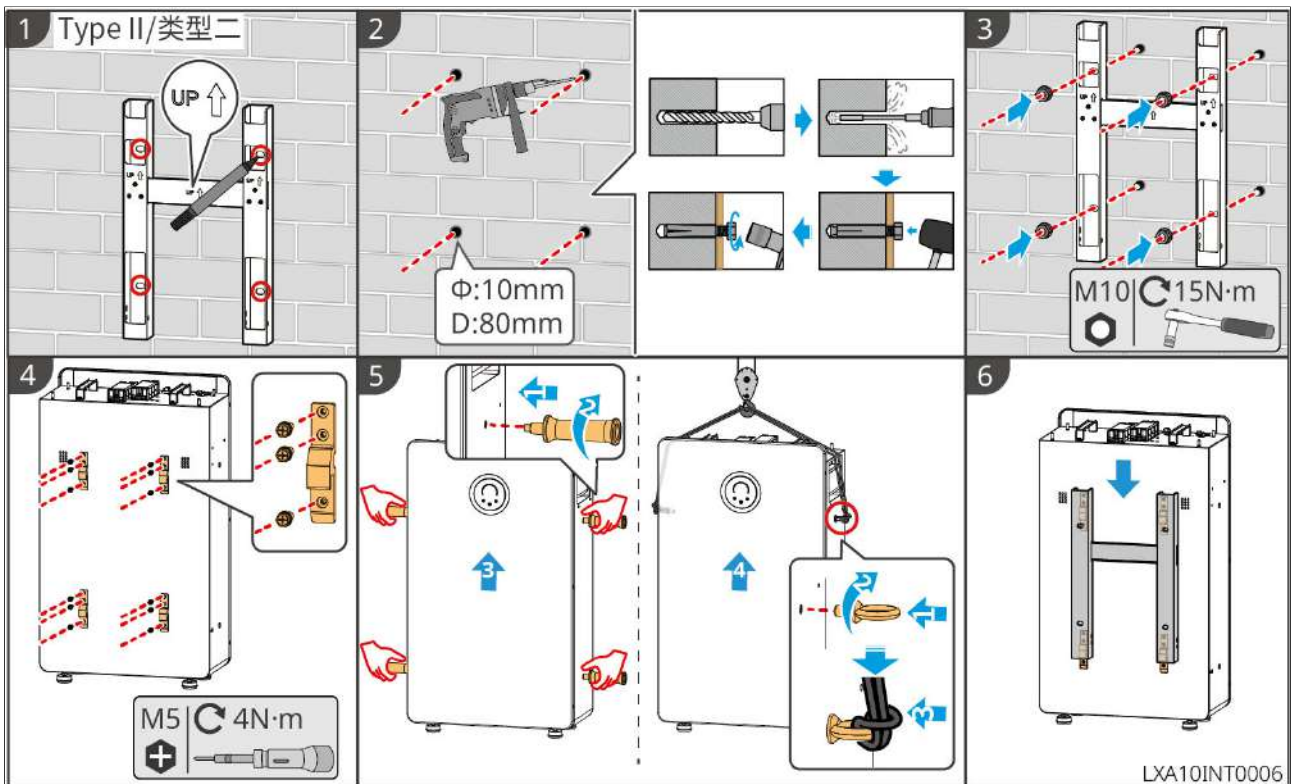

4.5.3 LX U5.0-30

LX U5.0-30: Floor installation

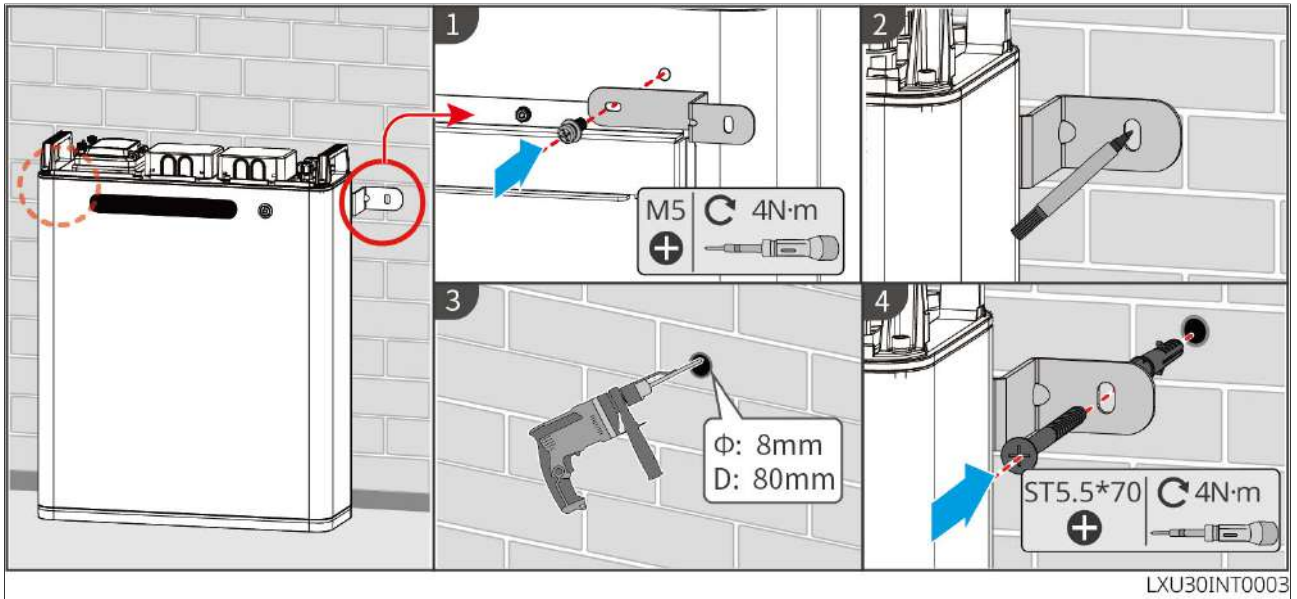

LX U5.0-30: Wall-mounted installation

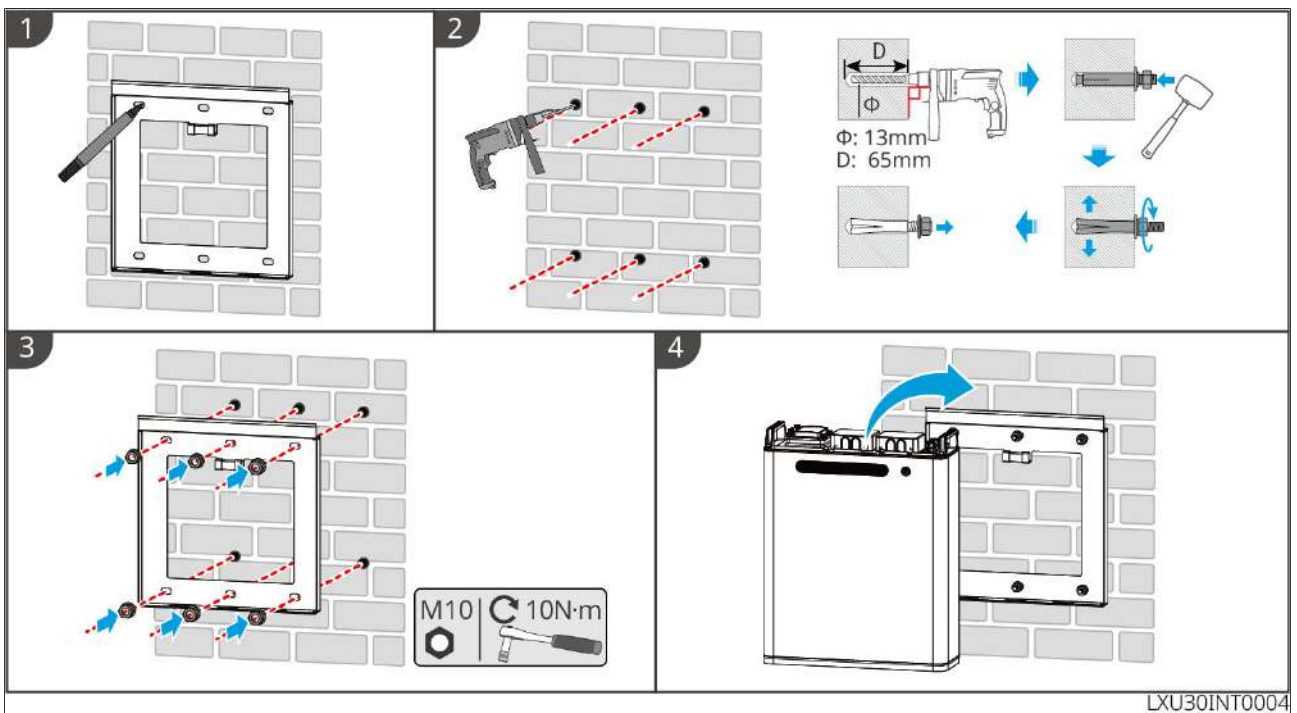

4.5.4 GW16.1-BAT-LV-G10

NOTICE

- Wall mounting requires two people for installation.

Floor installation

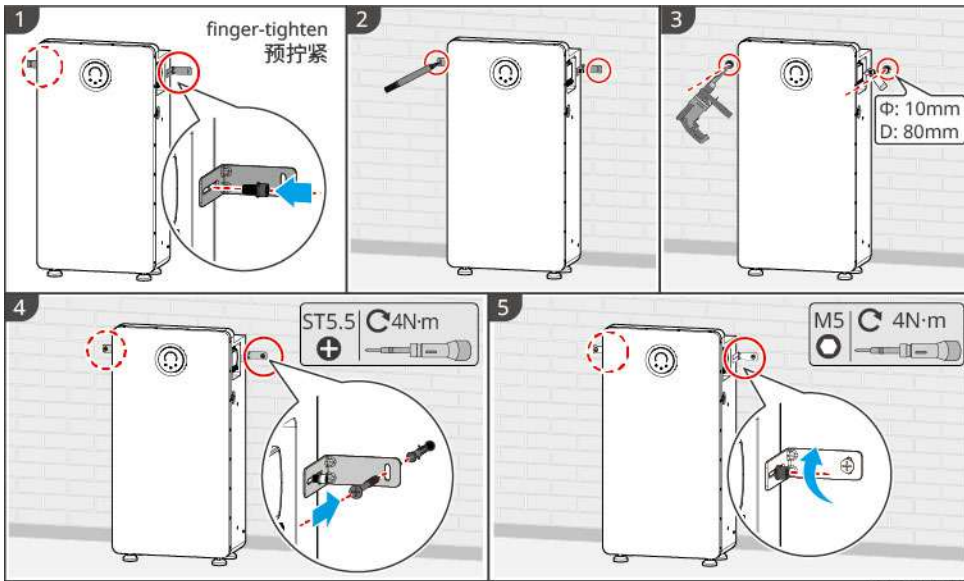

LXA40INT0002

Wall-mounted installation

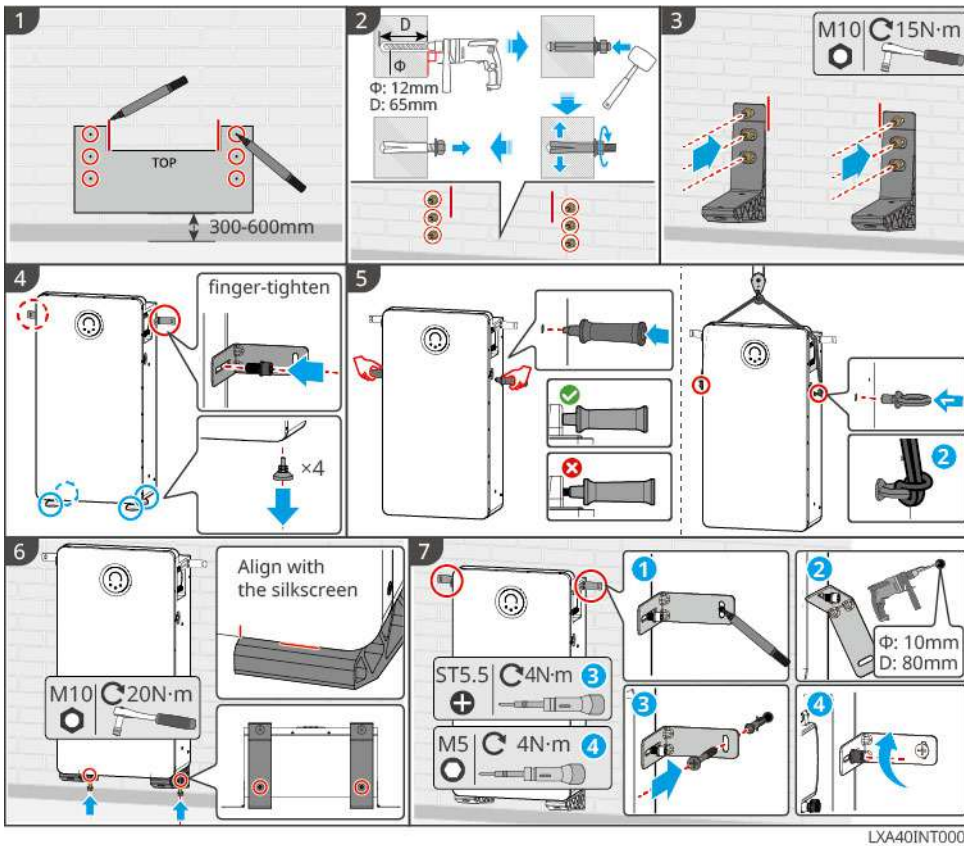

4.6 Installing the Smart Meter

⚠ WARNING

In areas with lightning danger, if the meter cable length exceeds 10m and the cable is not wired with grounded metal conduit, it is recommended to install external lightning protection devices.

GM330

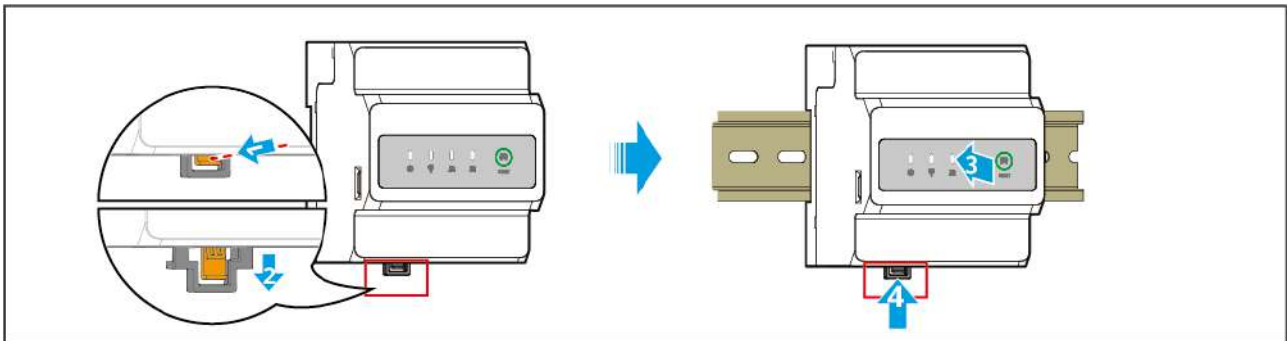

5 System Wirings

DANGER

- The installation, routing, and connection of cables must comply with local laws, regulations, and code requirements.
- All operations during electrical connection, as well as the specifications of cables and components used, must meet local legal and regulatory requirements.
- Before performing any electrical connection, disconnect the DC switch and AC output switch of the equipment to ensure the equipment is powered off. Live work is strictly prohibited, as it may lead to hazards such as electric shock.
- Cables of the same type should be bundled together and separated from different types of cables. Intertwining or crossing of cables is prohibited.
- If the cable is subjected to excessive tension, poor connection may result. When connecting, leave a certain length of slack in the cable before connecting it to the inverter terminal ports.
- When crimping terminals, ensure the conductor part of the cable makes full contact with the terminal. Do not crimp the cable insulation together with the terminal, as this may cause equipment malfunction or, after operation, lead to inverter terminal damage due to unreliable connections causing overheating.

NOTICE

- When performing electrical connections, wear personal protective equipment such as safety shoes, protective gloves, and insulating gloves as required.
- Only qualified personnel are permitted to perform electrical connection operations.
- The cable colors shown in the graphics in this document are for reference only. Specific cable specifications must comply with local regulations.
- For parallel systems, please adhere to the safety precautions in the user manuals corresponding to the related products within the system.

5.1 System Wiring Electrical Block Diagram

NOTICE

- Depending on the regulatory requirements of different regions, the wiring methods for the N and PE lines of the inverter's ON-GRID and BACK-UP ports are different. Please refer to local regulations for specifics.
- The inverter has a built-in energy meter and can be directly connected to CT for use. The CT cable shipped with the box is 10 meters. If a longer distance is required, it can be extended to 30 meters using shielded cables that comply with local regulations.
- When the connection length between CT and the inverter exceeds 30m, accuracy will decrease. If high accuracy is required, an external smart meter can be connected.
- The inverter's ON-GRID and GEN AC ports have built-in relays. When the inverter is in off-grid mode, the built-in ON-GRID relay is in the open state; when the inverter is in grid-connected operation mode, the built-in ON-GRID relay is in the closed state.
- After the inverter is powered on, the BACK-UP AC port is live. If maintenance is required for BACK-UP Loads, please power off the inverter; otherwise, it may cause electric shock.

N and PE wires are connected together in the distribution box

NOTICE

- To maintain neutral integrity, the neutral wires on the grid-connected side and off-grid side must be connected together; otherwise, the off-grid function cannot be used normally.
- The following diagram is a schematic of the grid system for regions such as Australia and New Zealand.

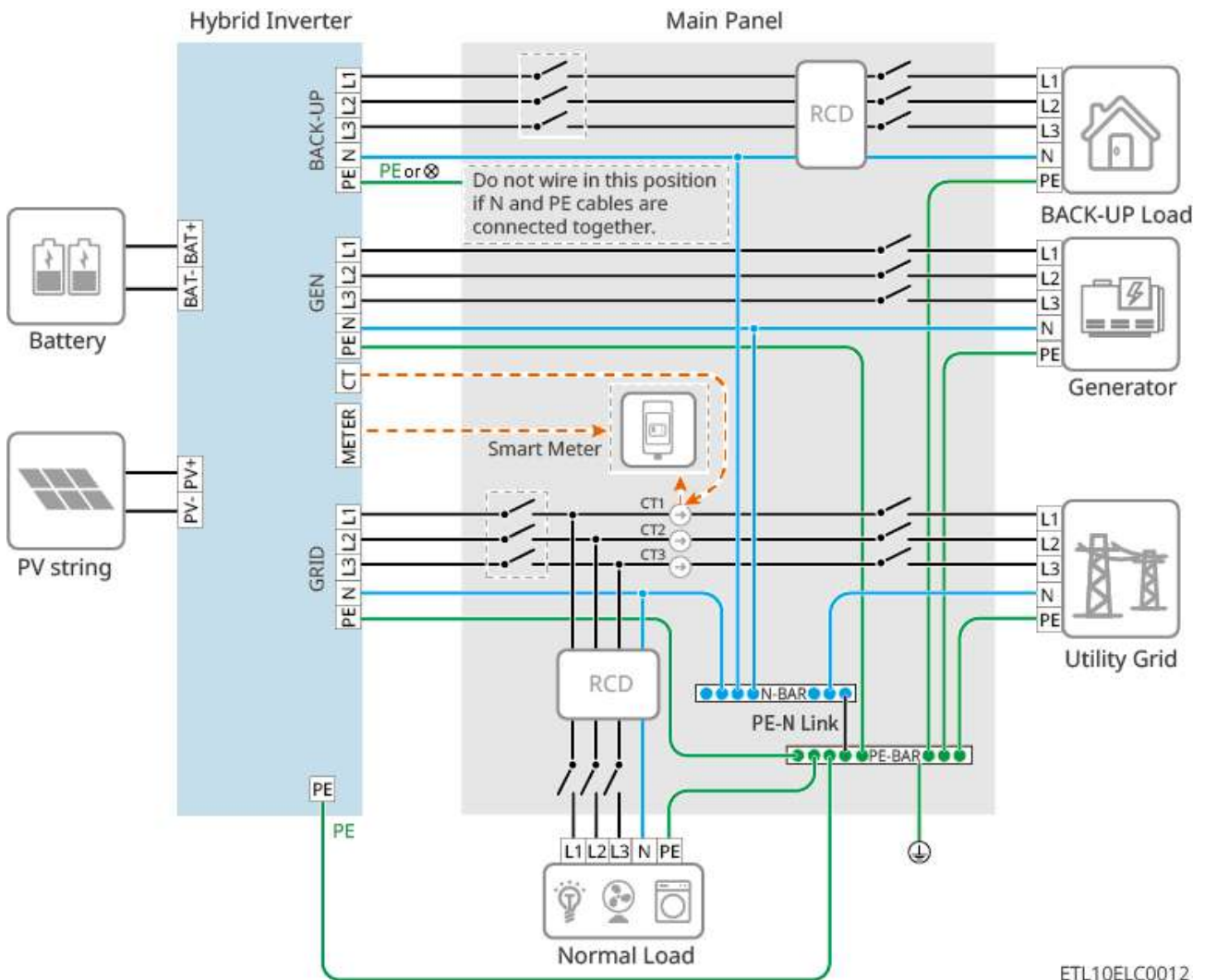

ETL10ELC0012

N and PE wires are connected separately in the distribution box

NOTICE

- Please ensure the protective ground wire of BACK-UP is connected correctly and securely, otherwise the BACK-UP function may malfunction when a grid fault occurs.
- Other regions except Australia, New Zealand, etc. are applicable to the following wiring methods:

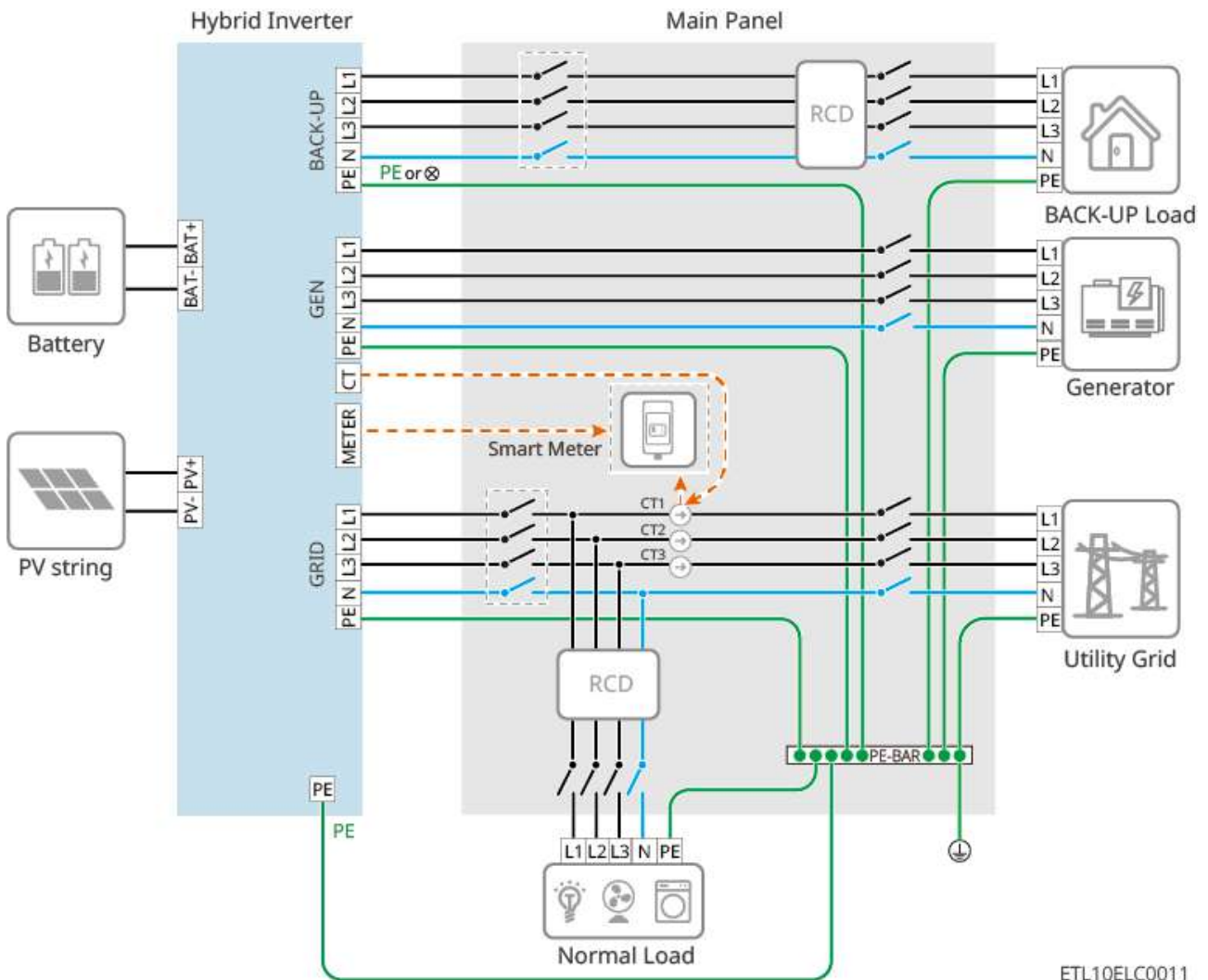

ETL10ELC0011

5.2 Detailed System Wiring Diagram

When all loads in the photovoltaic system cannot consume the electricity generated by the system, the surplus electricity is fed into the grid. At this time, it can be paired with a smart meter or CT monitoring system to monitor the power generation and control the amount of electricity fed into the grid.

- Connecting a smart meter enables output power limiting and load monitoring functions.
- After connecting the smart meter, please enable the 'Export power limit' function via the App.

The Detailed System Wiring Diagram only shows wiring examples for some model devices. Please refer to the corresponding wiring guidance chapter for the actual

devices used when wiring.

NOTICE

- The GM330 meter is optional. If needed, please contact your distributor or GoodWe to purchase.
- Energy storage inverters do not support parallel operation in microgrid scenarios.
- If output power limitation is required for a grid-tied inverter, please connect a separate meter or CT device.
- When not using the inverter's built-in meter, do not connect to the inverter's CT port.

5.2.1 Detailed System Wiring Diagram for Single Inverter

General Scenario

Scenario with Built-in Meter

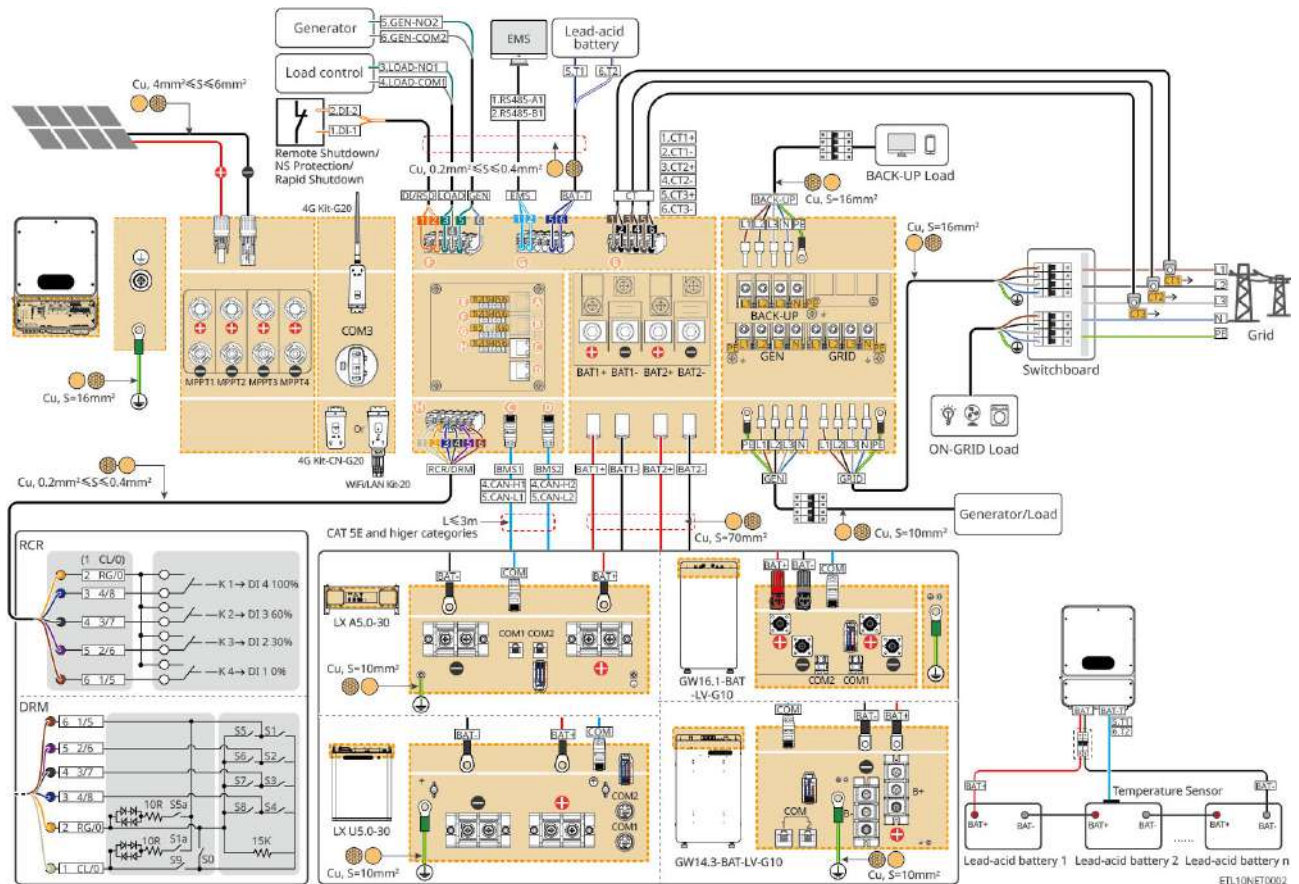

Scenario with GM330

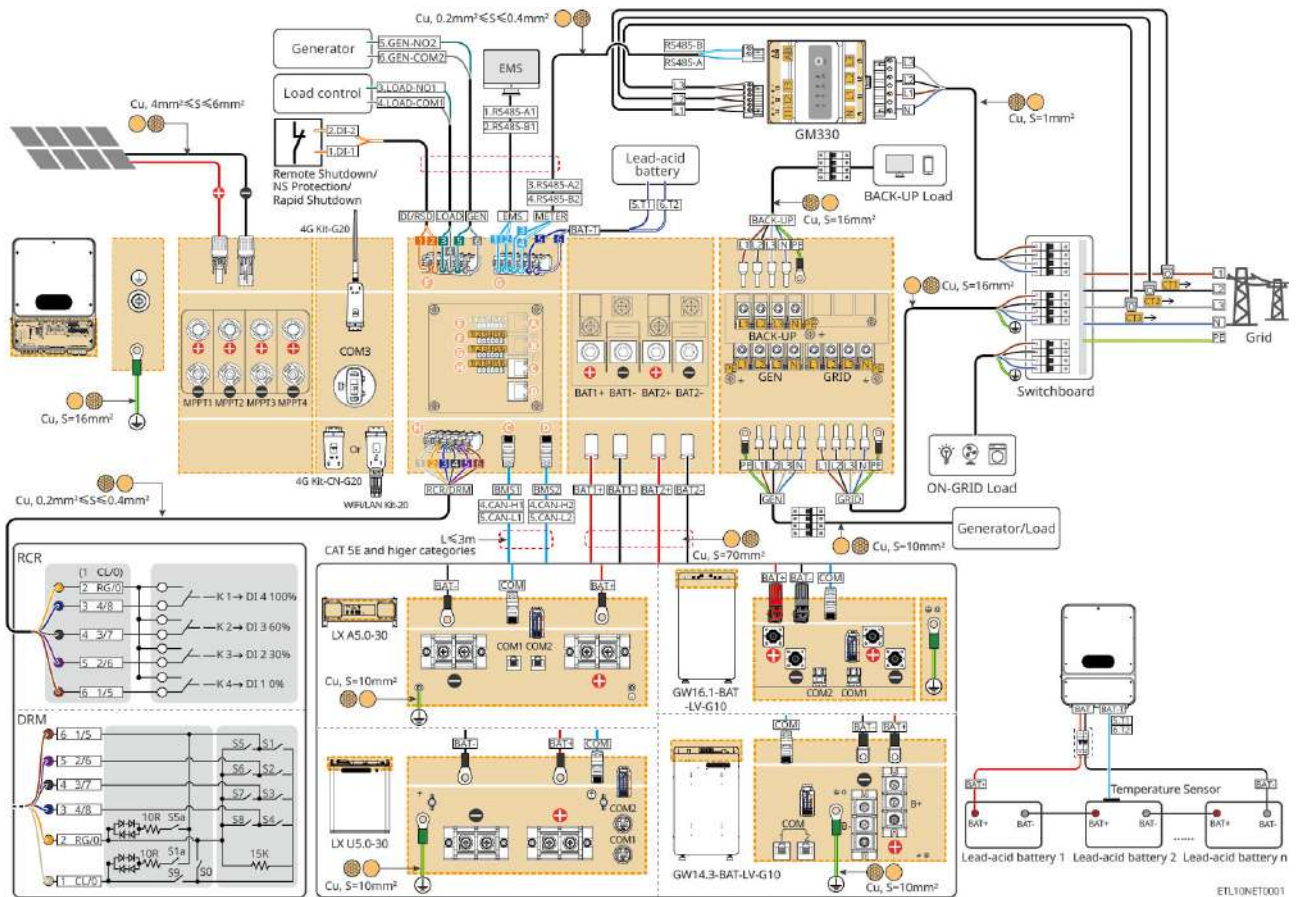

Microgrid Scenario

For grid-tied inverters in a microgrid scenario requiring output power limitation, please connect a separate meter or CT device.
 Scenario with Built-in Meter

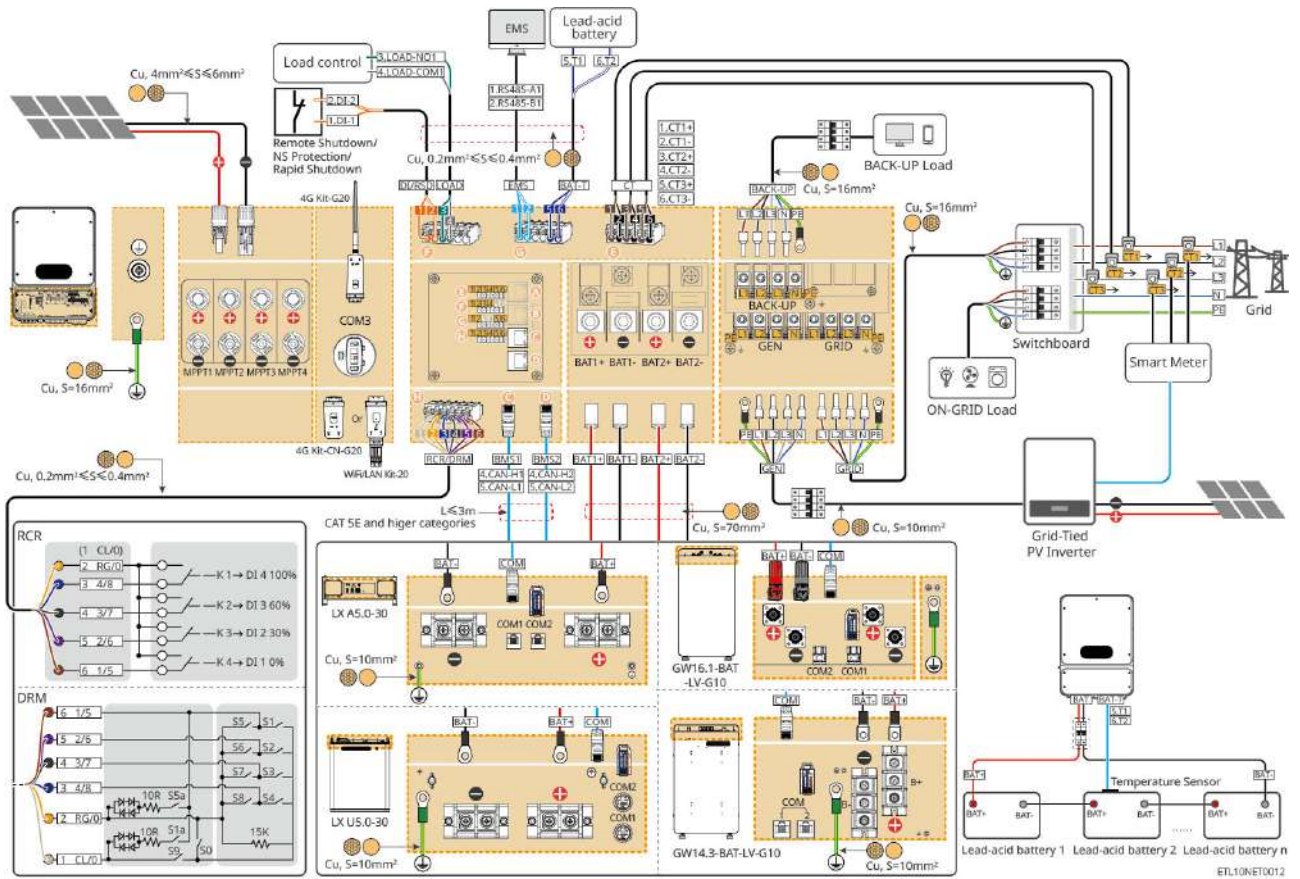

Scenario with GM330 Meter

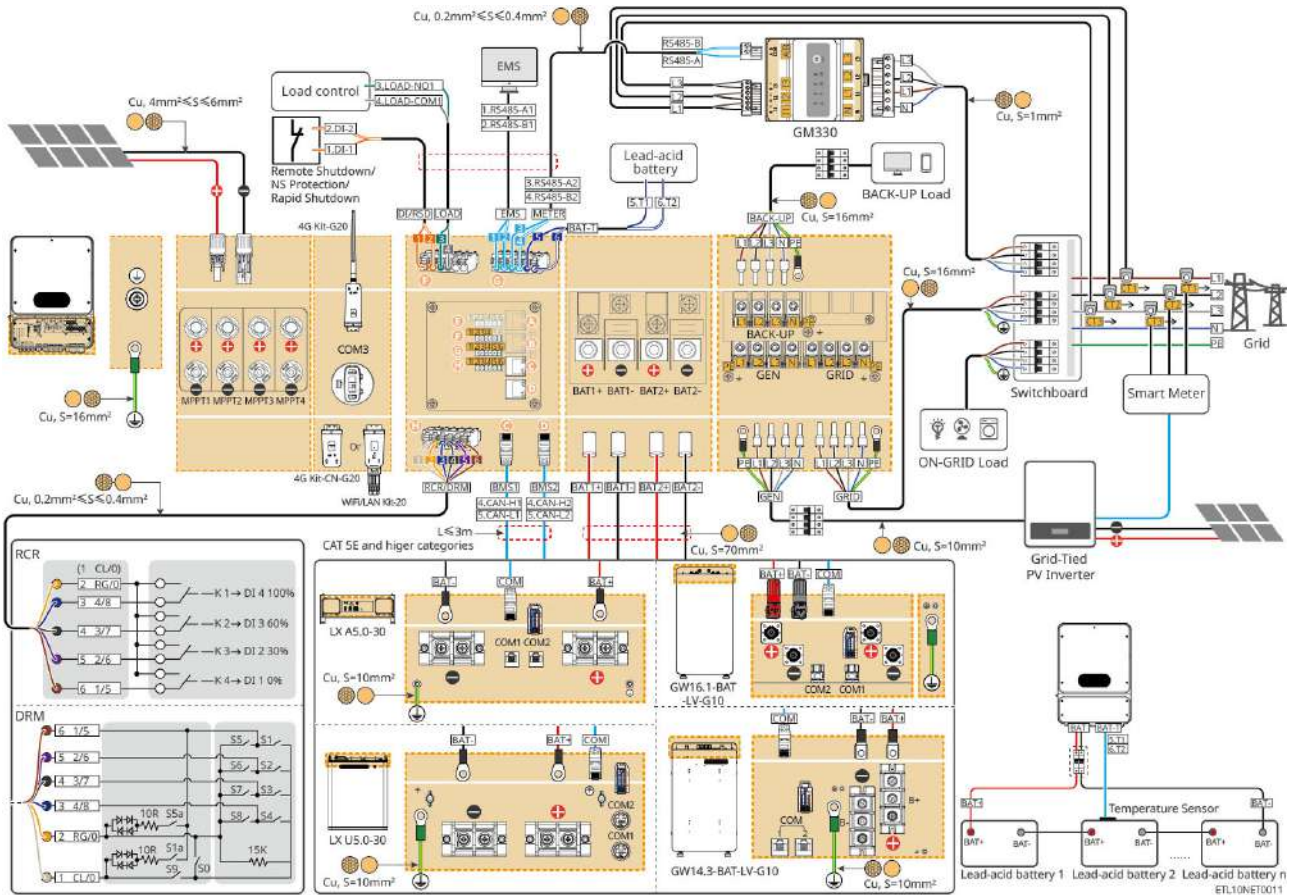

Coupling Scenario

For grid-tied inverters in a coupling scenario requiring output power limitation, please connect a separate meter or CT device.

Scenario with Built-in Meter

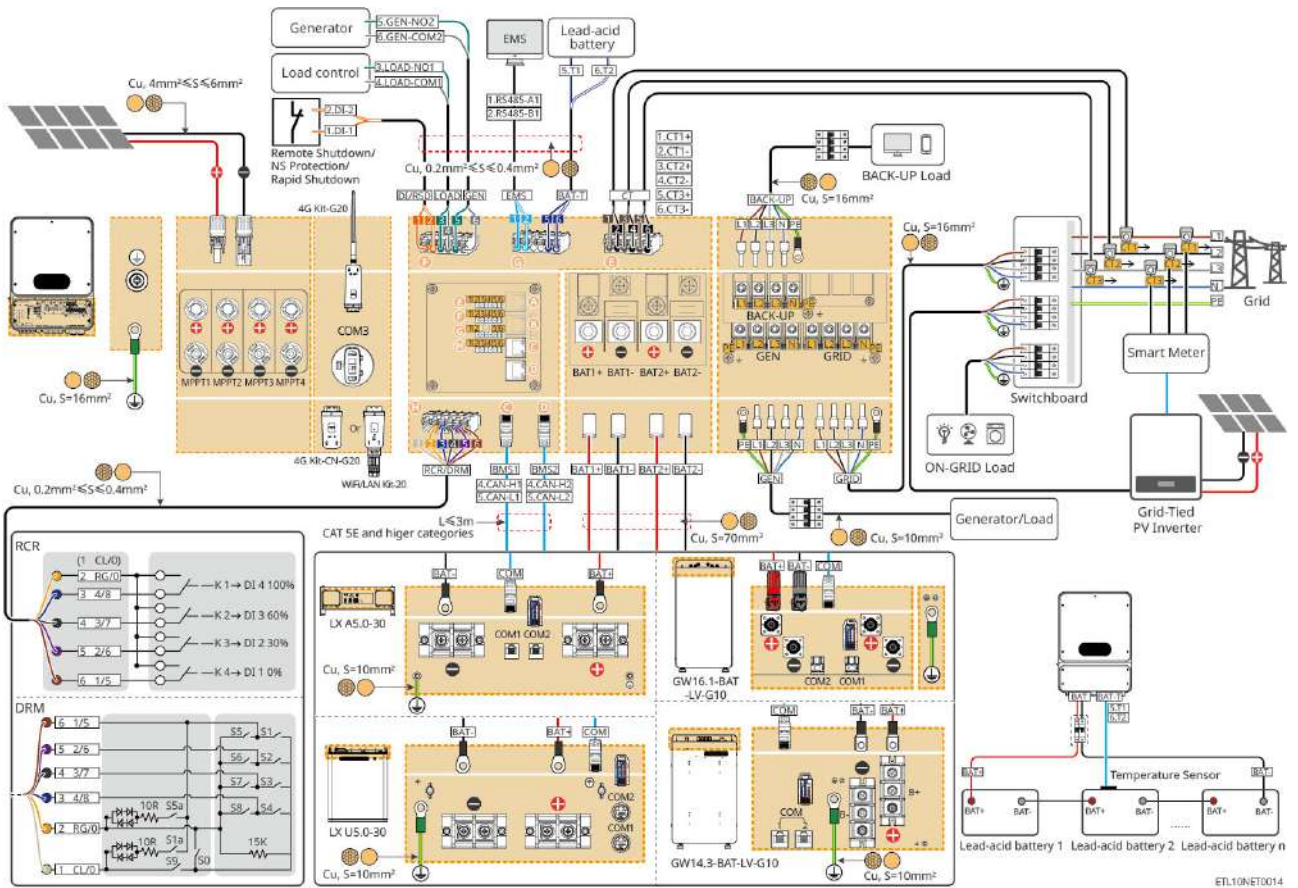

ETL10NET0014

Scenario with GM330 Meter

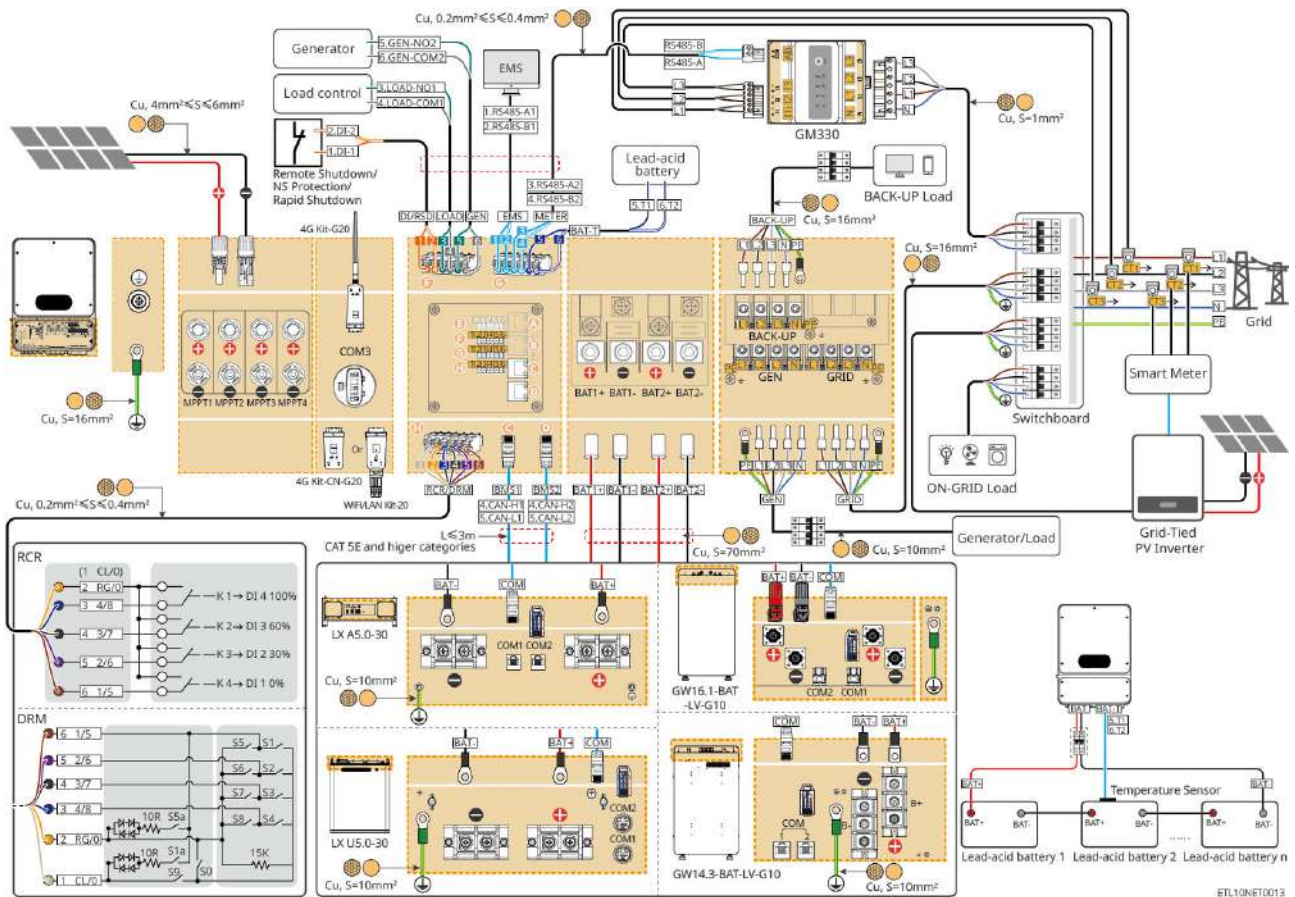

5.2.2 Detailed System Wiring Diagram for Parallel System

NOTICE

- If the system requires connecting DRED devices, RCR devices, Remote Shutdown devices, NS Protection, SG Ready heat pumps, generators, etc., please connect them to the main Inverter.
- Remote Shutdown/NS Protection function: Please connect the communication cable to the main Inverter. Rapid Shutdown (RSD: Rapid Shutdown) function: Please connect the communication cable to each Inverter separately. If you need to use both the Rapid Shutdown and Remote Shutdown/NS Protection functions simultaneously, please contact the after-sales service center.
- In a parallel system, if you need to disconnect any port circuit breaker of a certain Inverter, please simultaneously disconnect the other port circuit breakers of this Inverter; otherwise, it may cause abnormal system operation.
- In a parallel system, each Inverter needs to be installed with a WiFi/LAN Kit-20 or 4G Kit-CN-G20.

NOTICE

- When using the battery non-busbar connection mode in a parallel system:
 - The Inverter's "BAT connection mode" only supports "Independent connection".
 - Each battery interface of every Inverter needs to be connected to a battery system.
 - Different models of Goodwe batteries can be connected. For related wiring methods, please refer to the "[5.8.Connecting the Battery Cable\(Page 138\)](#)" chapter.
- If different models of Goodwe batteries exist in the parallel system, you need to configure the corresponding battery parameters for each Inverter separately via the App. For specific setup steps, please refer to the "[7.2.9.Setting Battery Function\(Page 283\)](#)" chapter.
- The Goodwe busbar box supports a maximum of 6 Inverters in parallel. If you require a 10-unit parallel system, please prepare your own busbar.
- When connecting a generator to a parallel system, the following requirements must be met:
 - The generator power must be greater than the total power of all loads on the BACKUP port.
 - The rated voltage of the generator busbar box must match the rated voltage of the Inverter's GEN port, and the insulation voltage of the busbar relative to the busbar box casing should be greater than DC 2120V; the rated current should be greater than 1.2 times the sum of the rated currents of all GEN ports in the parallel system, i.e., (Number of parallel units × Single unit GEN port rated current × 1.2).
- The following diagram focuses on wiring related to parallel systems. For wiring requirements of other ports, please refer to the single-unit system.

In a parallel system scenario, the inverter connected to the meter is the master inverter, and the others are slave inverters.

The master inverter needs to be set as the host via the App 'Parallel System Settings'. For specific settings, please refer to [7.2.5.Setting up the RS485 Parallel System\(Page 240\)](#).

General Scenario

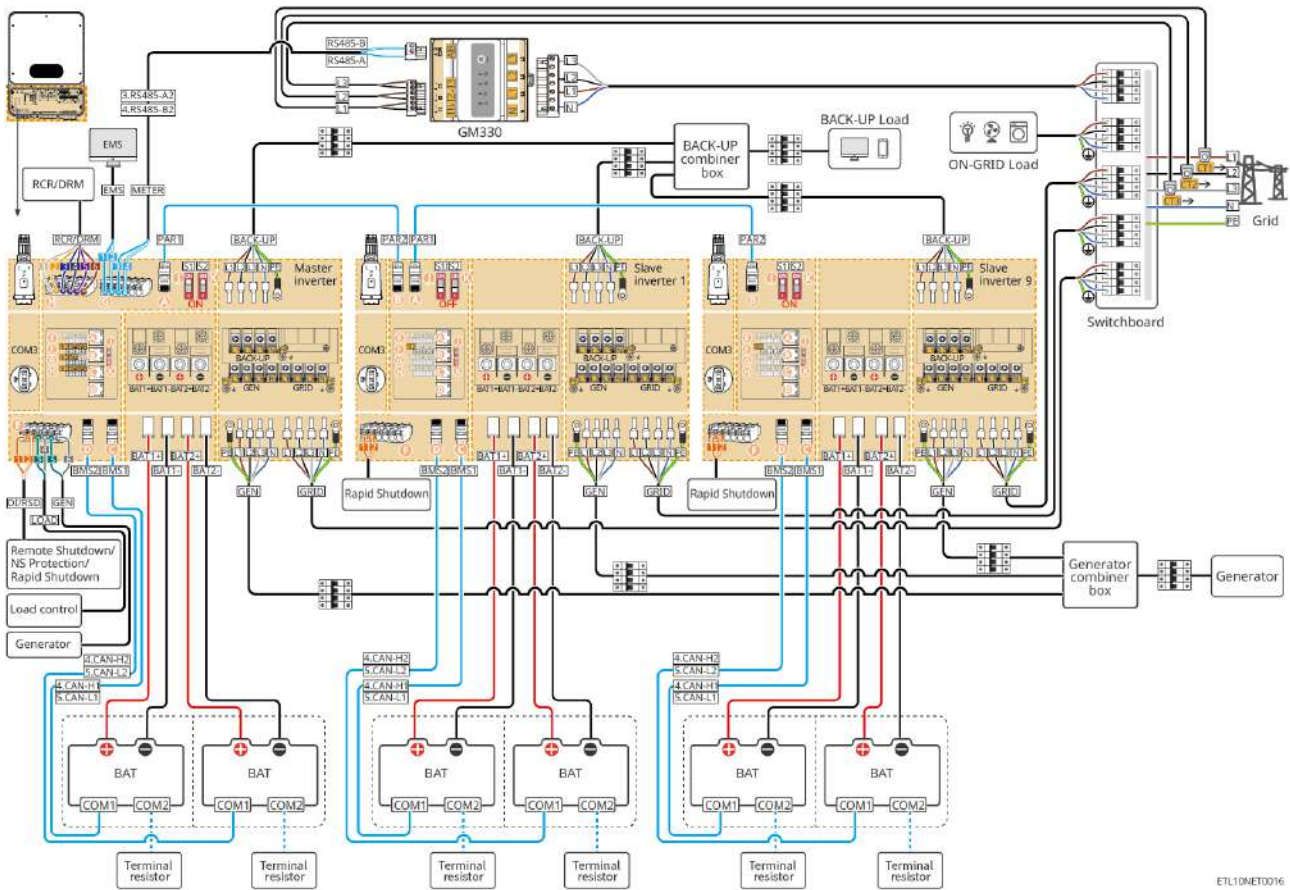

ETL10NET0016

In the general scenario of the parallel system, for the battery busbar wiring method, please refer to the battery busbar wiring method in the coupling scenario.

Coupling Scenario

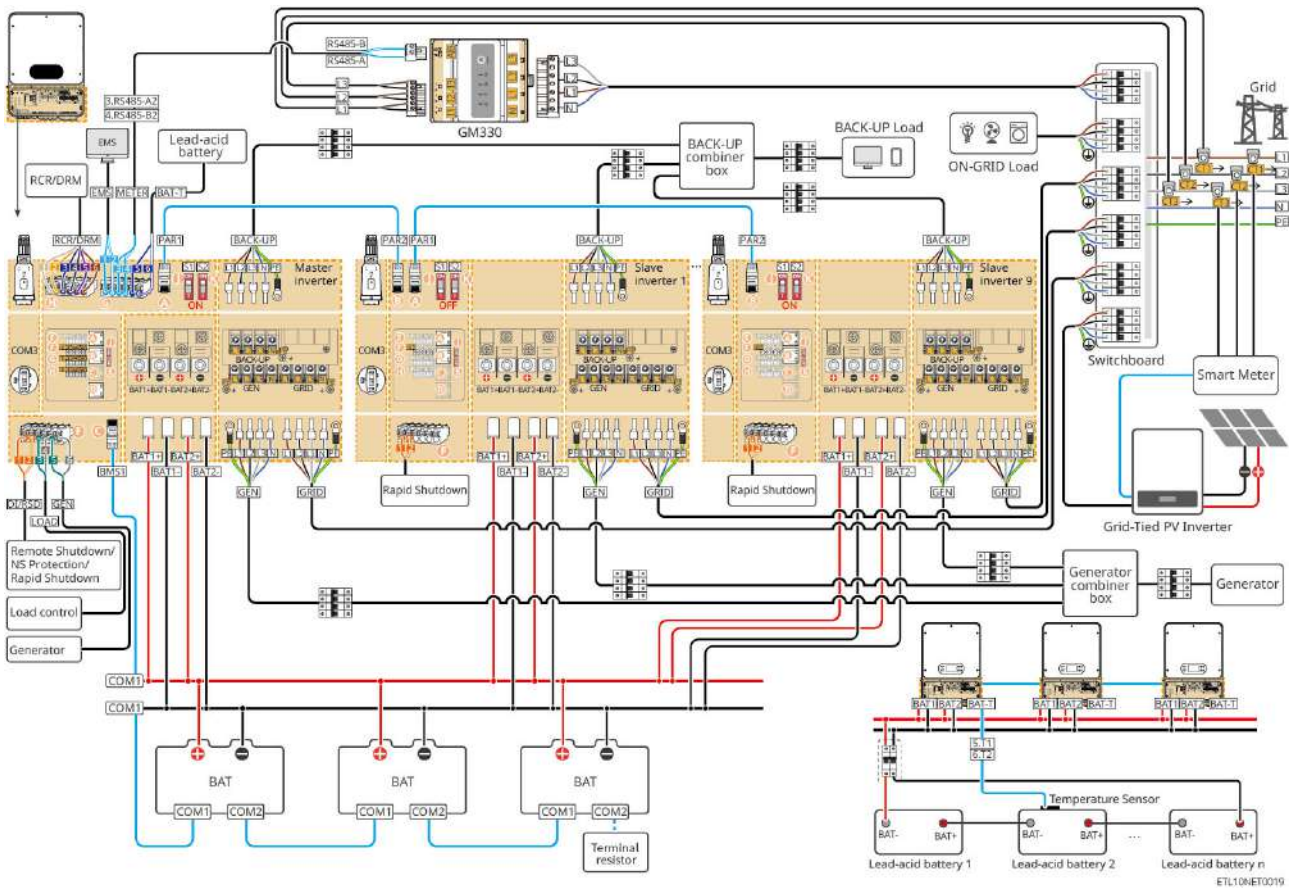

In the coupling scenario of the parallel system, for the battery daisy-chain wiring method, please refer to the battery daisy-chain wiring method in the general scenario.

5.3 Preparing Materials



- Do not connect loads between the inverter and the AC switch directly connected to the inverter.
- Each inverter must be equipped with an AC output circuit breaker. Multiple inverters must not be connected to the same AC circuit breaker simultaneously.
- To ensure the inverter can be safely disconnected from the grid in case of an abnormality, please connect an AC circuit breaker on the AC side of the inverter. Select an appropriate AC circuit breaker according to local regulations.
- When the inverter is powered on, the BACK-UP AC port is live. If maintenance is required on the BACK-UP Loads, power down the inverter first, otherwise electric shock may occur.
- For cables used within the same system, it is recommended that the following aspects are consistent: conductor material, cross-sectional area, length, etc.
 - BACK-UP AC cable for each inverter
 - ON-GRID AC cable for each inverter
 - Power cable between the inverter and the battery
 - Power cable between batteries
 - Power cable between the inverter and the busbar
 - Power cable between the battery and the busbar

5.3.1 Preparing Breakers

No.	breaker	Recommended Specifications	Procurement Method	Remarks
1	<ul style="list-style-type: none"> • ON-GRID breaker • BACK-UP Loads breaker 	<p>Recommendations for partial backup scenarios are as follows:</p> <ul style="list-style-type: none"> • Nominal Voltage $\geq 230V_{ac}$, Rated Current requirements are as follows: <ul style="list-style-type: none"> ◦ GW5K-ET-L-G10, GW6K-ET-L-G10: Rated Current $\geq 20A$ ◦ GW8K-ET-L-G10, GW10K-ET-L-G10: Rated Current $\geq 32A$ ◦ GW12K-ET-L-G10, GW15K-ET-L-G10, GW20K-ET-L-G10: Rated Current $\geq 63A$ • Nominal Voltage $\geq 127V_{ac}$, Rated Current requirements are as follows: <ul style="list-style-type: none"> ◦ GW12K-ET-L-G10: Rated Current $\geq 63A$ 	Self-provide d	During actual selection, you can also choose a breaker that meets local installation regulations based on the actual working current.
2	<ul style="list-style-type: none"> • ON-GRID breaker • BACK-UP Loads breaker 	<p>Recommendations for whole-house backup scenarios are as follows:</p> <ul style="list-style-type: none"> • Nominal Voltage $\geq 230V_{ac}$, Rated Current requirements are as follows: <ul style="list-style-type: none"> ◦ GW5K-ET-L-G10, GW6K-ET-L-G10, GW8K-ET-L-G10, GW10K-ET-L-G10, GW12K-ET-L-G10, GW15K-ET-L-G10, GW20K-ET-L-G10: Rated Current $\geq 100A$ • Nominal Voltage $\geq 127V_{ac}$, Rated Current requirements are as follows: <ul style="list-style-type: none"> ◦ GW12K-ET-L-G10: Rated Current $\geq 100A$ 	Self-provide d	

No.	breaker	Recommended Specifications	Procurement Method	Remarks
3	GEN breaker	Nominal Voltage $\geq 230V_{ac}$ Rated Current requirements are as follows: 63A for all power ranges	Self-provide d	
4	Battery Switch	Select according to local laws and regulations <ul style="list-style-type: none"> • Nominal Voltage $\geq 60V_{dc}$, Rated Current requirements are as follows: <ul style="list-style-type: none"> ◦ GW5K-ET-L-G10: Rated Current $\geq 125A$ ◦ GW6K-ET-L-G10: Rated Current $\geq 160A$ ◦ GW8K-ET-L-G10: Rated Current $\geq 200A$ ◦ GW10K-ET-L-G10: Rated Current $\geq 250A$ ◦ GW12K-ET-L-G10: Rated Current $\geq 250A$ ◦ GW15K-ET-L-G10: Rated Current $\geq 200A \times 2$ ◦ GW20K-ET-L-G10: Rated Current $\geq 250A \times 2$ • Nominal Voltage $\geq 60V_{dc}$, Rated Current requirements are as follows: <ul style="list-style-type: none"> ◦ GW12K-ET-LL-G10: Rated Current $\geq 250A$ 	Self-provide d	
5	RCD	Select according to local laws and regulations <ul style="list-style-type: none"> • Type A • ON-GRID side: 300mA • BACK-UP side: 30mA 	Self-provide d	-

5.3.2 Preparing Cables

No.	Cable	Recommended Specifications	Acquisition Method	Remarks
1	Inverter Protective Ground Cable	<ul style="list-style-type: none"> • Single-core outdoor copper cable • Conductor cross-sectional area: $S=16\text{mm}^2$ • Cable outer diameter: 7.5mm-9.0mm 	User-provided	-
2	Battery Protective Ground Cable	<ul style="list-style-type: none"> • Single-core outdoor copper cable • Conductor cross-sectional area: <ul style="list-style-type: none"> ◦ LX A5.0-30: 10mm^2 ◦ LX U5.0-30: 10mm^2 ◦ GW14.3-BAT-LV-G10: 10mm^2 ◦ GW16.1-BAT-LV-G10: 10mm^2 	<ul style="list-style-type: none"> • User-provided • LX A5.0-30: Available via accessories (optional) • GW14.3-BAT-LV-G10: For some units, ground cable shipped with battery accessories • GW16.1-BAT-LV-G10: standard-equipped 	-
3	PV DC Cable	<ul style="list-style-type: none"> • Industry-standard outdoor PV cable • Conductor cross-sectional area: $4\text{-}6\text{mm}^2$ • Cable outer diameter: 5.9mm-8.8mm 	User-provided	-

No.	Cable	Recommended Specifications	Acquisition Method	Remarks
4	Battery DC Cable	<ul style="list-style-type: none"> • Single-core outdoor copper cable • Inverter battery port wiring requirements: <ul style="list-style-type: none"> ◦ Conductor cross-sectional area: 70mm² ◦ Cable outer diameter: 15.7mm-16.7mm • Cable requirements between battery and busbar: <ul style="list-style-type: none"> ◦ LX A5.0-30, conductor cross-sectional area: 50mm² ◦ LX U5.0-30, conductor cross-sectional area: 25mm² ◦ GW14.3-BAT-LV-G10, conductor cross-sectional area: 70mm² ◦ GW16.1-BAT-LV-G10, conductor cross-sectional area: 50mm² • Cable requirements between battery and battery: <ul style="list-style-type: none"> ◦ LX A5.0-30, conductor cross-sectional area: 50mm² ◦ LX U5.0-30, conductor cross-sectional area: 25mm² ◦ GW14.3-BAT-LV-G10, 	<ul style="list-style-type: none"> • User-provided • LX U5.0-30: Available for purchase from GoodWe • LX A5.0-30: Available via accessories (optional) • GW14.3-BAT-LV-G10: For some units, battery DC cable shipped with battery accessories • GW16.1-BAT-LV-G10: <ul style="list-style-type: none"> ◦ DC cable between inverter and battery: standard-equipped ◦ DC cable between batteries: Available for purchase from GoodWe 	-

No.	Cable	Recommended Specifications	Acquisition Method	Remarks
		<p>conductor cross-sectional area: 70mm²</p> <ul style="list-style-type: none"> ◦ GW16.1-BAT-LV-G10, conductor cross-sectional area: 50mm² 		
5	AC Cable	<ul style="list-style-type: none"> • Inverter AC input/output cable (BACK-UP/ON-GRID): <ul style="list-style-type: none"> ◦ Conductor cross-sectional area: 16mm² ◦ Multi-core outdoor copper cable outer diameter: 25-32mm • Generator power cable (GEN): <ul style="list-style-type: none"> ◦ Conductor cross-sectional area: 10mm² ◦ Multi-core outdoor copper cable outer diameter: 18mm-22mm 	User-provided	For cable sizing, you can also choose a cable diameter that meets local installation regulations based on the actual working current.
6	Smart Meter Power Cable	<ul style="list-style-type: none"> • Outdoor copper cable • Conductor cross-sectional area: 1mm² 	User-provided	-

No.	Cable	Recommended Specifications	Acquisition Method	Remarks
7	Battery BMS Communication cable	Custom communication cable, default length is 3m	Shipped with the inverter	If self-provided, Recommended: CAT 5E or higher standard Ethernet cable and RJ45 connector

No.	Cable	Recommended Specifications	Acquisition Method	Remarks
8	Battery Communication cable	For communication between the combiner box and battery, and between batteries, use CAT 5E or higher standard shielded Ethernet cable and shielded RJ45 connector.	<ul style="list-style-type: none"> • User-provided • LX A5.0-30: Available via accessories (optional) • GW14.3-BAT-LV-G10: <ul style="list-style-type: none"> ◦ Communication cable between inverter and battery: standard-equipped for some ◦ Communication cable between batteries: User-provided, cable length $\leq 2\text{m}$ • GW16.1-BAT-LV-G10: <ul style="list-style-type: none"> ◦ Communication cable between inverter and battery: standard-equipped ◦ Communication cable between batteries: User-provided, cable length $\leq 1\text{m}$ 	-

No.	Cable	Recommended Specifications	Acquisition Method	Remarks
9	WiFi/LAN Kit-20 Communication cable	CAT 5E or higher standard shielded Ethernet cable and shielded RJ45 connector	User-provided	-
10	CT Communication cable	<ul style="list-style-type: none"> • Shielded cable meeting local standards • Conductor cross-sectional area: 0.2mm²-0.4mm² • Cable outer diameter: 5mm-8mm 	User-provided	-
11	EMS RS485 Communication cable	<ul style="list-style-type: none"> • Shielded twisted pair • Conductor cross-sectional area: 0.2mm²-0.4mm² 	User-provided	-
12	Meter RS485 Communication cable			
13	Load Control and Generator Control Communication cable		User-provided	-

No.	Cable	Recommended Specifications	Acquisition Method	Remarks
14	Remote Shutdown Communication cable Rapid Shutdown Communication cable NS Protection Communication cable	<ul style="list-style-type: none"> • Shielded cable meeting local standards • Conductor cross-sectional area: 0.2mm²-0.4mm² • Cable outer diameter: 5mm-8mm 		-
15	RCR/DRED Signal Cable			-
16	Lead-Acid Battery Temperature Sensor Cable		User-provided	China only
16	Inverter Parallel Communication Cable	<ul style="list-style-type: none"> • RJ45 connector • CAT 5E or higher straight-through Ethernet cable <ul style="list-style-type: none"> ◦ CAT 5E or CAT 6E recommended length not exceeding 5 meters ◦ CAT 7E recommended length not exceeding 10 meters 	User-provided	-

5.4 Removing the Inverter Enclosure Lower Cover

Remove the inverter enclosure lower cover:

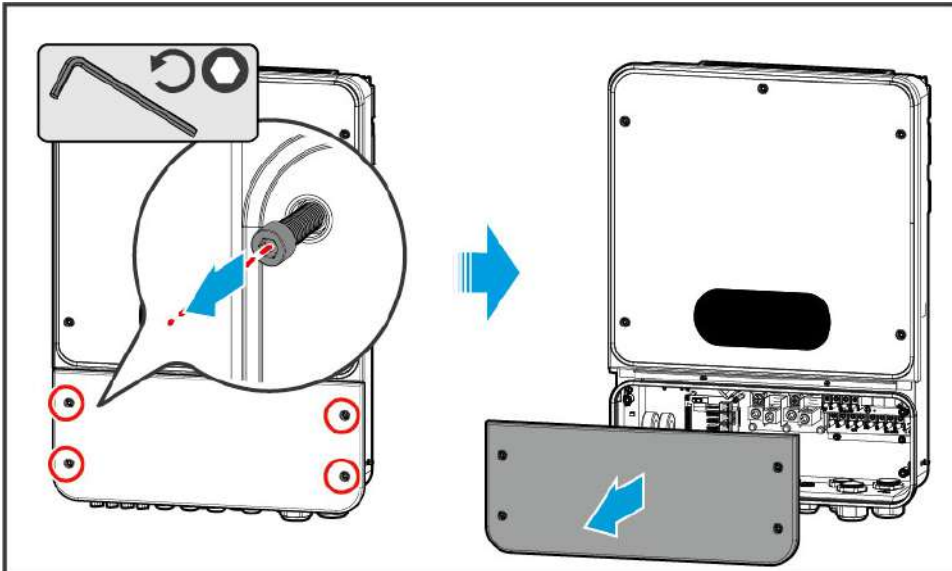

ETL10INT0003

(Optional) Gland nut unlocking tool usage:

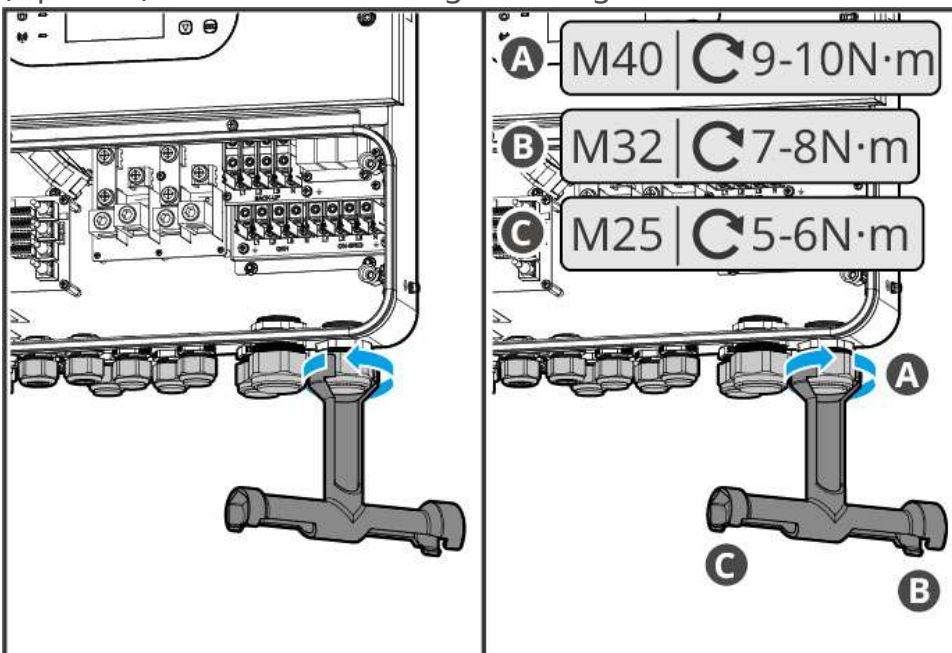

ETL10INT0008

5.5 Connecting the PE cable

!WARNING

- The protective grounding of the chassis cannot replace the protective ground wire of the AC output port. When wiring, ensure that the protective ground wires at both locations are reliably connected.
- To improve the corrosion resistance of the terminals, it is recommended to apply silicone or paint on the exterior of the grounding terminals for protection after the protective ground wire connection is installed.
- When installing the equipment, the protective ground wire must be installed first; when removing the equipment, the protective ground wire must be removed last.

NOTICE

GW14.3-BAT-LV-G10:

- If the battery grounding cable is provided in the packaging box, use this cable directly without any crimping operation.
- If the battery grounding cable is not provided in the packaging box, follow the steps below to make the cable.

Inverter

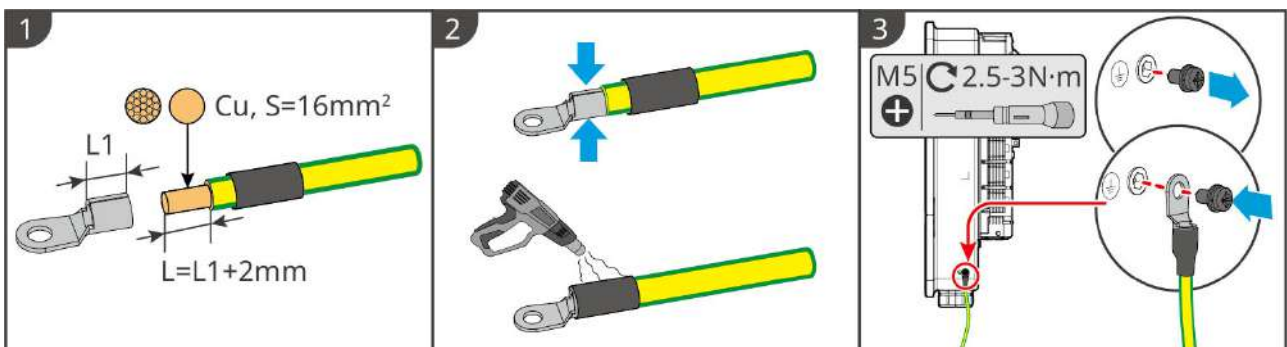

Battery (GW14.3-BAT-LV-G10)

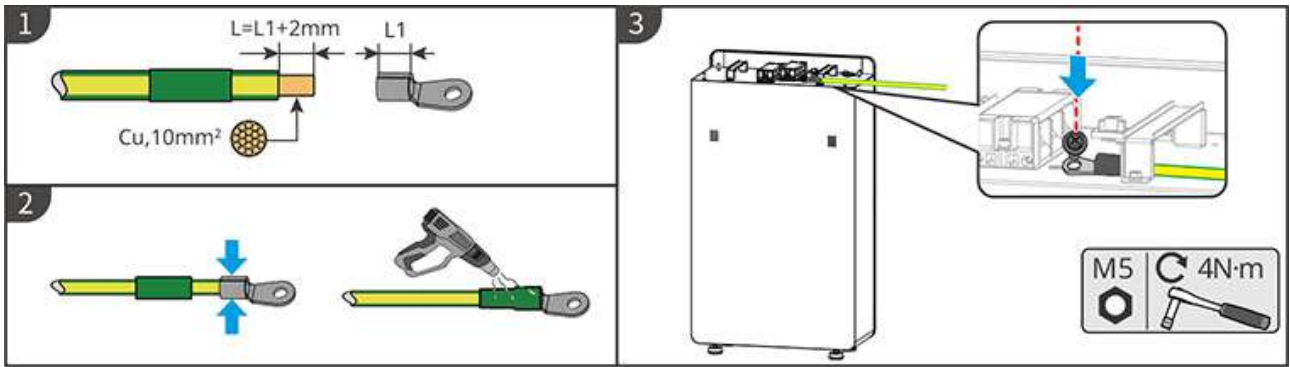

LXA10ELC0014

Battery (LX A5.0-30)

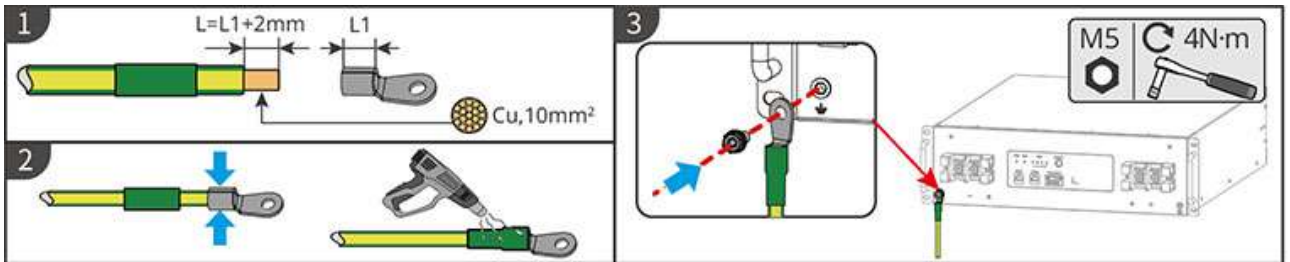

LXA30ELC0001

Battery (LX U5.0-30)

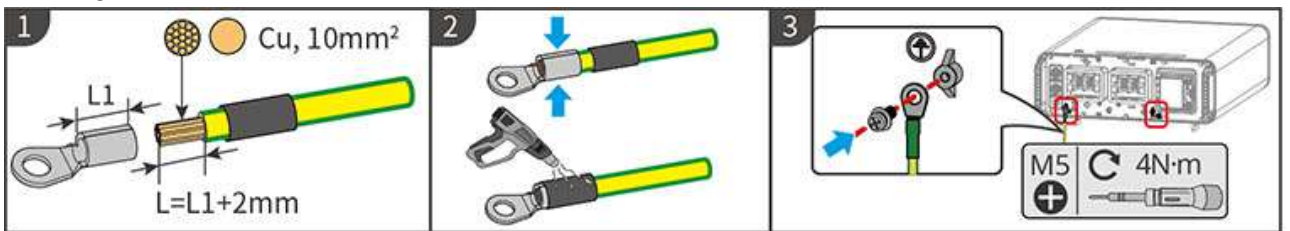

LXU30ELC0001

GW16.1-BAT-LV-G10

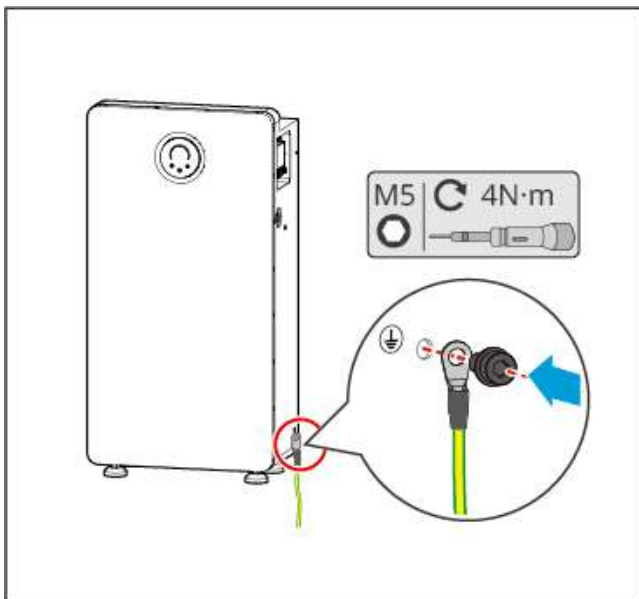

LXA40ELC0006

5.6 Connecting the AC Cable

WARNING

- The inverter integrates a Residual Current Monitoring Unit (RCMU) internally to prevent residual current from exceeding the specified value. When the inverter detects leakage current greater than the allowable value, it will quickly disconnect from the grid.
- During wiring, ensure that the AC wires completely match the "BACK-UP", "GRID", "GEN", and grounding ports of the AC terminals. Incorrect cable connections may cause equipment damage.
- Please ensure that the wire cores are fully inserted into the terminal connection holes with no exposure.
- Please ensure that the insulation plate at the AC terminals is tightly secured and not loose.
- Ensure that the cable connections are tight; otherwise, during equipment operation, it may cause terminal overheating and equipment damage.

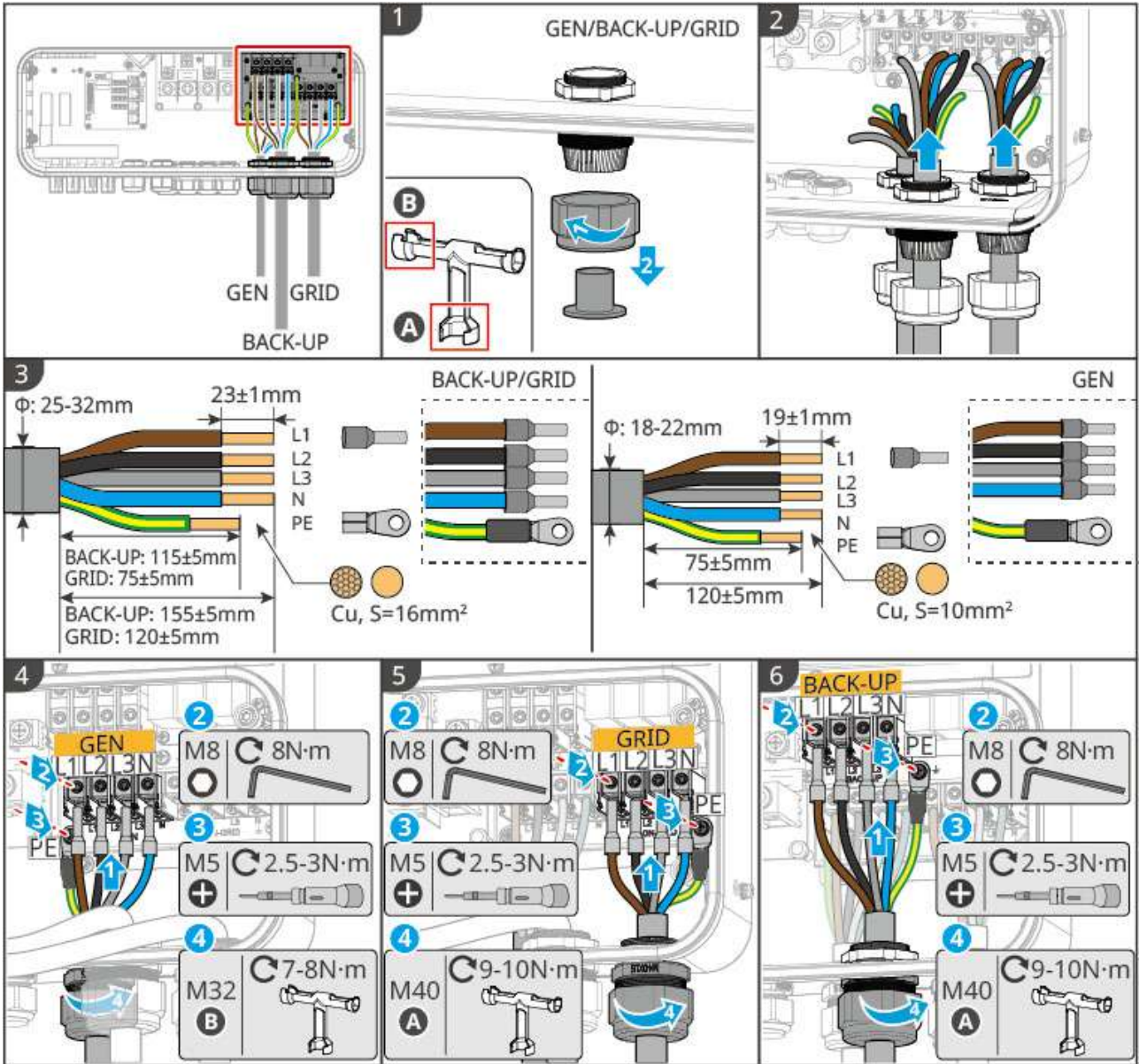

ETL10ELC0003

5.7 Connecting the PV Cable

DANGER

- Do not connect the same PV string to multiple inverters, otherwise it may cause inverter damage.
- Before connecting the PV string to the inverter, please confirm the following information, otherwise it may cause permanent damage to the inverter, and in severe cases, it may lead to fire causing personal injury and property loss.
 1. Please ensure that the maximum short-circuit current and maximum input voltage of each MPPT are within the allowable range of the inverter.
 2. Please ensure that the positive pole of the PV string is connected to the PV+ of the inverter, and the negative pole of the PV string is connected to the PV- of the inverter.

WARNING

- The PV string output does not support grounding. Before connecting the PV string to the inverter, ensure the minimum insulation resistance to ground of the PV string meets the minimum insulation impedance requirement ($R = \text{Max. Input Voltage} / 30\text{mA}$).
- After completing the DC cable connection, ensure the cable connections are tight and secure, with no looseness.
- Use a multimeter to measure the positive and negative poles of the DC cable to ensure correct polarity (no reverse connection) and that the voltage is within the allowable range.

NOTICE

The two PV strings within each MPPT circuit must use the same model, the same number of panels, the same tilt angle, and the same azimuth angle to ensure maximum efficiency.

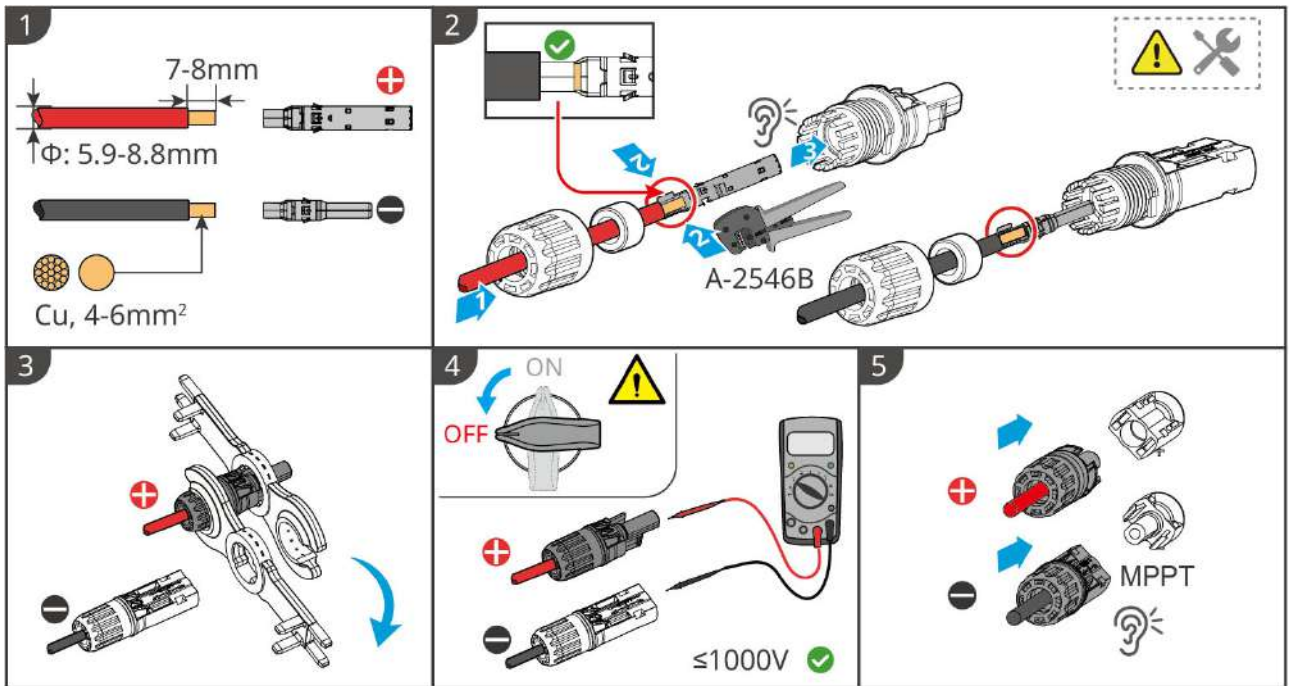

ETL10ELC002

If you need to remove the PV connector, please refer to the following steps for removal.

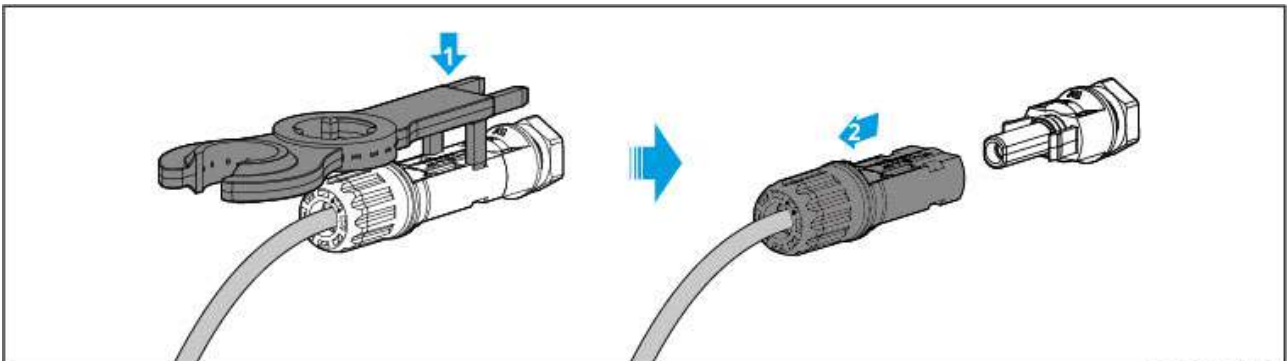

ESA20ELC0014

5.8 Connecting the Battery Cable

⚠ DANGER

- In a single-unit system, do not connect the same battery pack to multiple inverters, as this may cause inverter damage.
- Do not connect loads between the inverter and the battery.
- When connecting battery cables, use insulated tools to prevent accidental electric shock or battery short circuit.
- Ensure that the battery open-circuit voltage is within the allowable range of the inverter.
- Between the inverter and the battery, choose whether to configure a DC switch according to local laws and regulations.

NOTICE

- The battery system wiring diagram only provides a wiring illustration for some model devices. Please refer to the corresponding wiring guidance chapter for the actual device being used for connection.
- The two battery connection ports for GW15K-ET-L-G10 and GW20K-ET-L-G10 support connecting different models of lithium batteries; they do not support connecting lithium batteries and lead-acid batteries separately. When batteries are connected in parallel to the inverter, please connect the Battery Management System (BMS) communication cable to the inverter's BMS1 interface.
- When using the battery converged access mode in a parallel system, please connect the Battery Management System (BMS) communication cable to the master inverter's BMS1 interface.
- When using the battery non-converged access mode in a parallel system, a single inverter port supports a maximum of 15 batteries connected in parallel per cluster. If more batteries need to be connected in parallel per cluster, please contact GoodWe after-sales service center.
- The battery supports connection to GoodWe junction boxes and third-party busbars. If using a third-party busbar, please replace the terminal resistor with the black-appearance terminal resistor provided in the package.

Explanation of BMS Communication Connection Between Inverter and Battery:

Inverter Port	Connect to Battery Port	Port Definition	Description
BMS1/BMS2	COM1	4: CAN_H 5: CAN_L	<ul style="list-style-type: none"> CAN communication is used between the inverter and the battery. The inverter BMS port is connected to the battery COM1 port.

LX A5.0-30 Communication Port Definition

PIN	COM1	COM2	Description
1	-	·-	Reserved
2	-	-	
3	Parallel OUT+	Parallel OUT+	Parallel Communication Port
4	CAN_1H	CAN_1H	Connects to inverter communication or battery parallel cluster communication port
5	CAN_1L	CAN_1L	
6	Parallel OUT2+	Parallel OUT2+	Parallel Interlock Communication Port
7	-	-	Reserved
8	Parallel OUT-	Parallel OUT-	Parallel Communication Port

GW14.3-BAT-LV-G10, GW16.1-BAT-LV-G10 Communication Port Definition

PIN	COM1	COM2	Description
1	RS485A	RS485A	Reserved
2	RS485B-	RS485B-	
3	Parallel OUT+	Parallel OUT+	Parallel Communication Port
4	CAN_H	CAN_H	Connects to inverter communication or battery cluster communication port
5	CAN_L	CAN_L	
6	Parallel OUT2+	Parallel OUT2+	Parallel Communication Port
7	-	-	Reserved
8	Parallel OUT-	Parallel OUT-	Parallel Communication Port

LX U5.0-30 Communication Port Definition

PIN	COM1	COM2	Description
1	RS485A	RS485A	Reserved
2	RS485B-	RS485B-	
3	Parallel OUT+	Parallel OUT+	Parallel Communication Port
4	CAN_H	CAN_H	Connect to inverter communication or battery cluster parallel communication port
5	CAN_L	CAN_L	
6	Parallel OUT2+	Parallel OUT2+	Parallel Communication Port
7	-	-	Reserved
8	Parallel OUT-	Parallel OUT-	Parallel Communication Port

Battery System Wiring Diagram

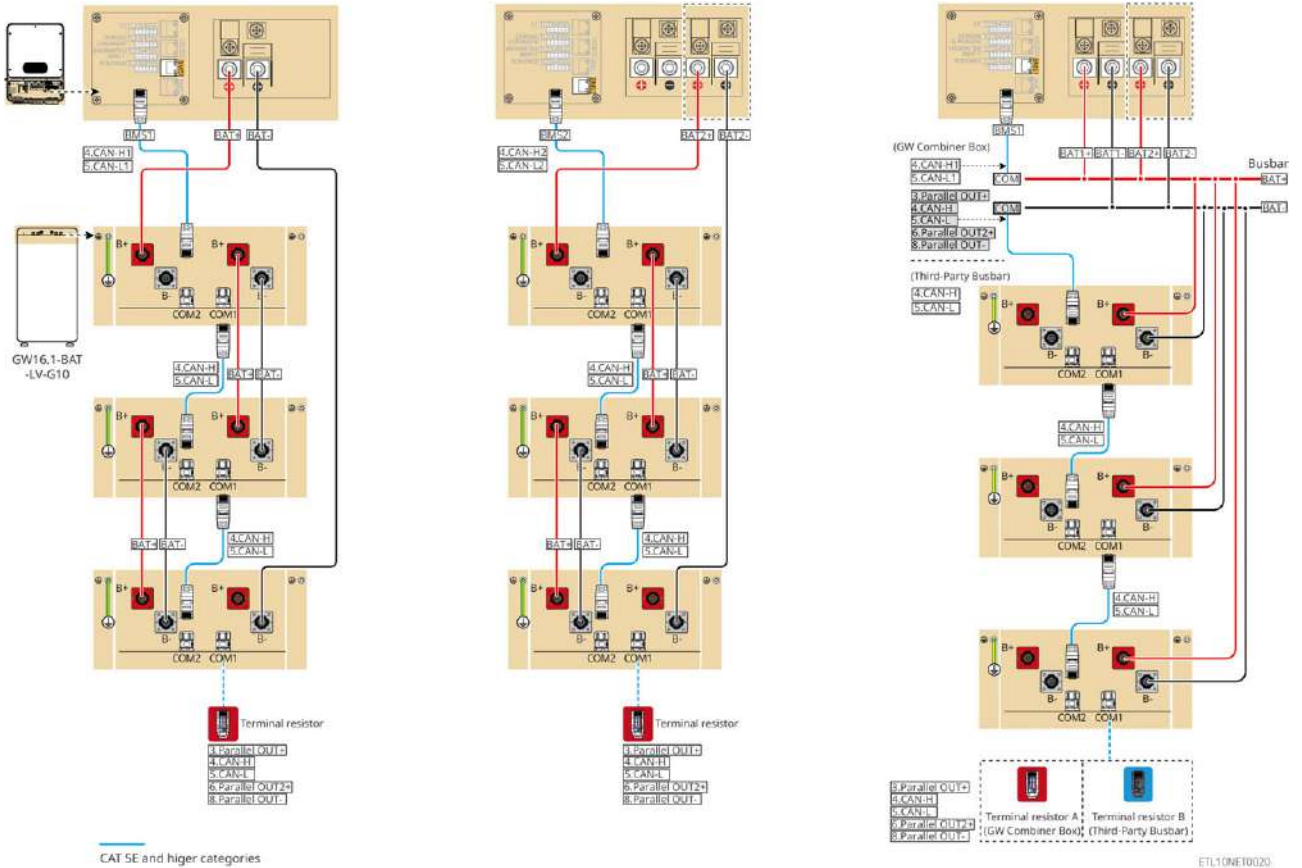

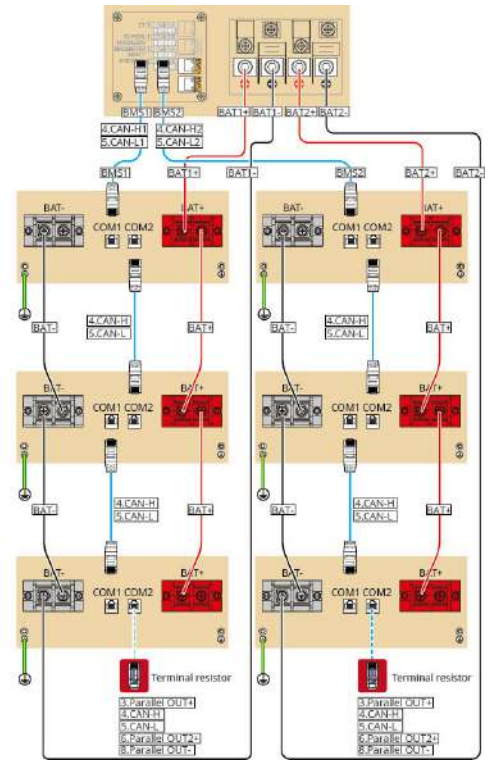
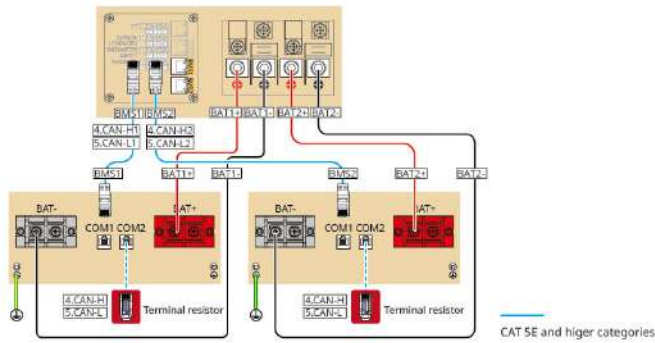
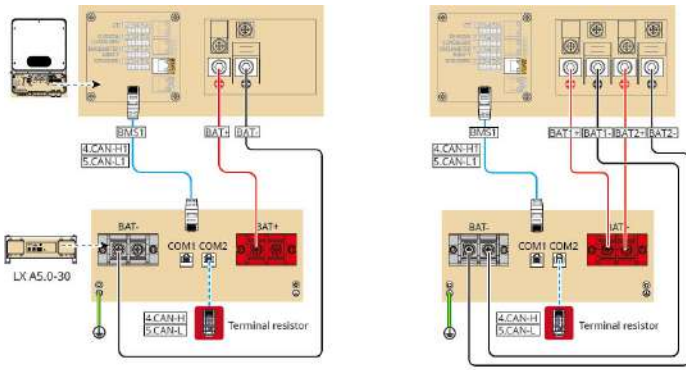

ETL10NET010

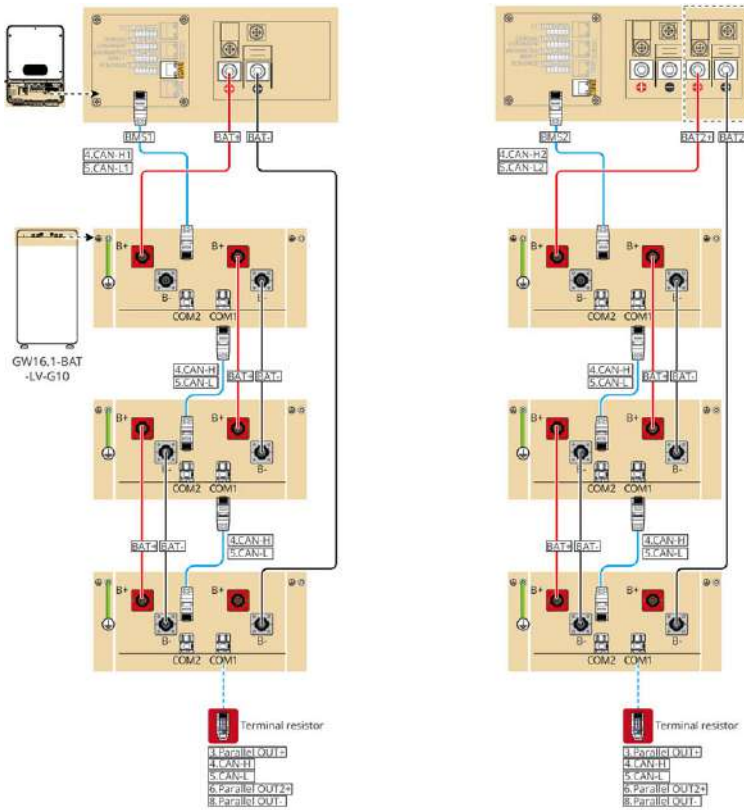

CAT 5E and higher categories

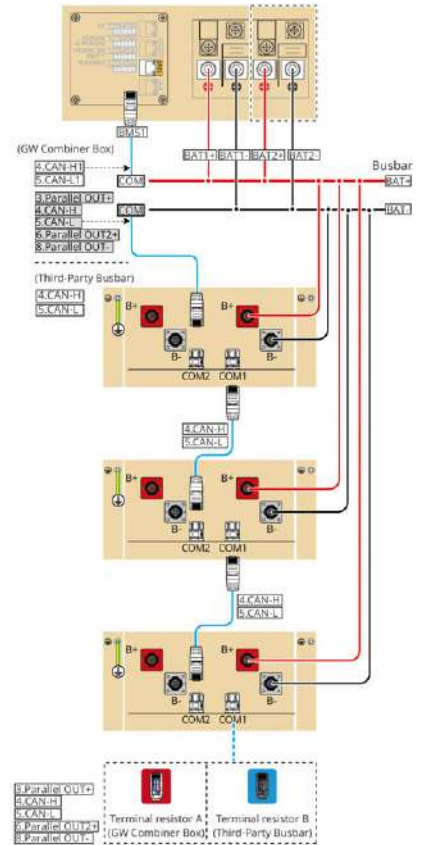

ETL10NET020

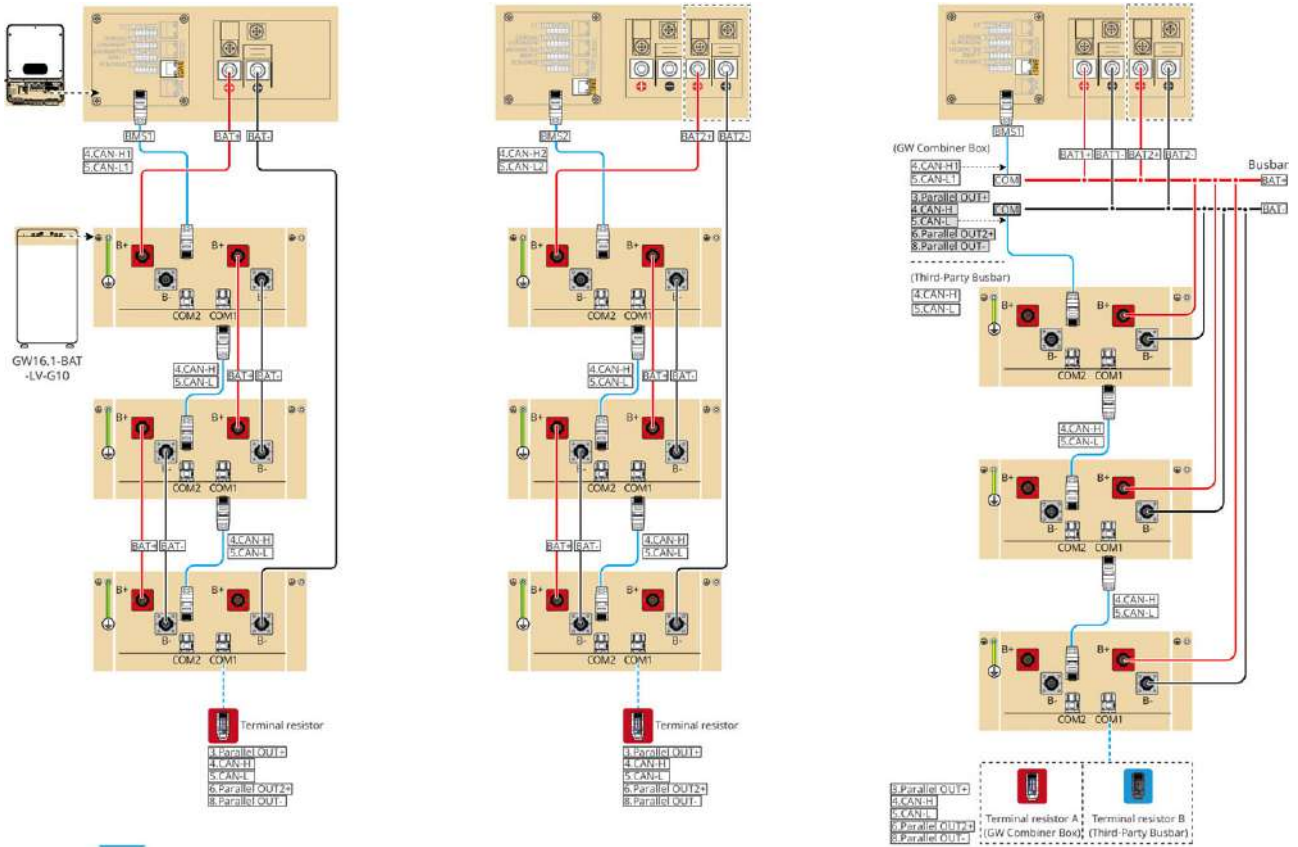

CAT 5E and higher categories

ETL10NET0020

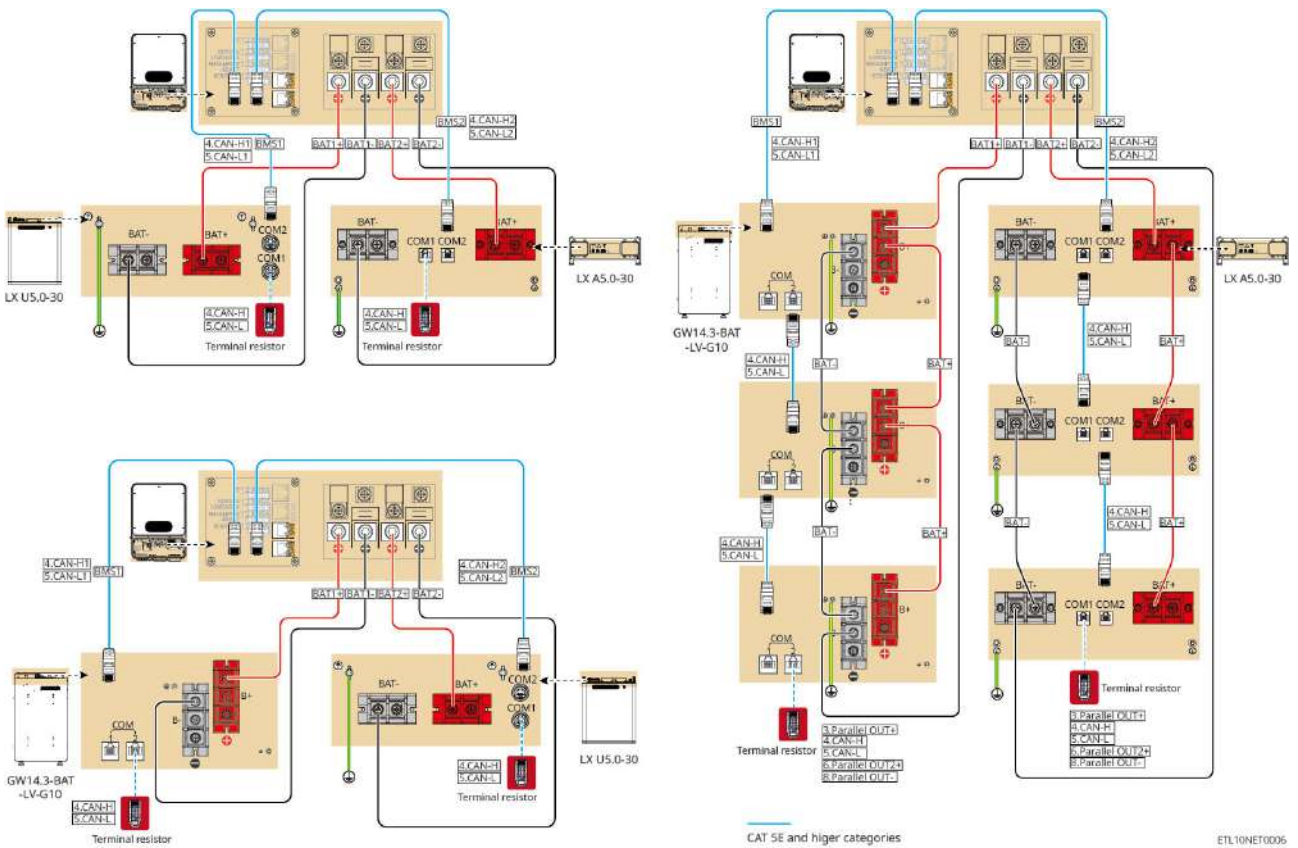

CAT 5E and higher categories

ETL10NET0006

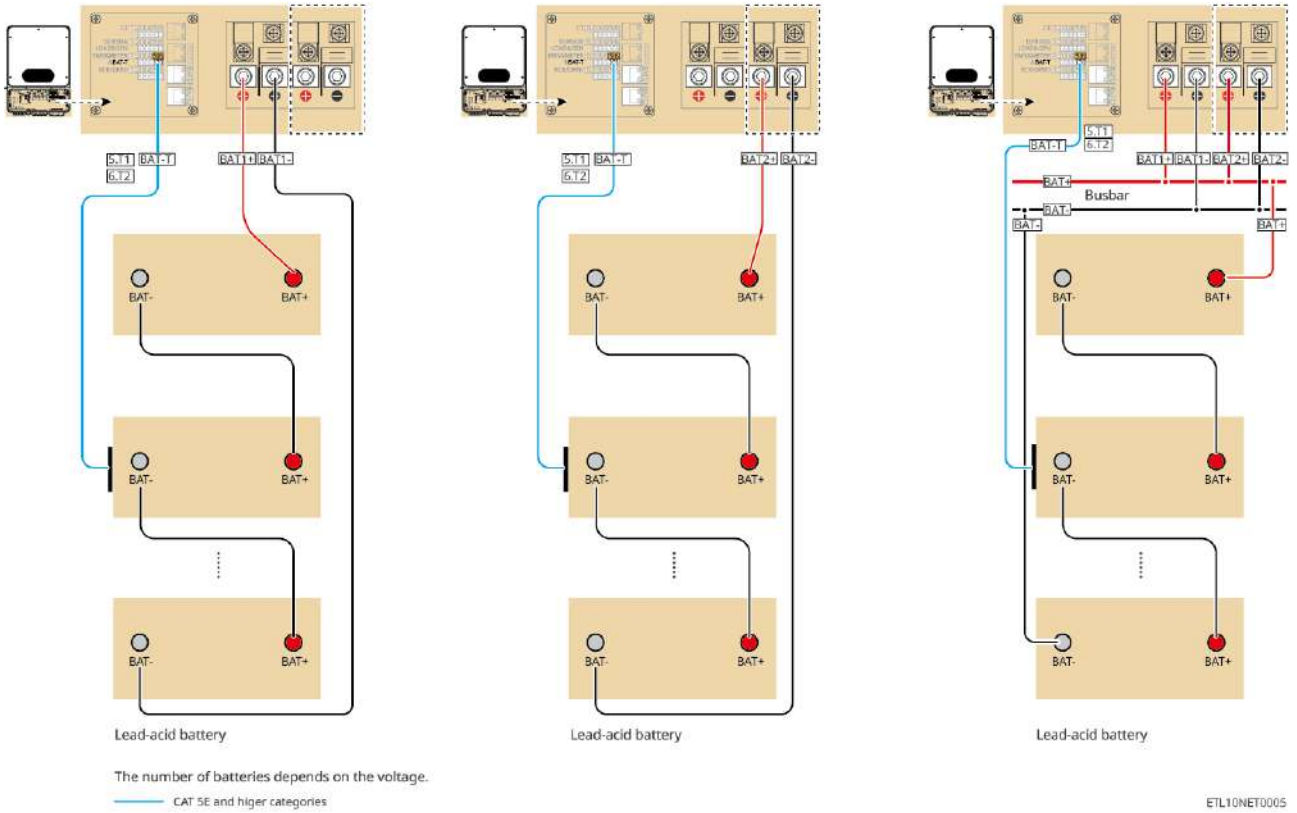

LX A5.0-30: Daisy-chain connection method

When a battery is connected to a single inverter with 1 output path

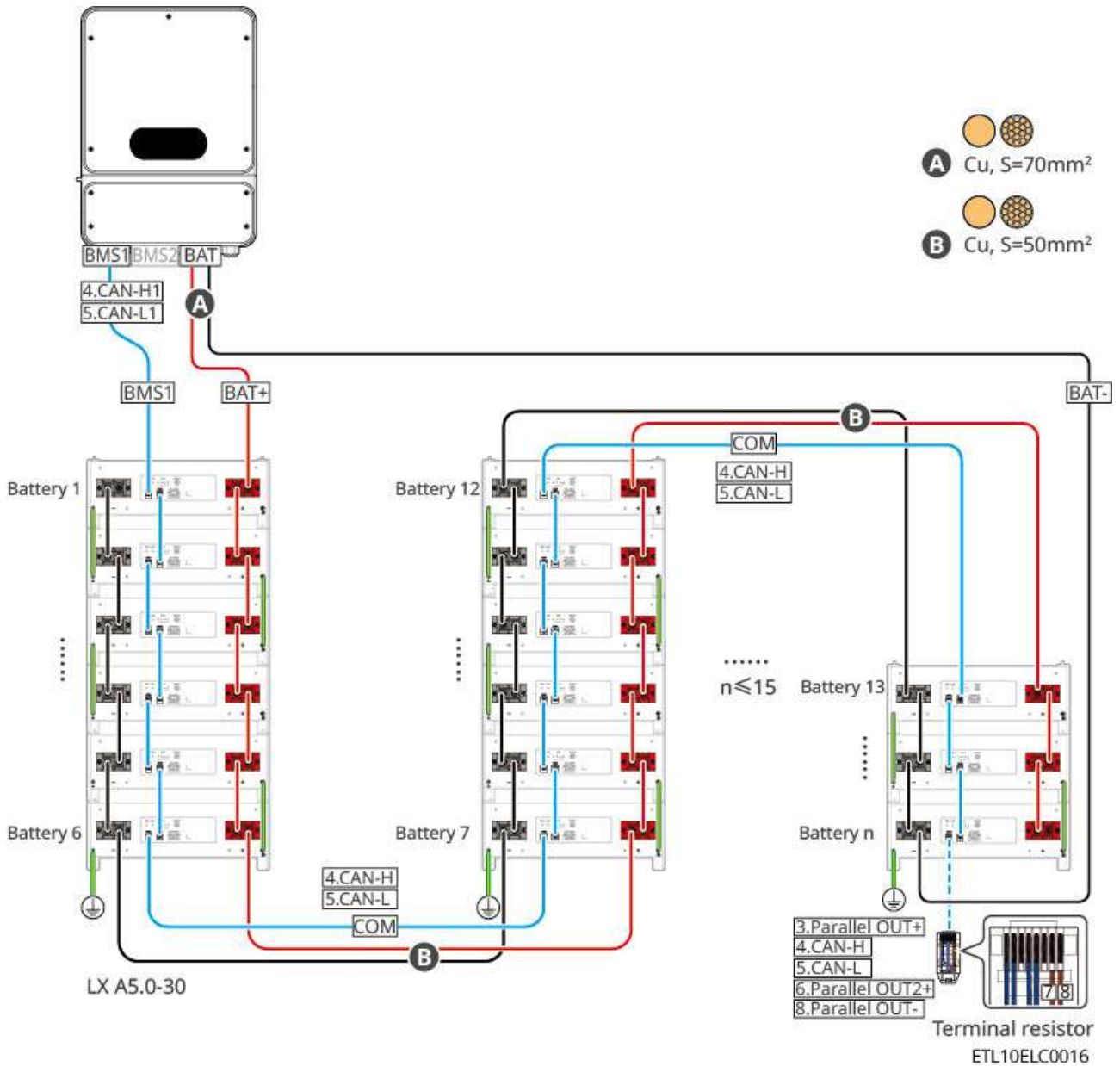

When a battery is connected to a single inverter with 2 output paths

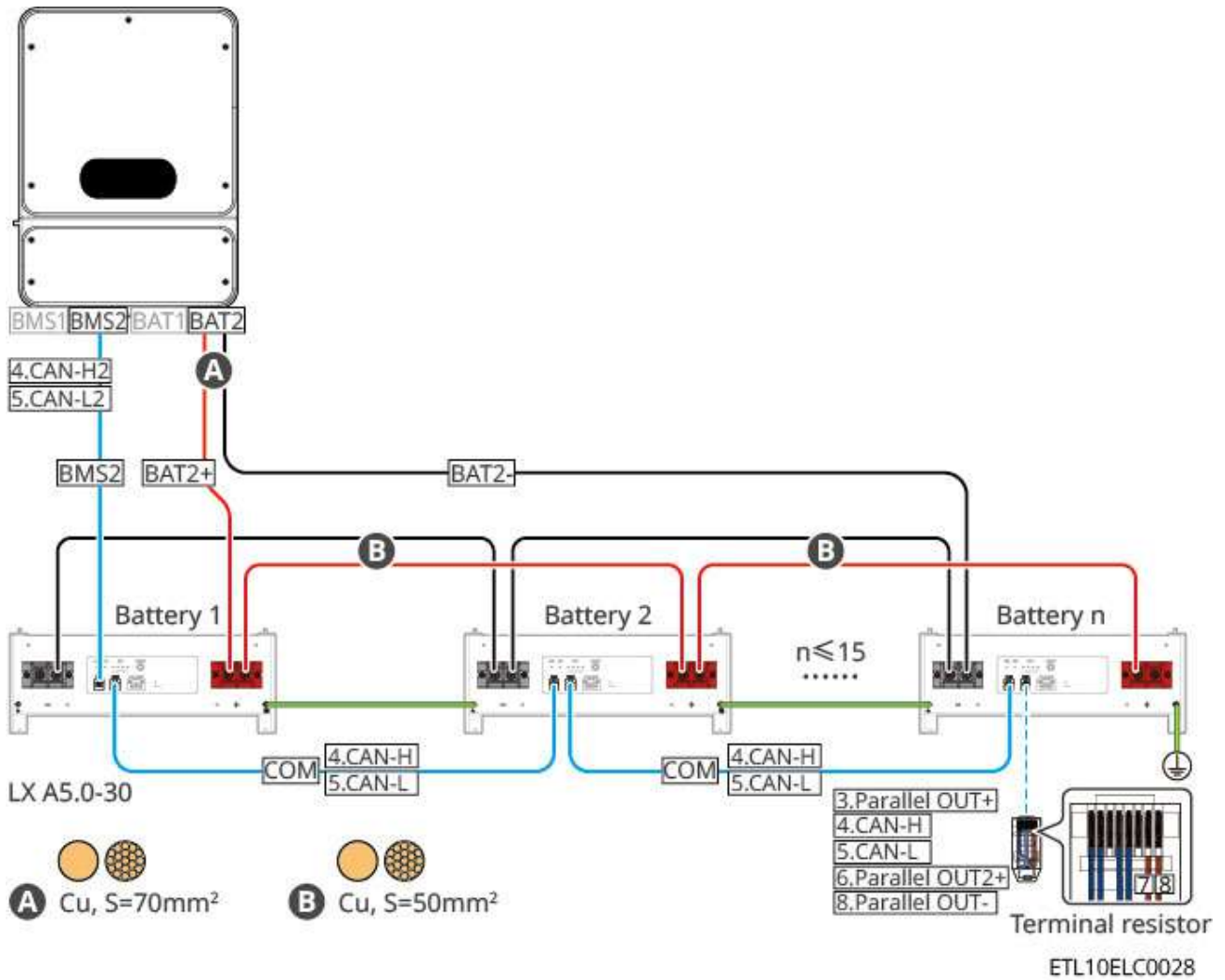

LX A5.0-30: When two battery paths are connected to a single inverter with 2 output paths, the wiring diagram is as follows:

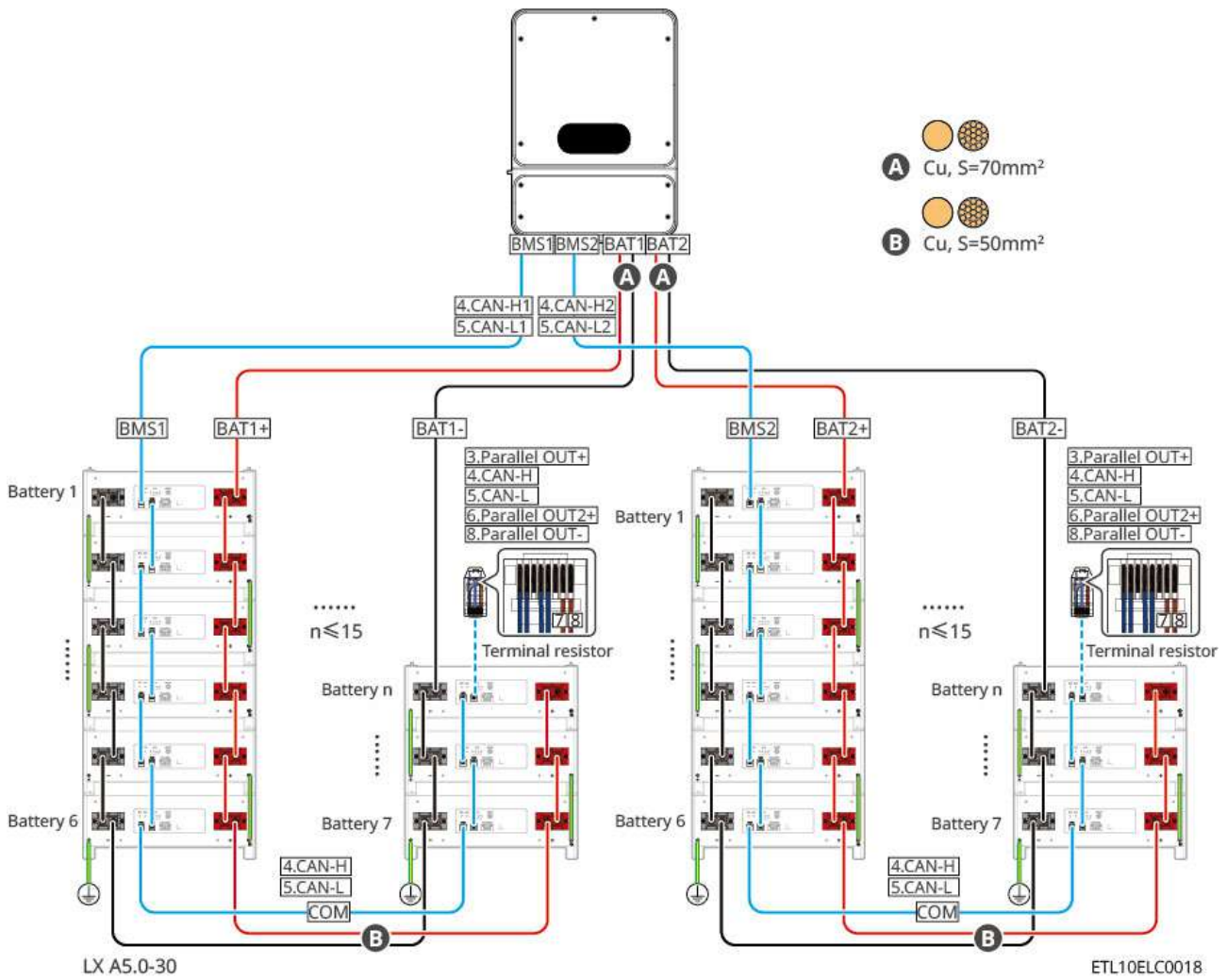

LXA5.0-30: Connection method with combiner box BCB-22-WW-0, the wiring diagram is as follows:

The battery system supports a maximum operating current of 720A, an operating power of 36kW, and can connect up to 6 inverters and 6 batteries.

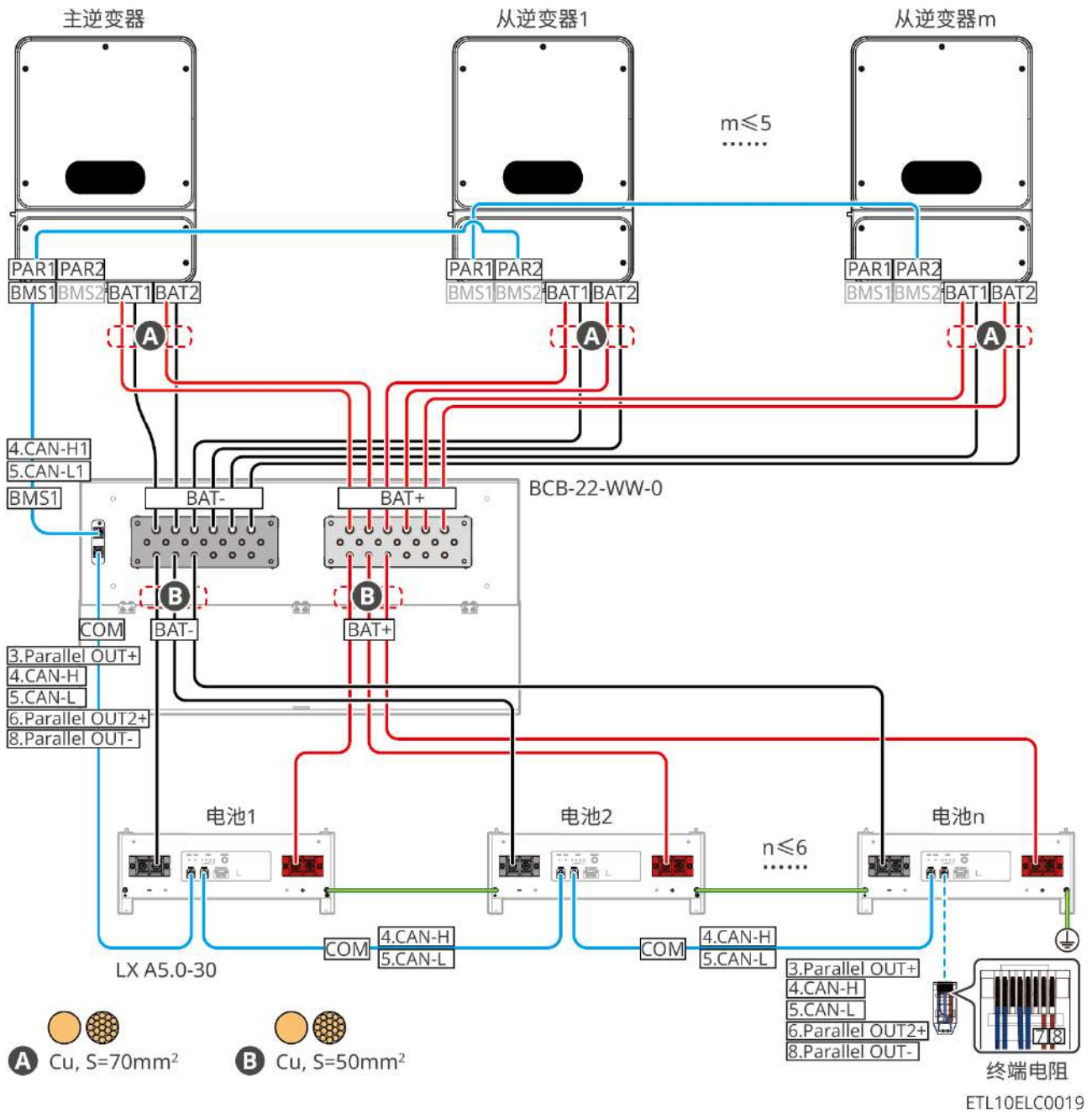

ETL10ELC0019

LX A5.0-30: Connection method with combiner box BCB-32-WW-0, the wiring diagram is as follows:

The battery system supports a maximum operating current of 720A, an operating power of 36kW, and can connect up to 6 inverters and 15 batteries.

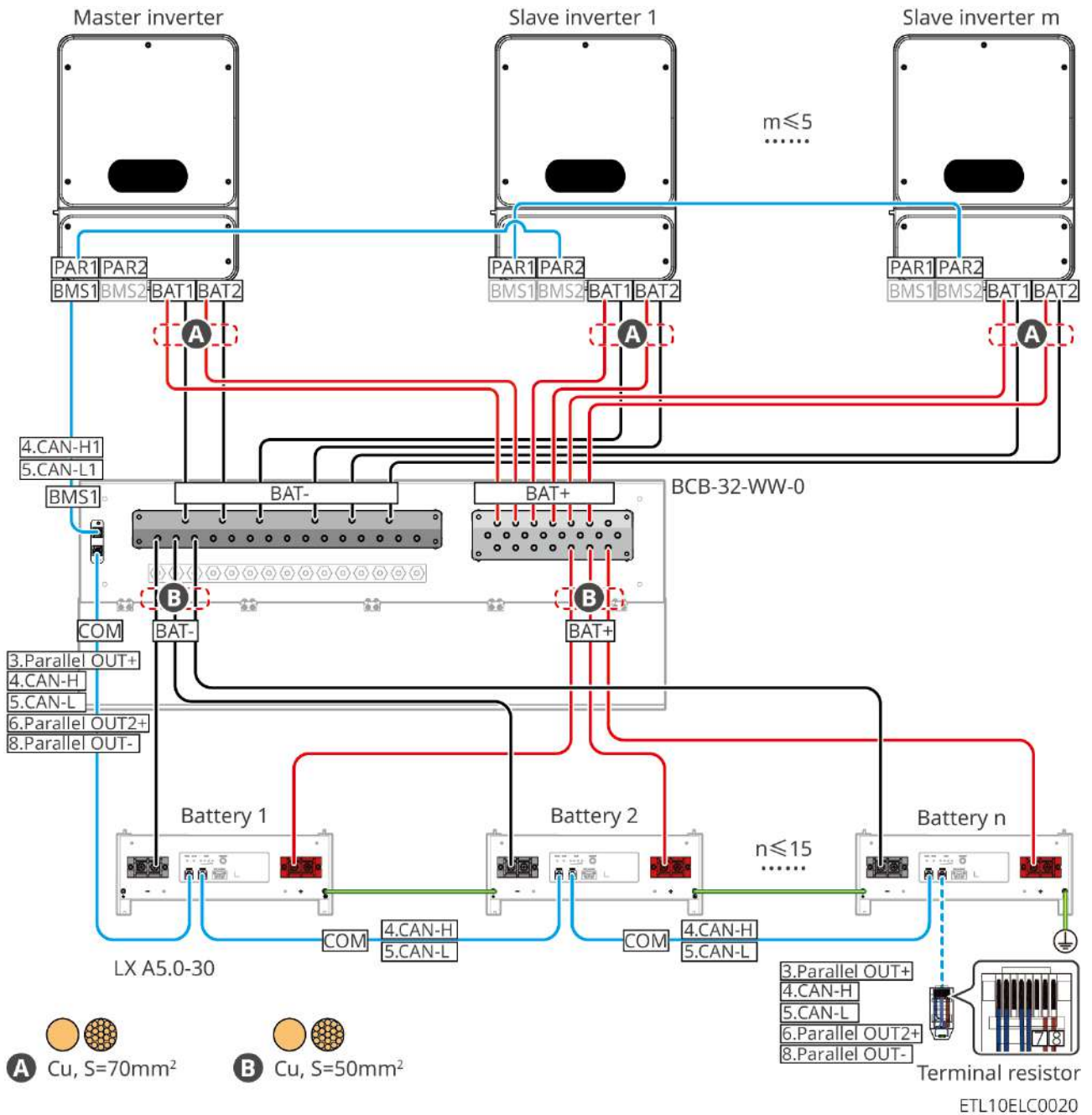

LXA5.0-30: Connection method with a third-party busbar, the wiring diagram is as follows:

The rated charging current for a single battery is 60A; the rated discharge current is 100A; the maximum charging current is 90A; the maximum discharge current is 150A. The system supports up to 30 parallel clusters.

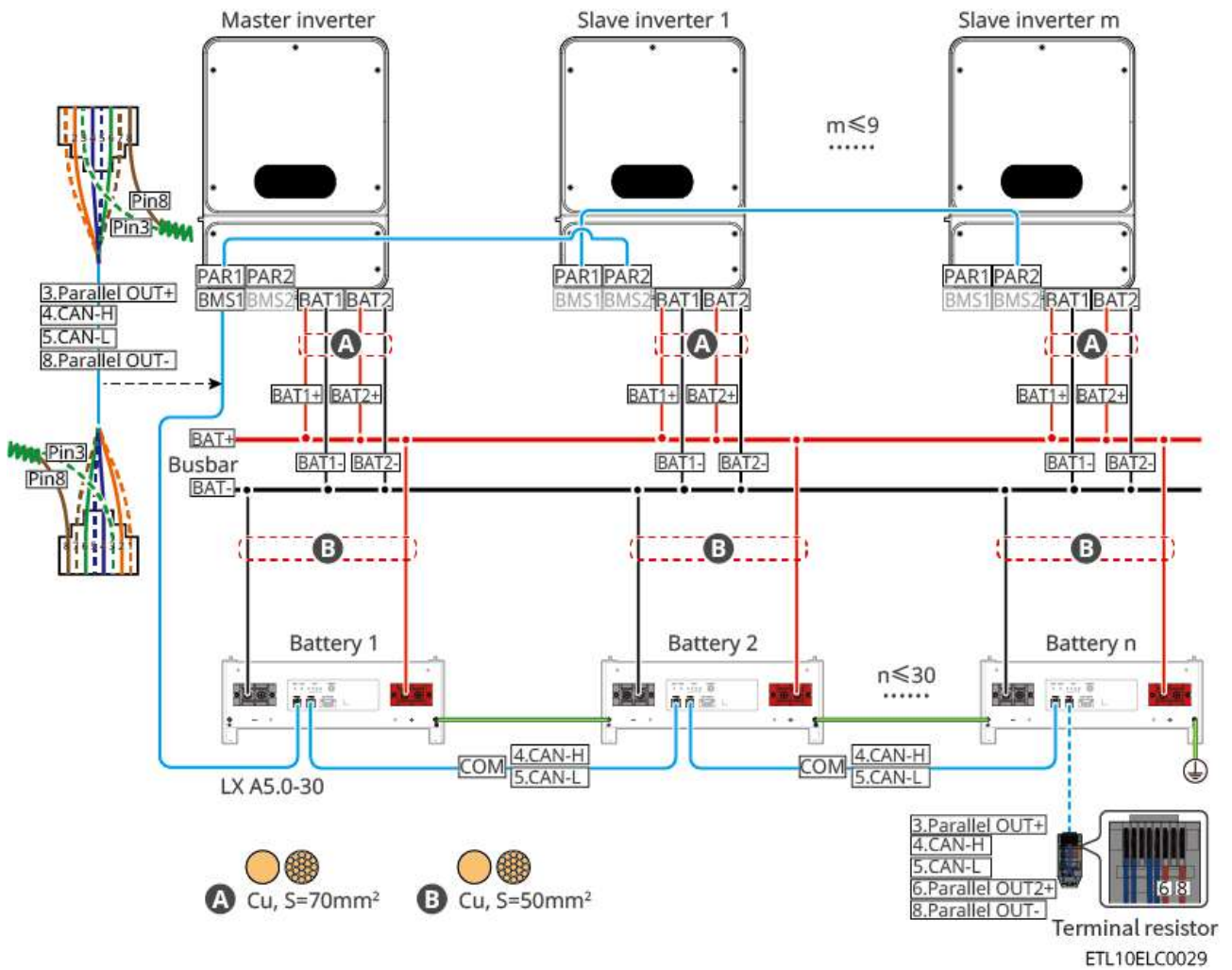

GW14.3-BAT-LV-G10: Daisy-chain connection method

When a battery is connected to a single inverter with 2 output paths

Type 1:

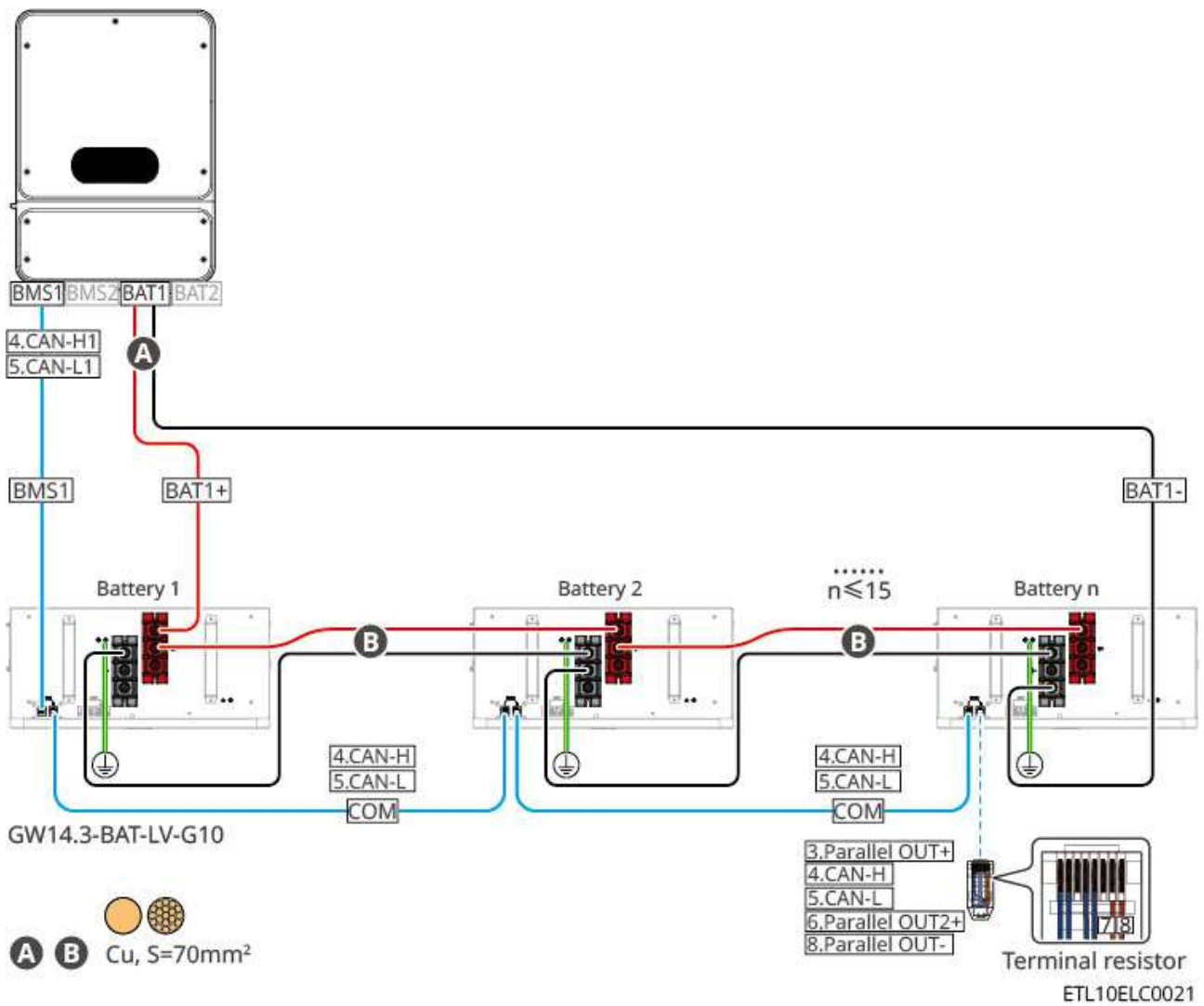

Type 2:

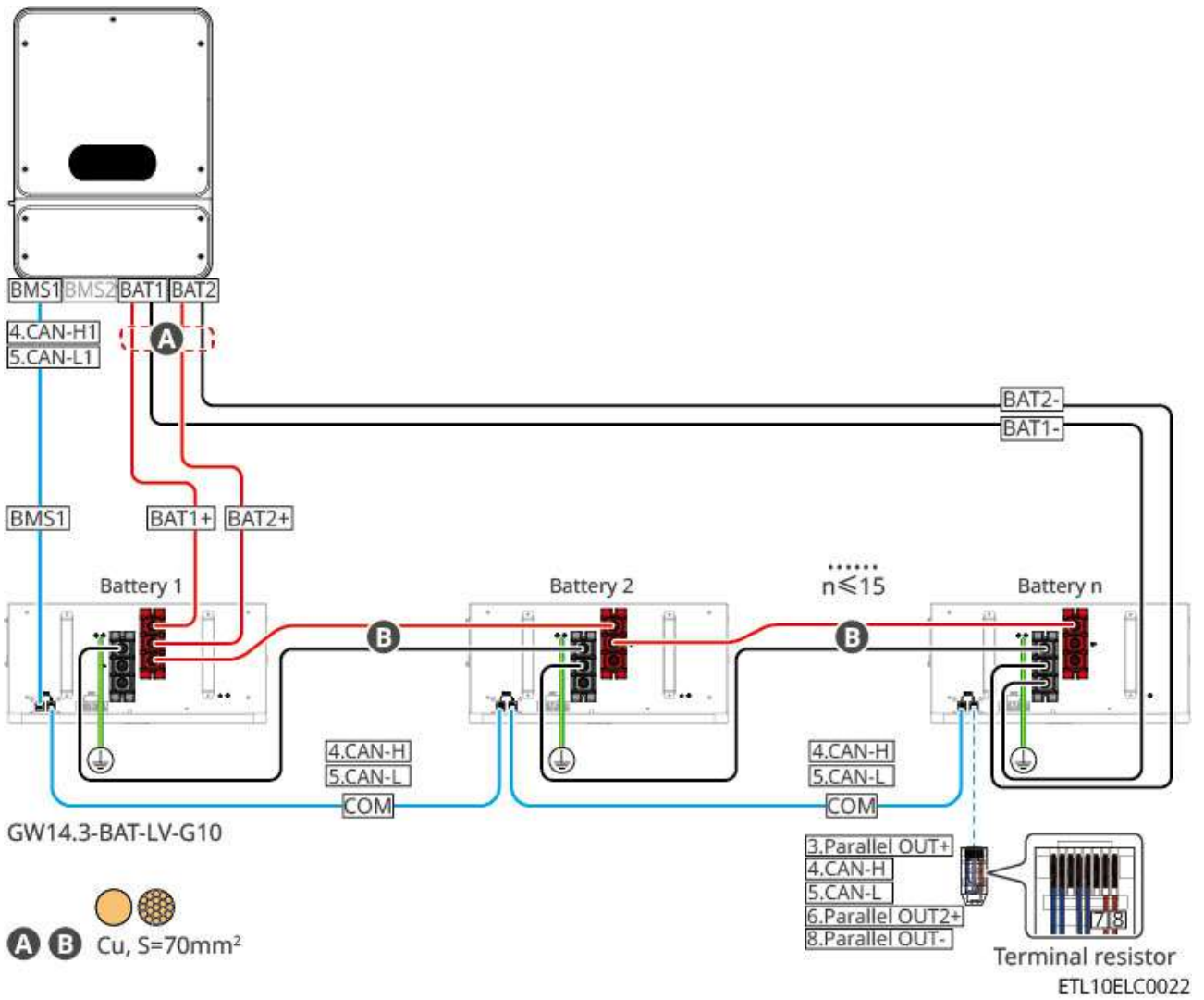

GW14.3-BAT-LV-G10: When dual battery paths are connected to a single inverter with 2 output paths

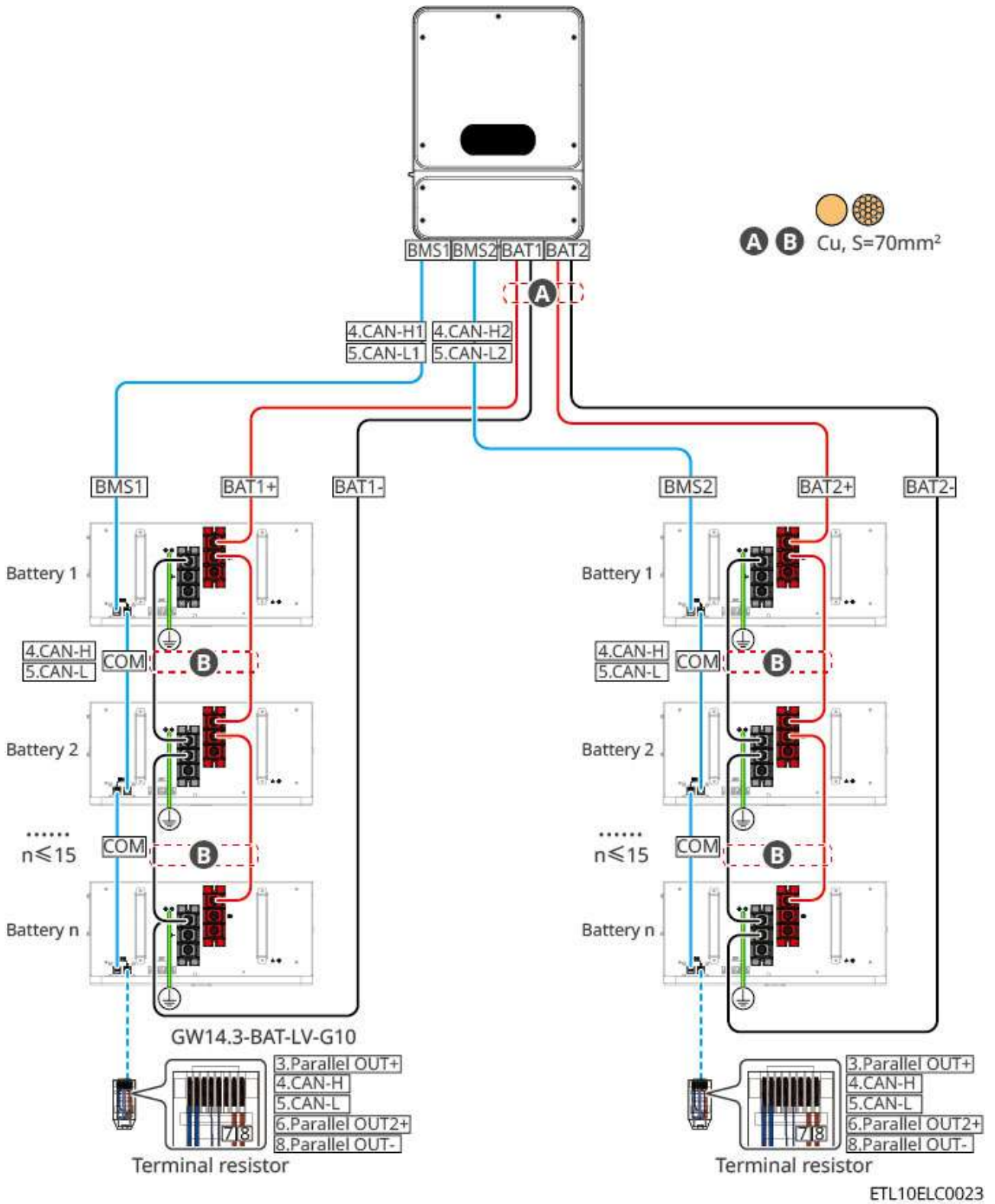

GW14.3-BAT-LV-G10: When batteries are directly connected to 2 inverters with 1 output path each, please use the App to set the battery connection mode to "Combiner Connection".

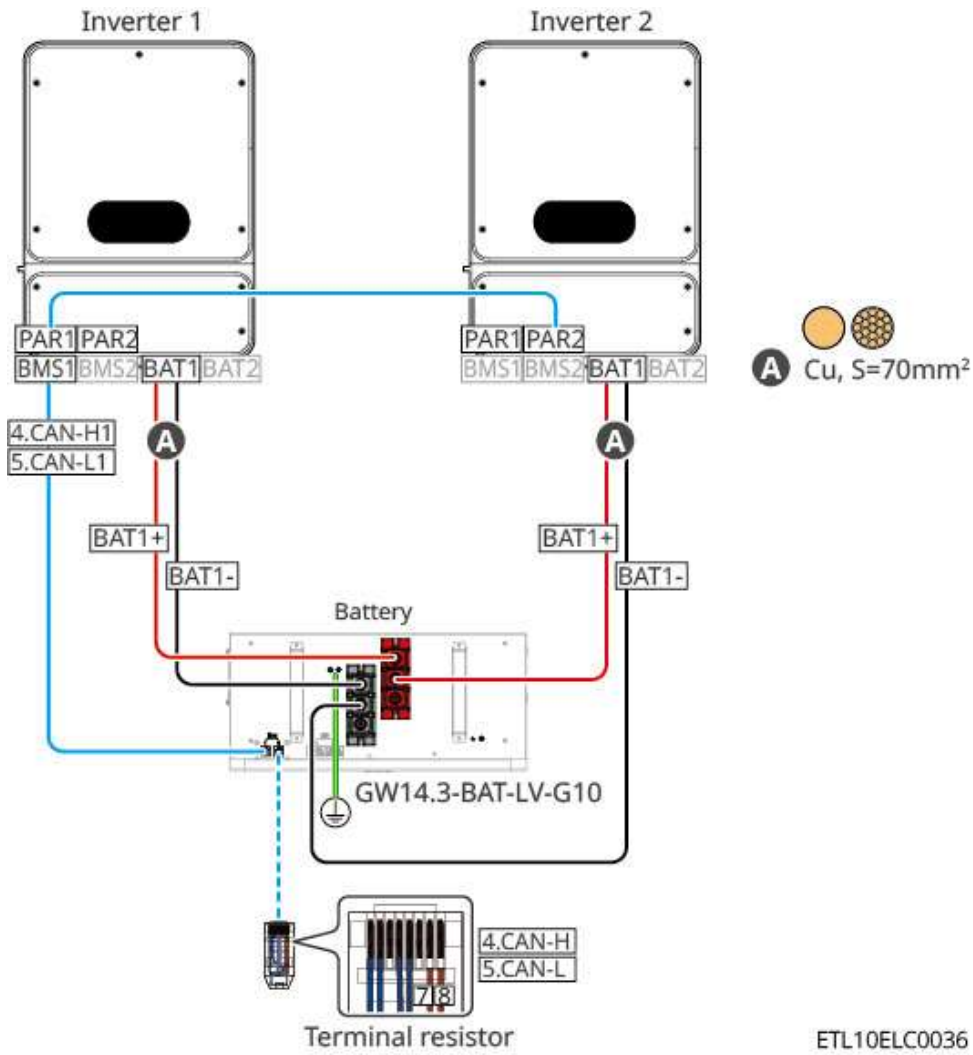

GW14.3-BAT-LV-G10: When the number of batteries is ≤ 15 , using a combiner box (BCB-32-WW-0, current $\leq 720A$) to connect to the inverter:

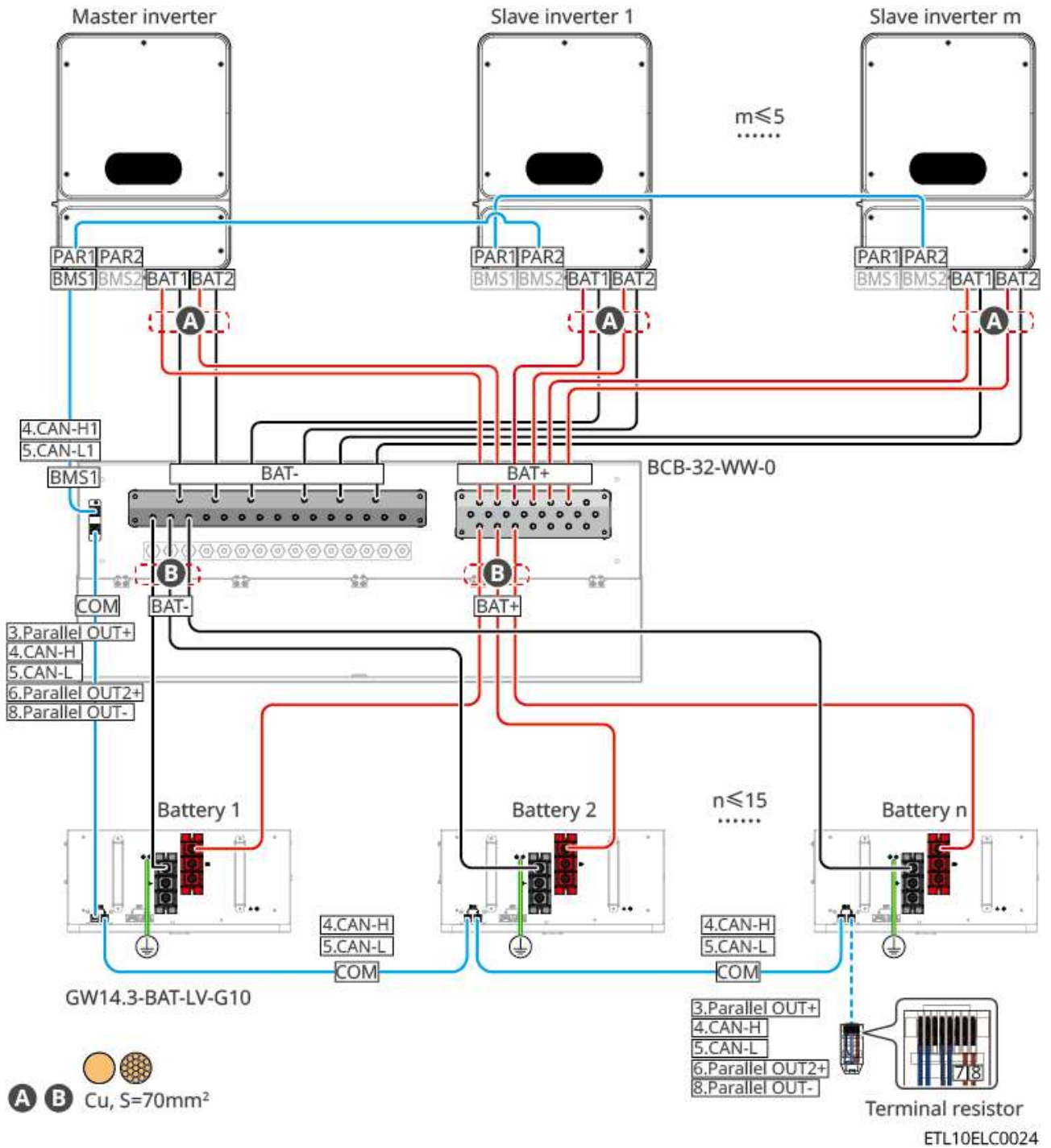

GW14.3-BAT-LV-G10: Connection method with a third-party busbar

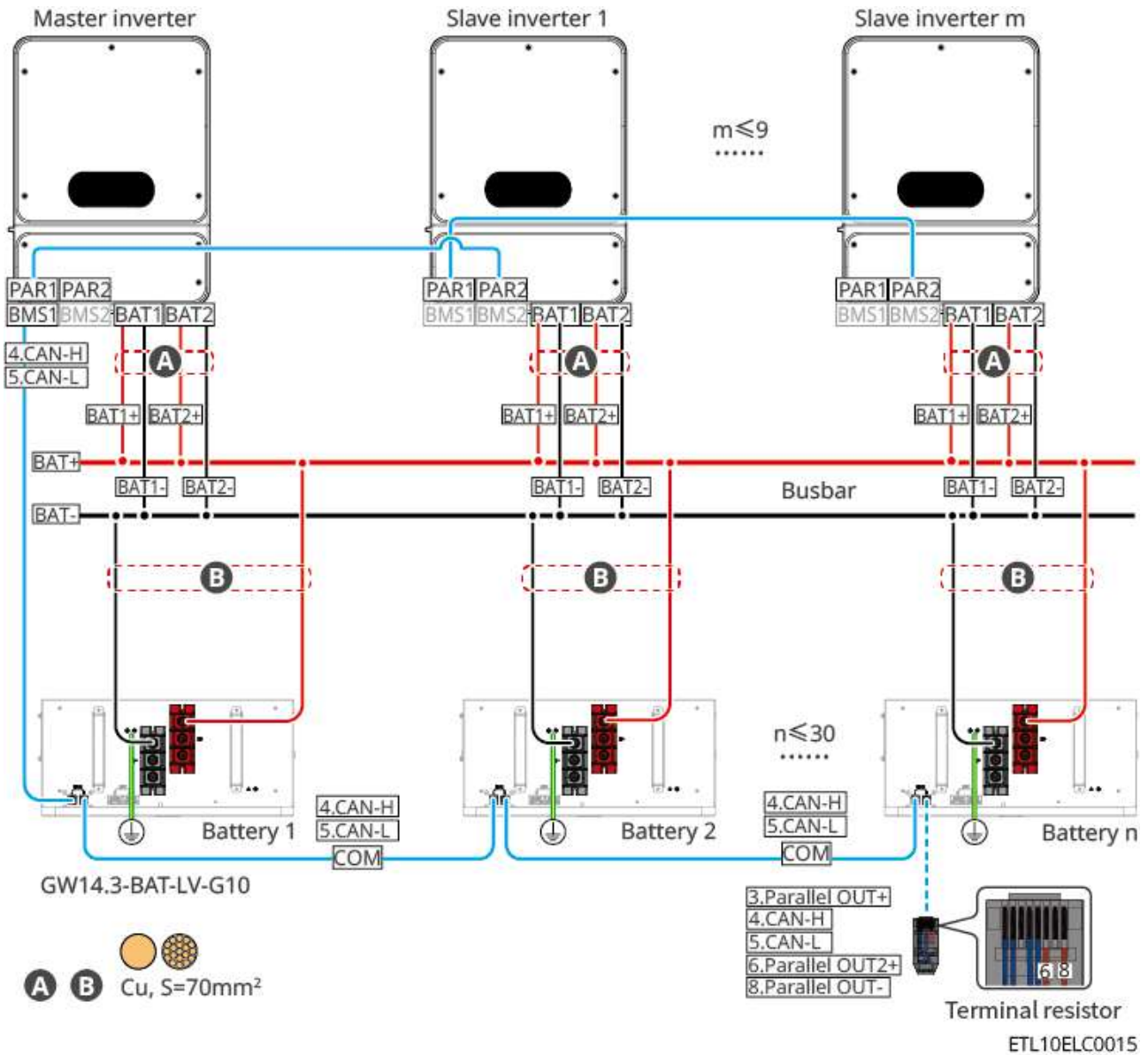

LX U5.0-30: Daisy-chain connection method, when a battery is connected to a single inverter with 2 output paths:

When the number of batteries $n > 8$, a fuse needs to be added. Recommended specifications: Nominal Voltage $\geq 60V$, Rated Current $\geq 300A$, ultimate/operational breaking capacity $\geq 50kA$.

Type 1:

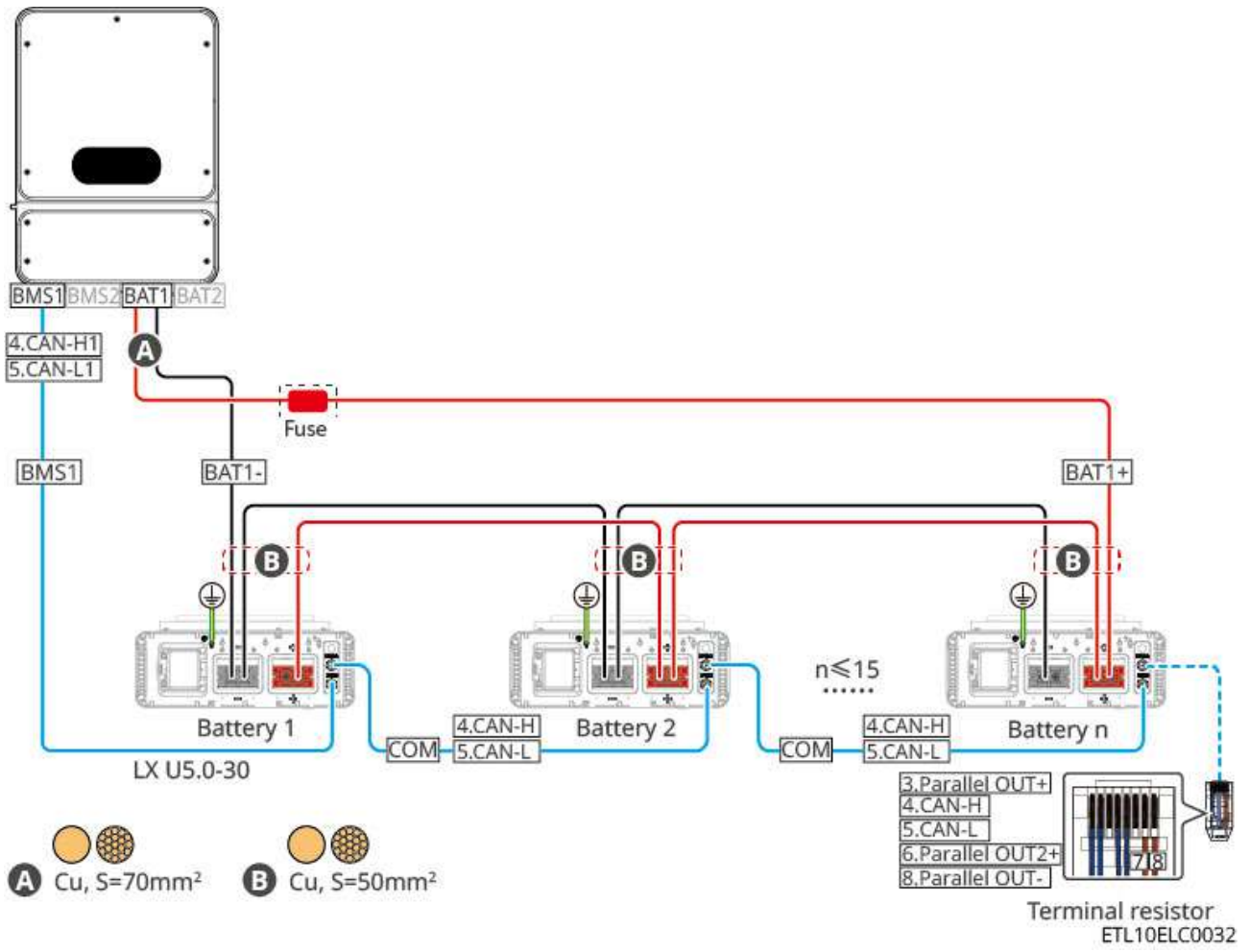

Type 2:

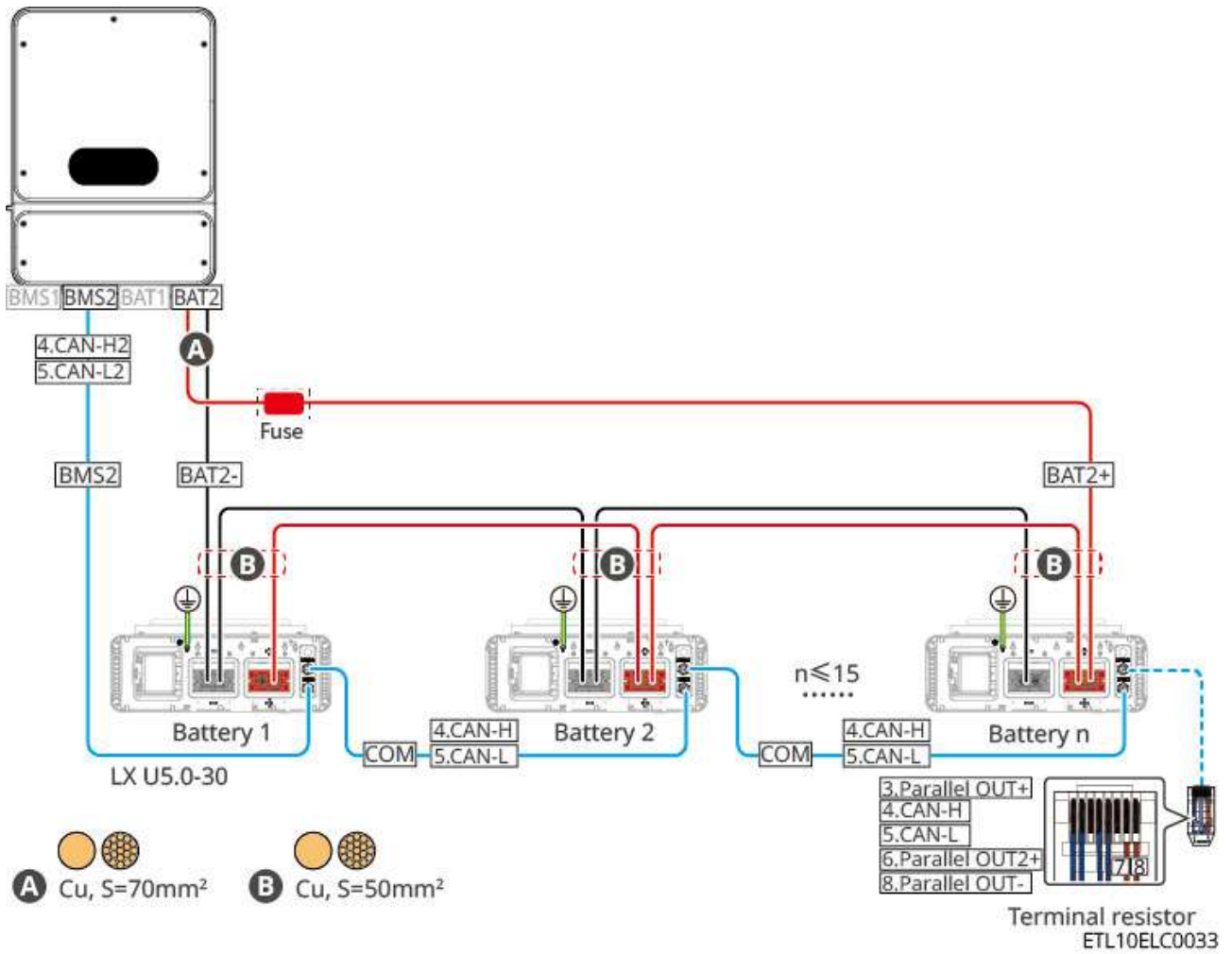

LX U5.0-30: When dual battery paths are connected to a single inverter with 2 output paths

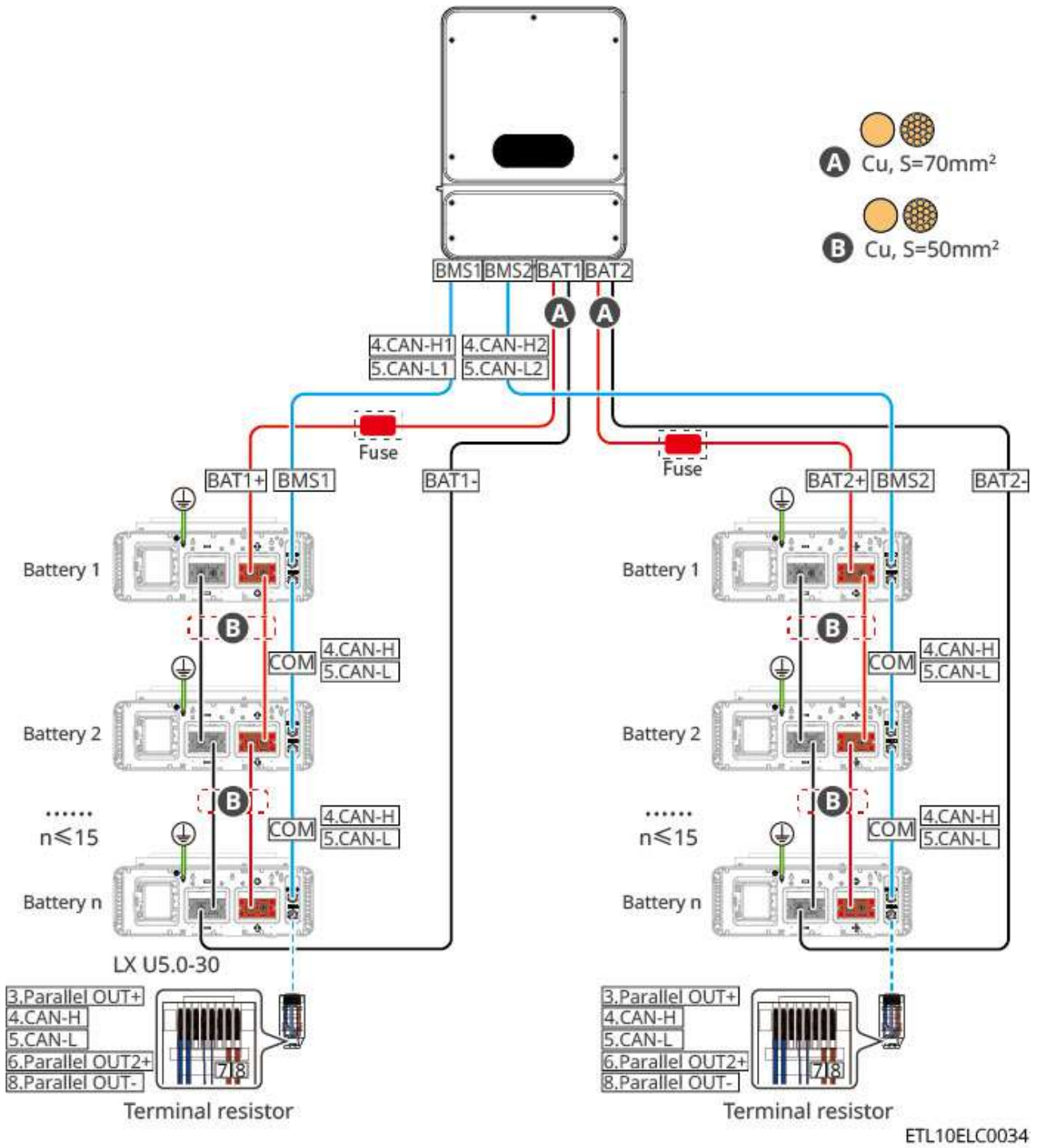

LX U5.0-30: When the number of batteries ≤6, battery connection method with BCB-22-WW-0

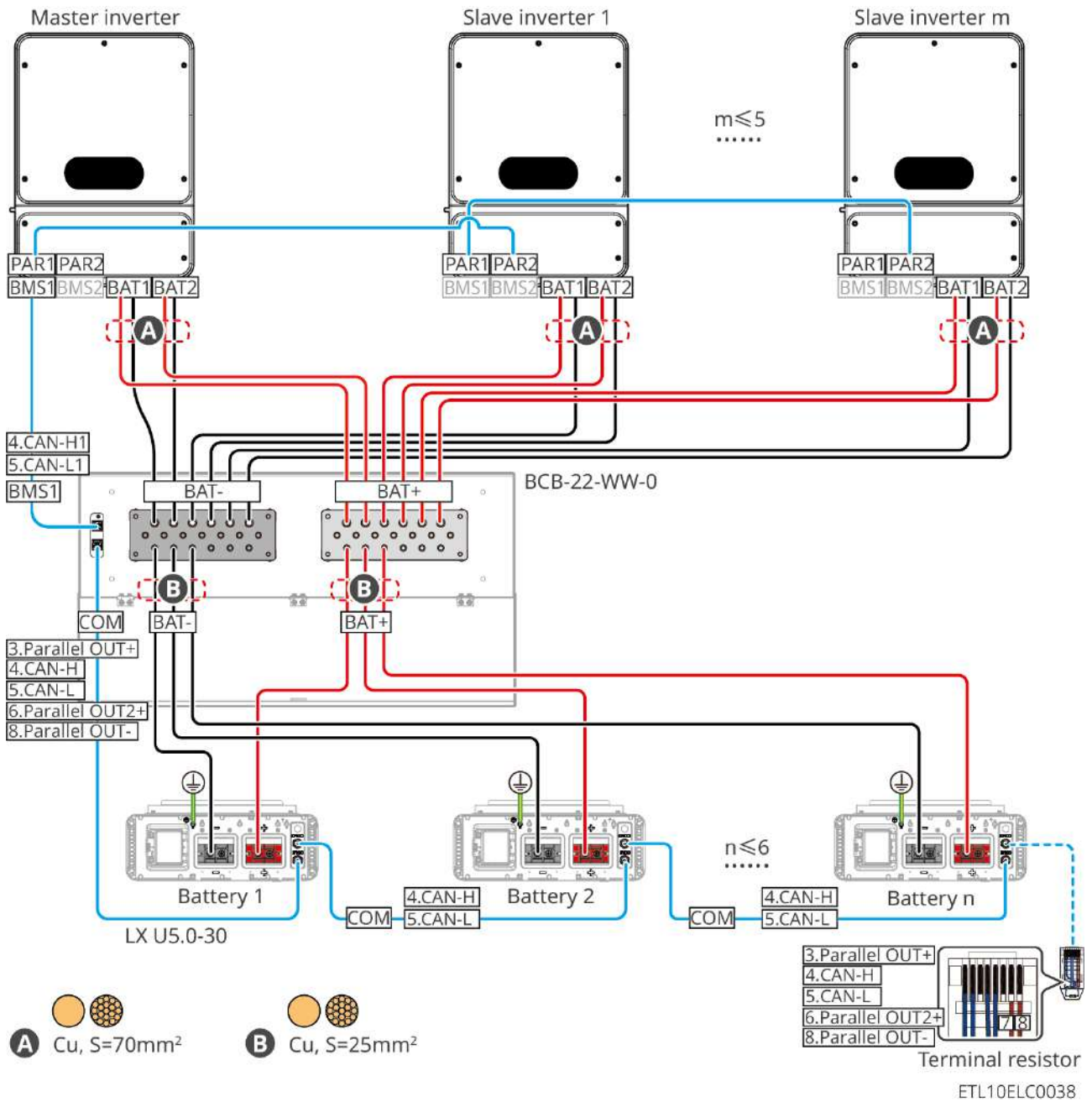

LX U5.0-30: When the number of batteries ≤ 8 , battery connection method with BCB-32-WW-0

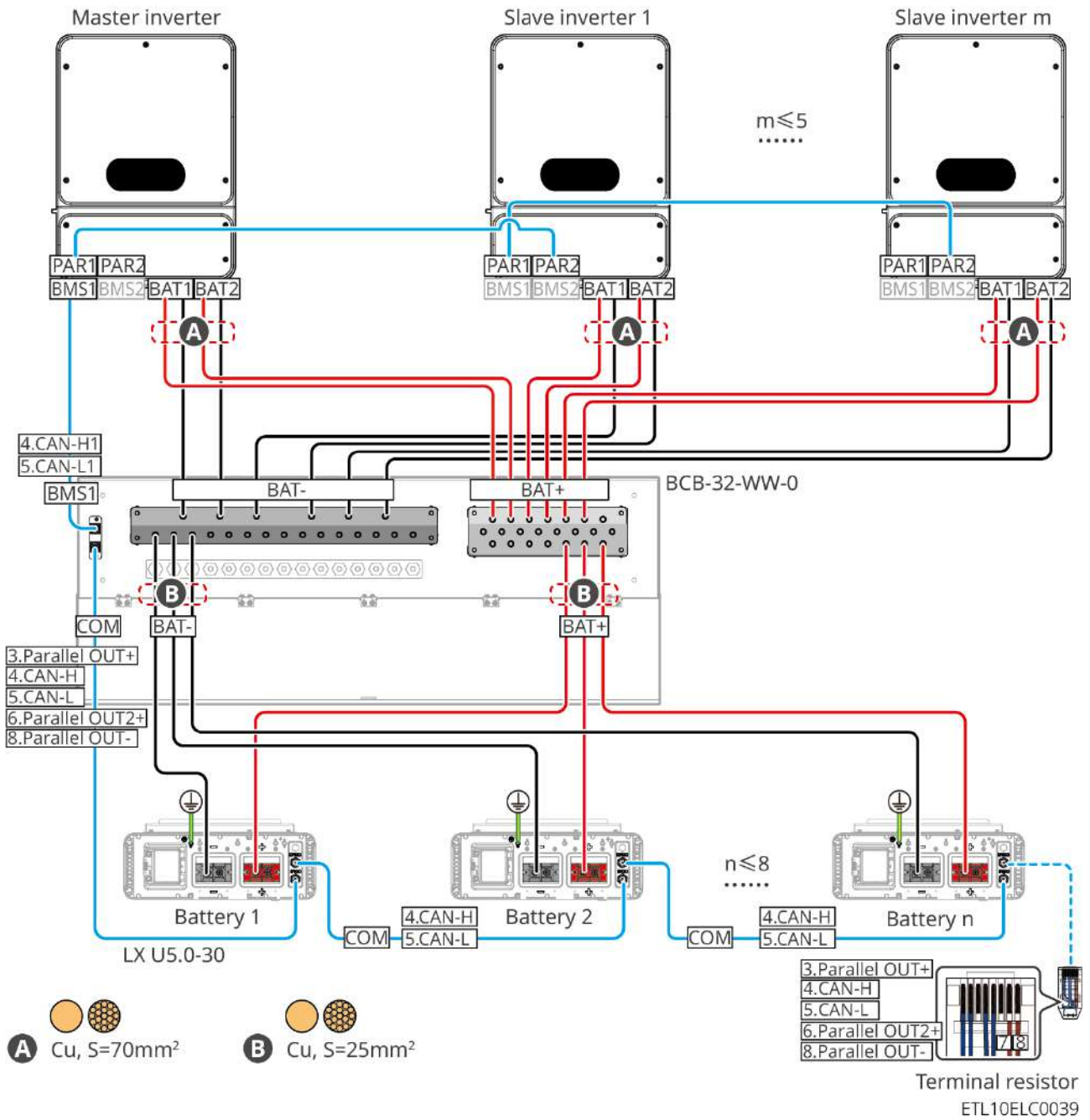

LX U5.0-30: When the number of batteries ≤ 15 , battery connection method with combiner box BCB-33-WW-0

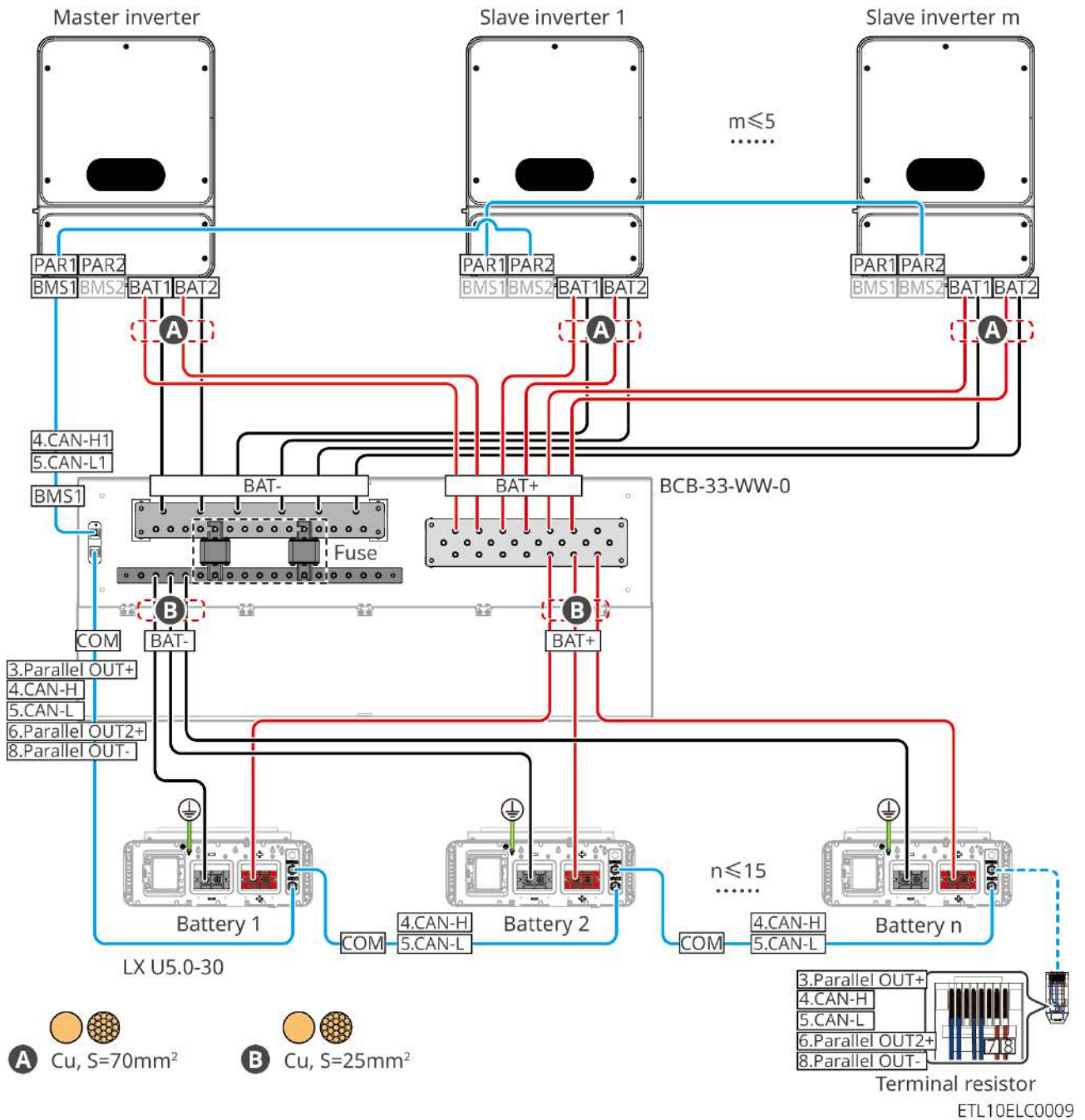

LX U5.0-30: When the number of batteries ≤ 8 , battery connection method with a third-party busbar

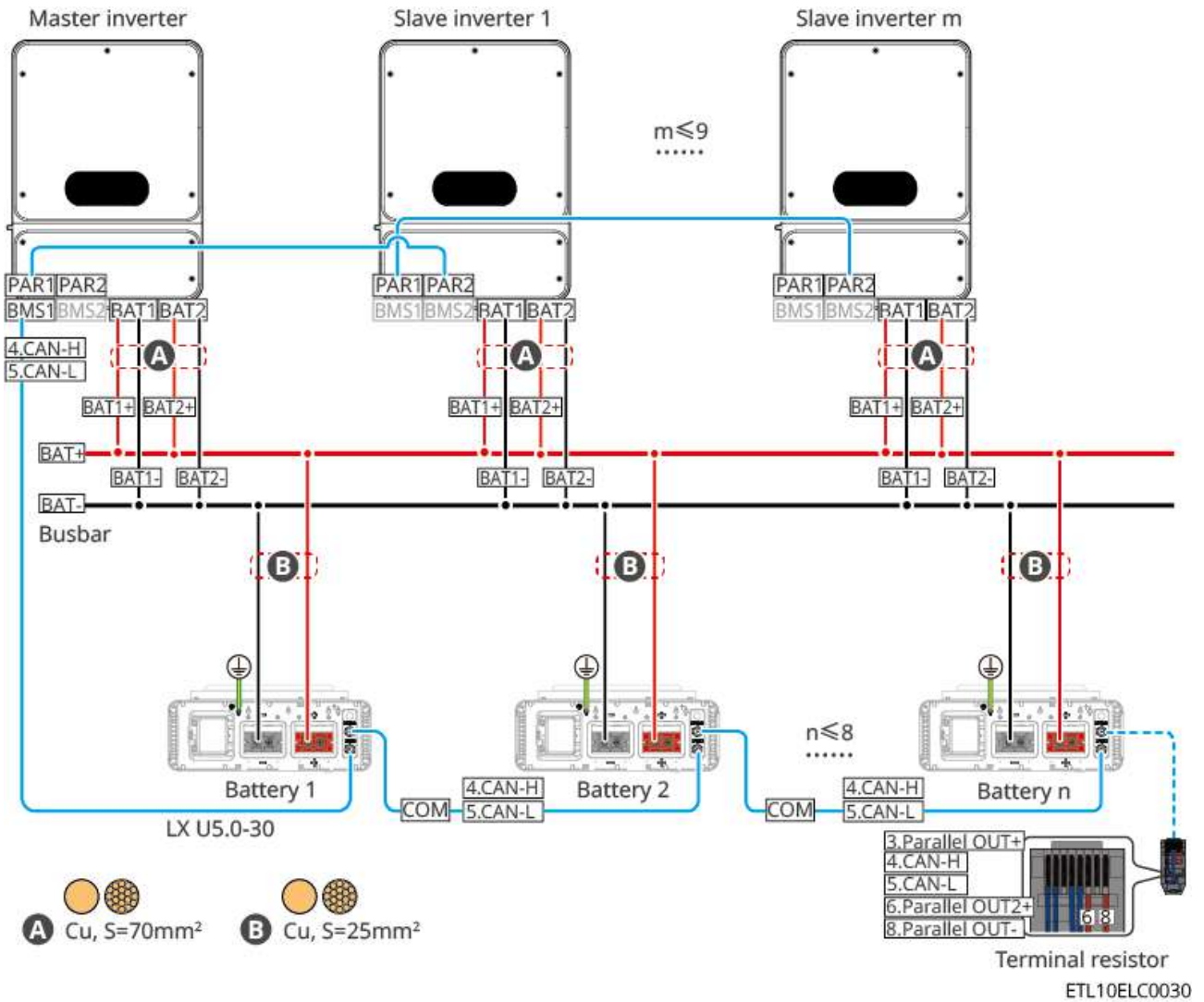

LX U5.0-30: When the number of batteries > 8, battery connection method with a third-party busbar

When the number of batteries $n > 8$, a fuse must be used. Recommended specifications: Nominal Voltage $\geq 80V$, Rated Current ≥ 1.6 times the system rated current, ultimate/operational breaking capacity $\geq 50kA$.

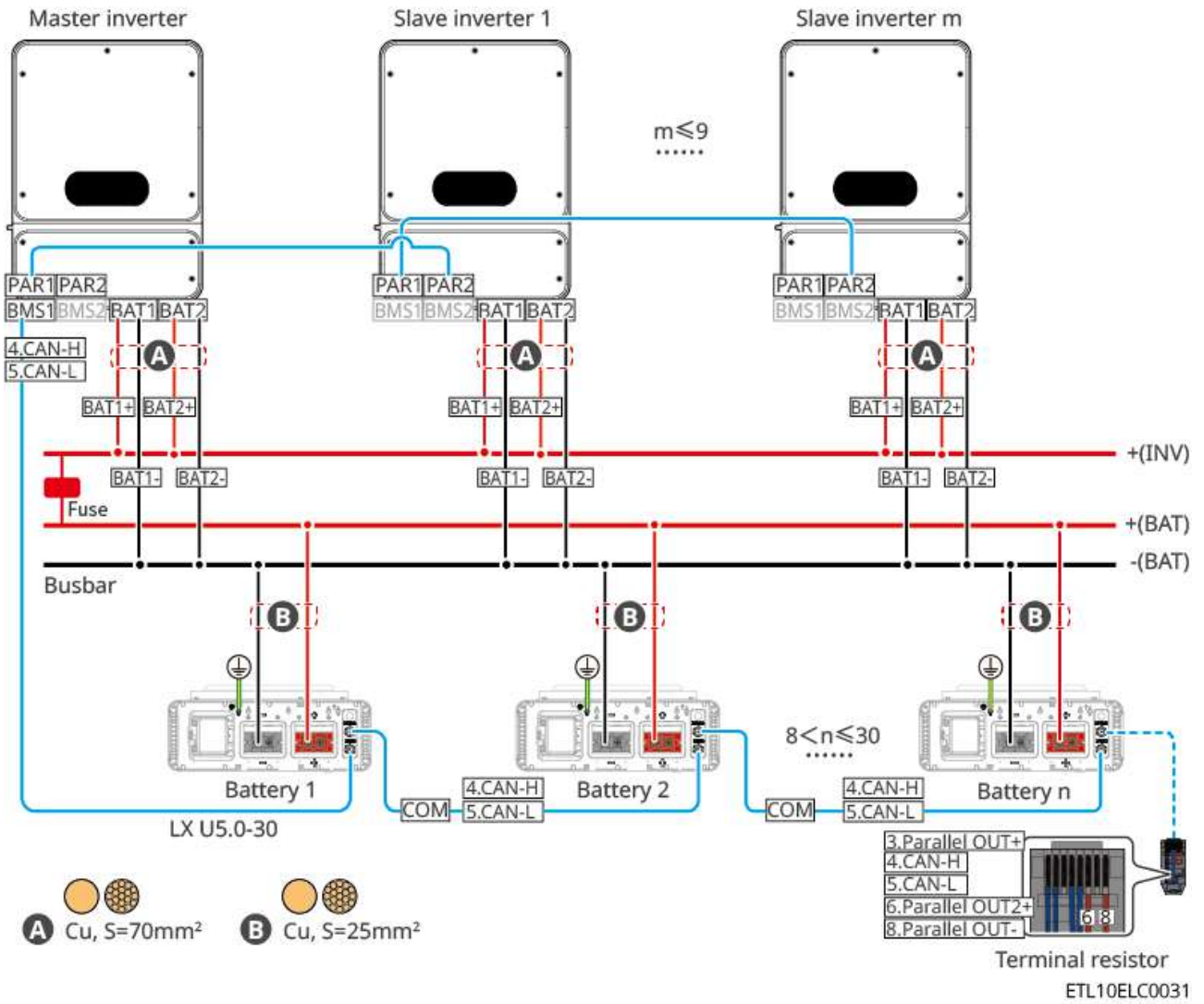

Battery connected to a single inverter with 2 output paths:

Type 1:

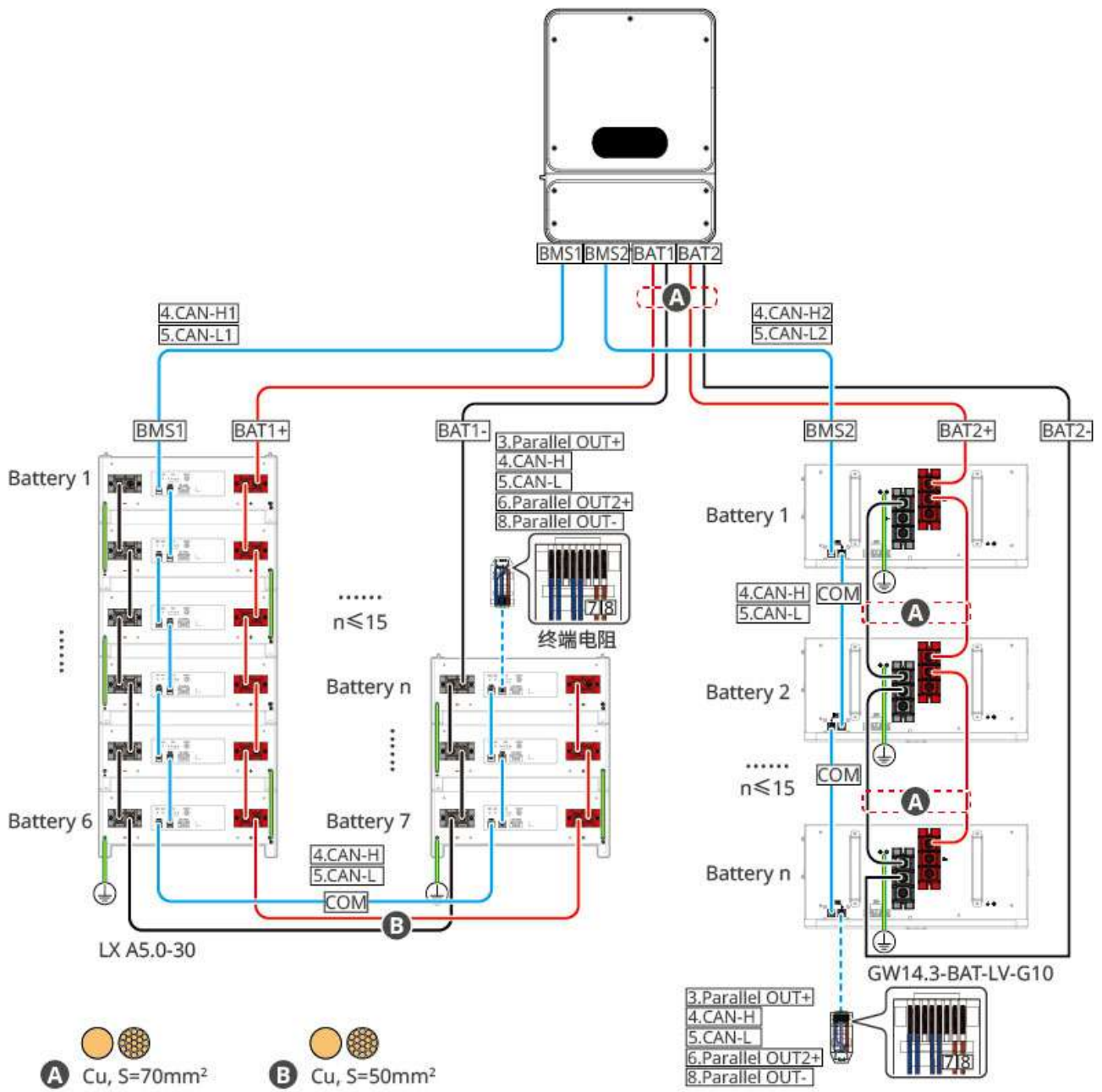

ETL10ELC0025

Type 2:

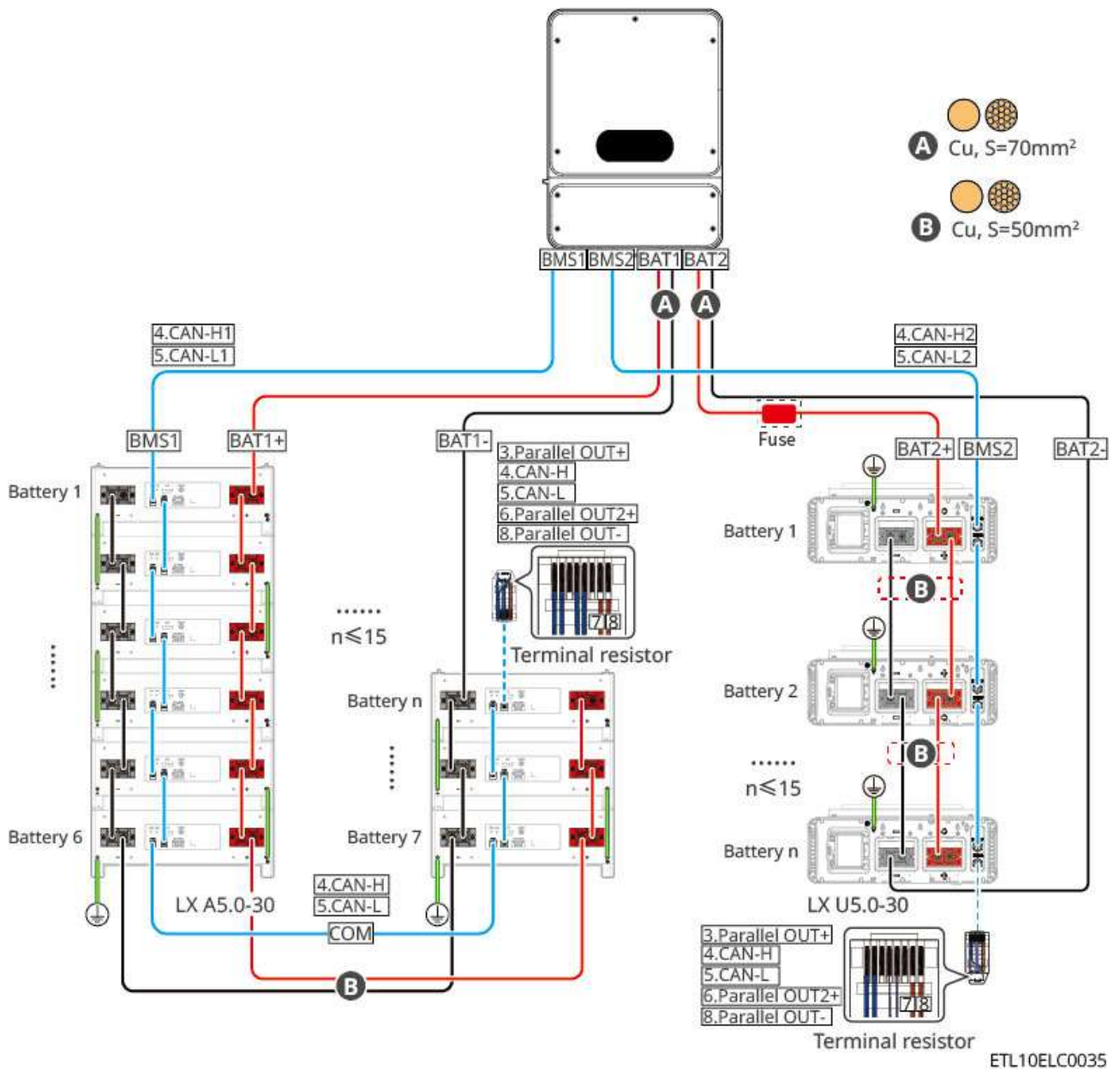

GW16.1-BAT-LV-G10: Single battery path connected to a single inverter with 2 output paths
Type 1:

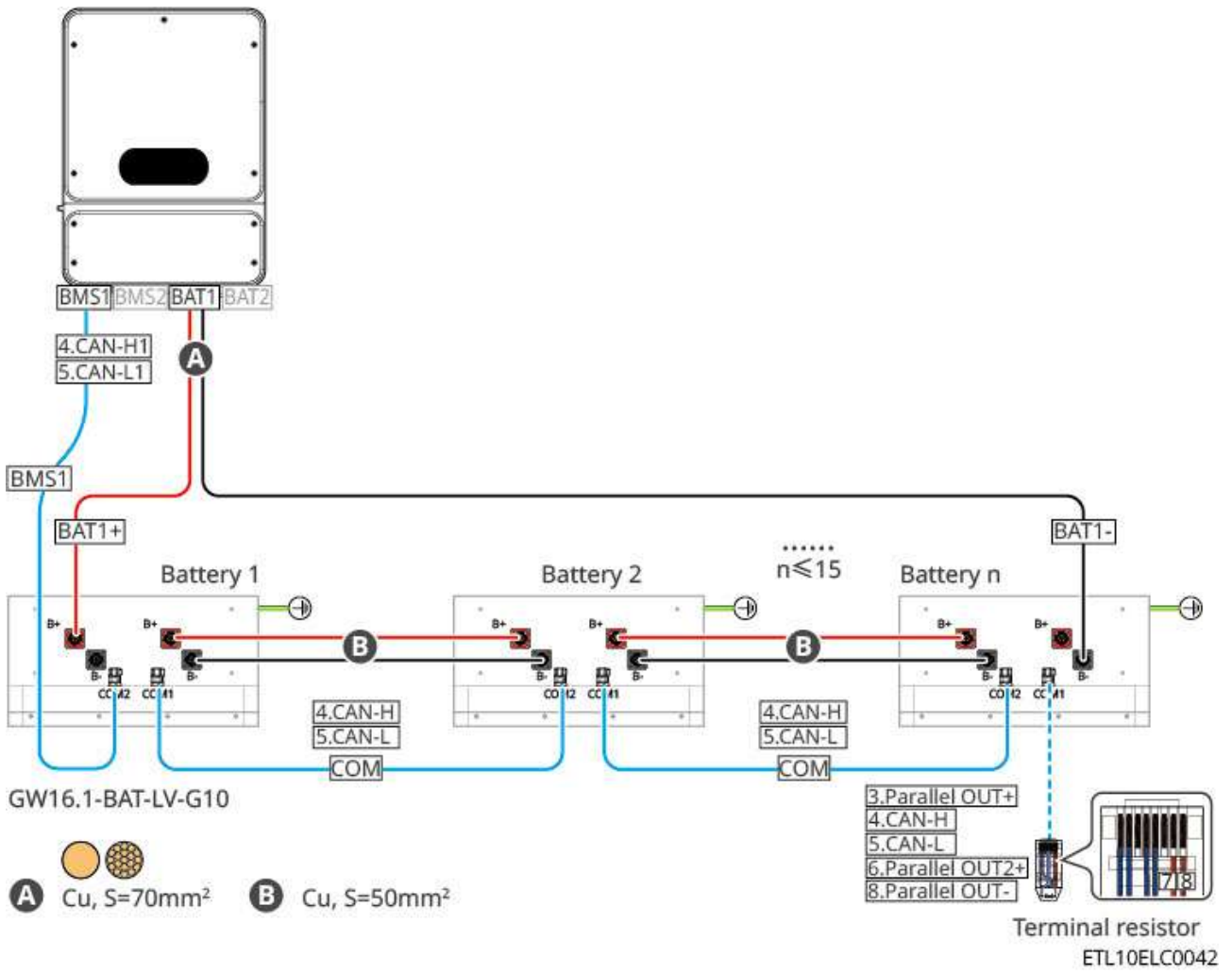

Type 2:

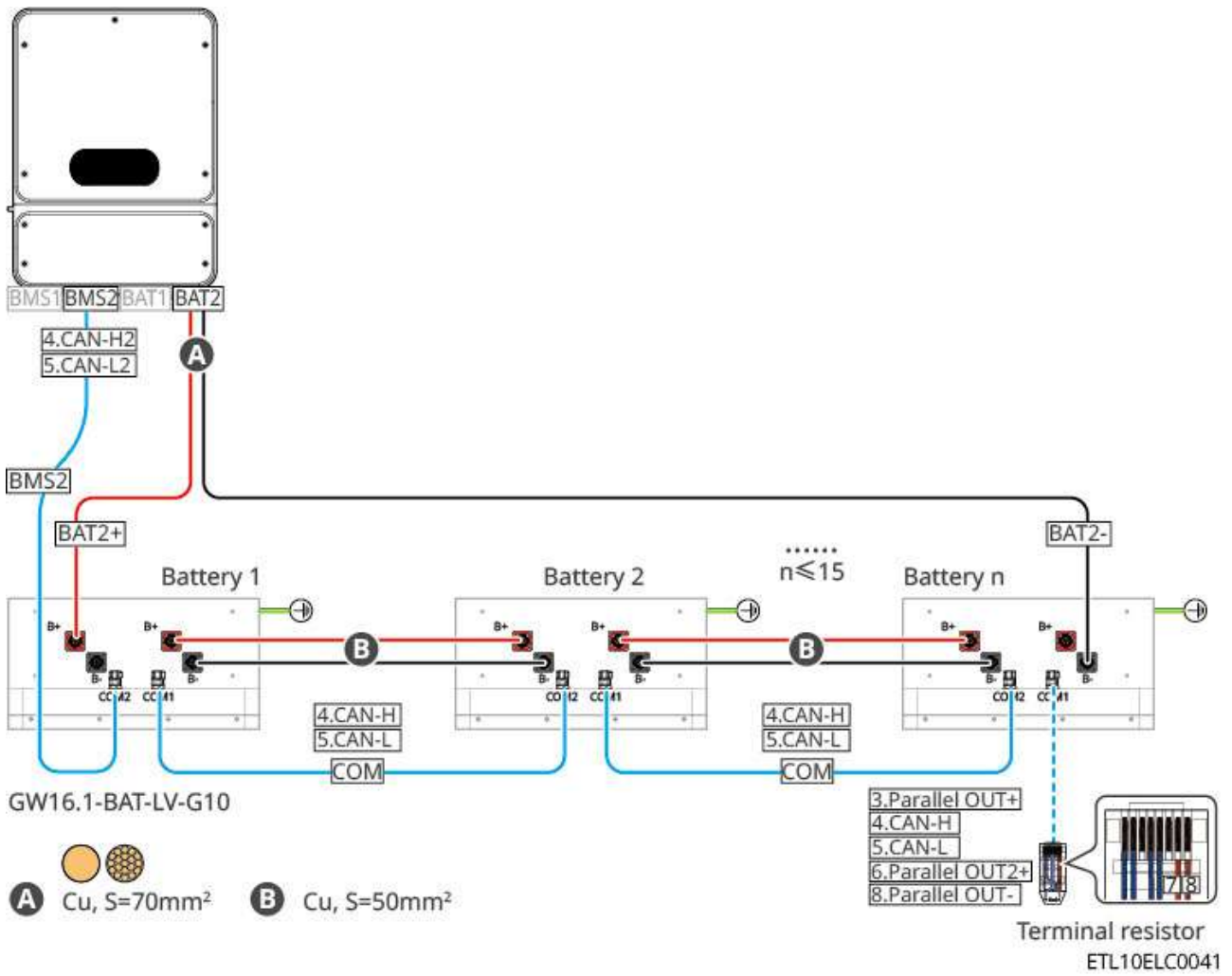

GW16.1-BAT-LV-G10: Dual battery paths connected to a single inverter with 2 output paths

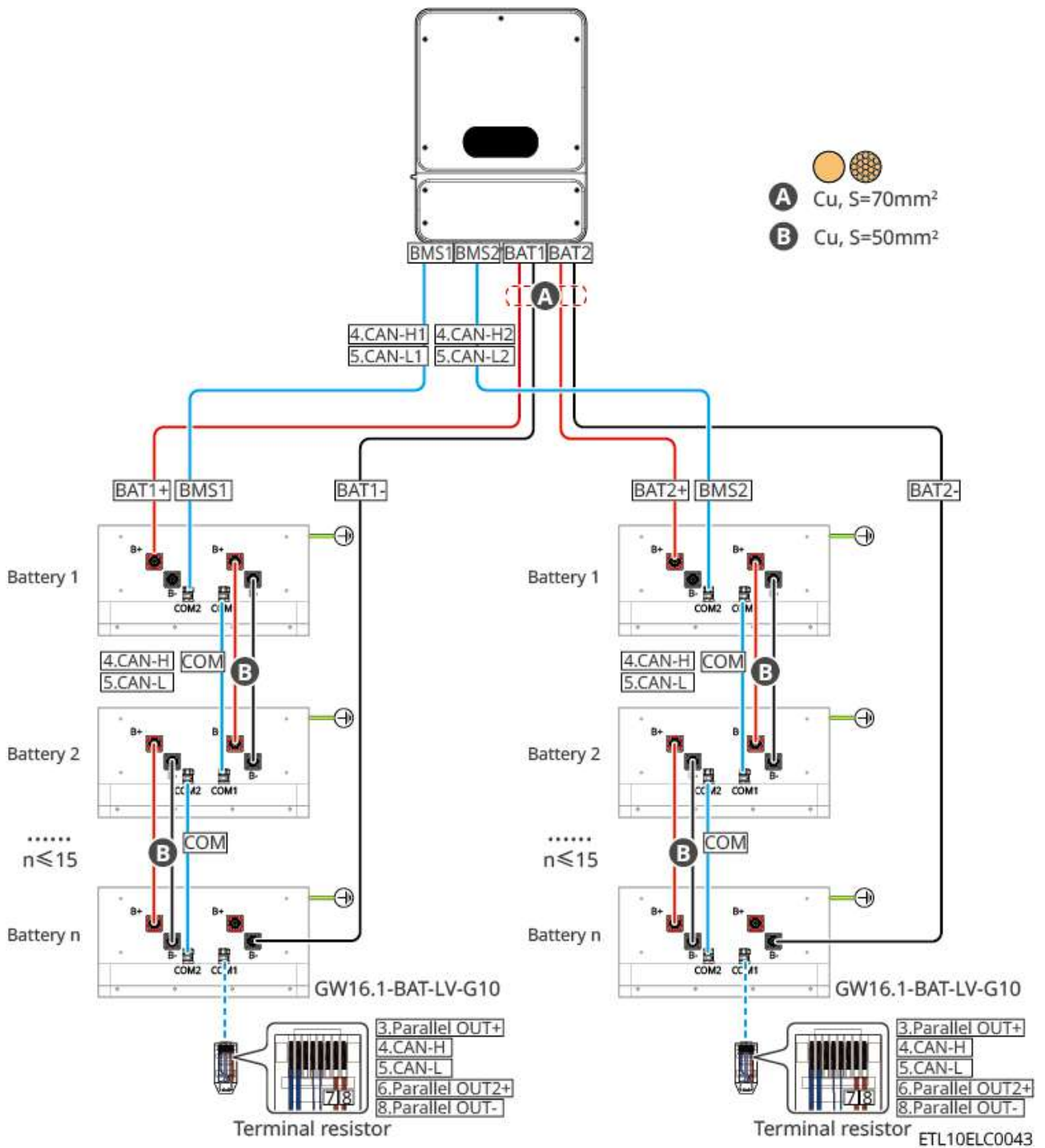

GW16.1-BAT-LV-G10: When the number of batteries is ≤ 15 , using a combiner box (BCB-32-WW-0, current $\leq 720A$) to connect to the inverter:

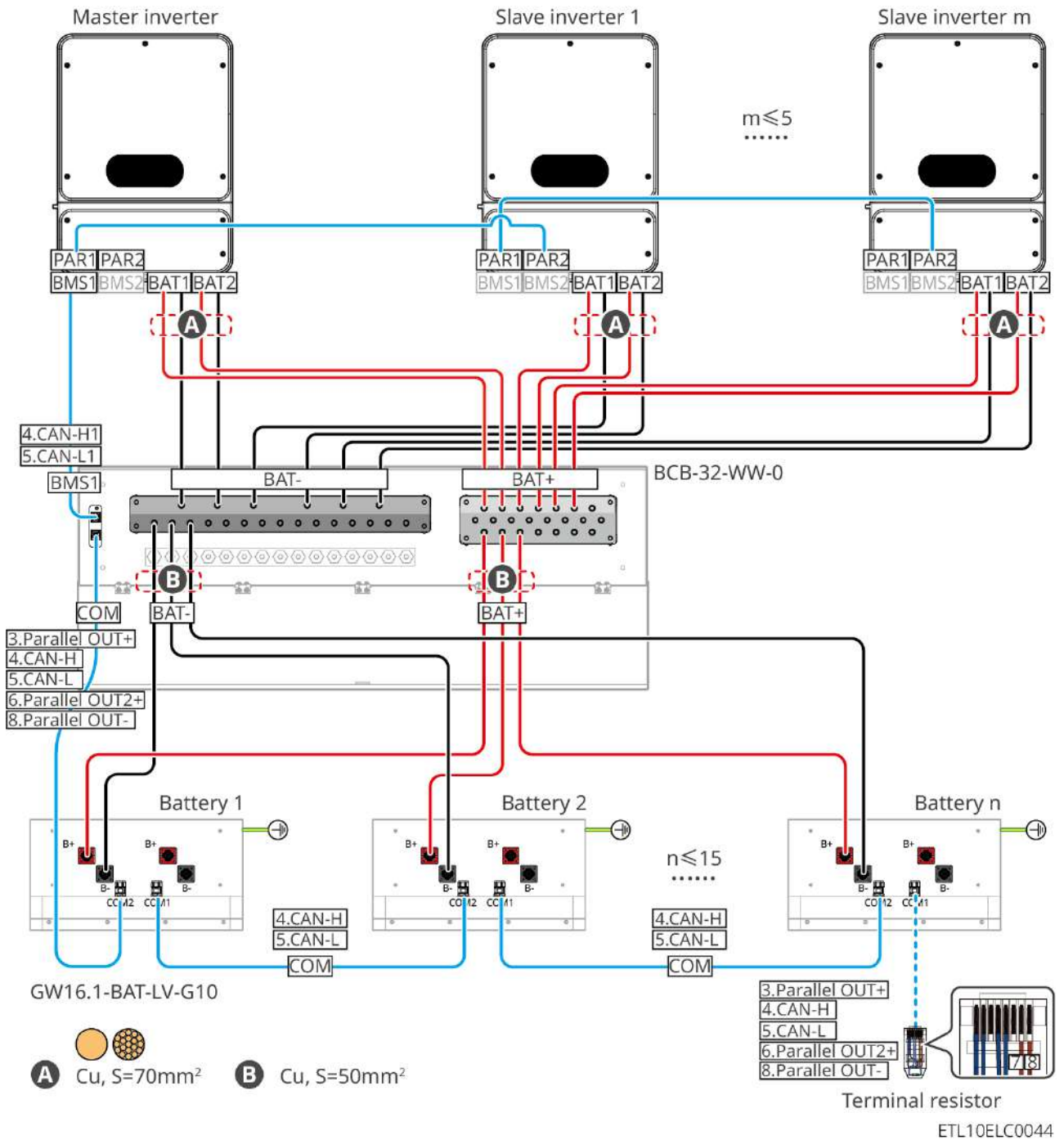

GW16.1-BAT-LV-G10: When the number of batteries is ≤ 30 , using a third-party busbar to connect to the inverter:

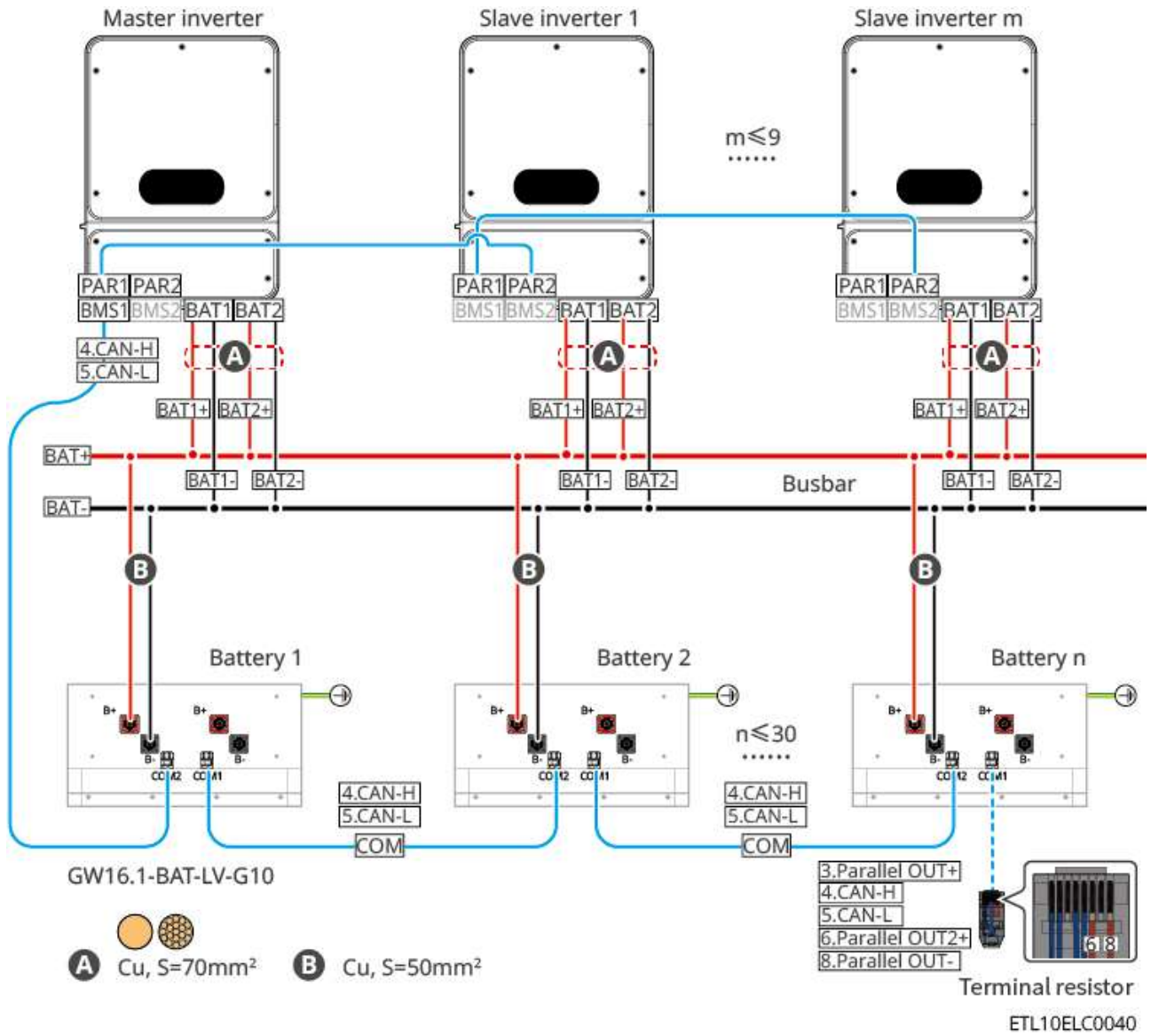

Lead-acid battery connection method with a busbar

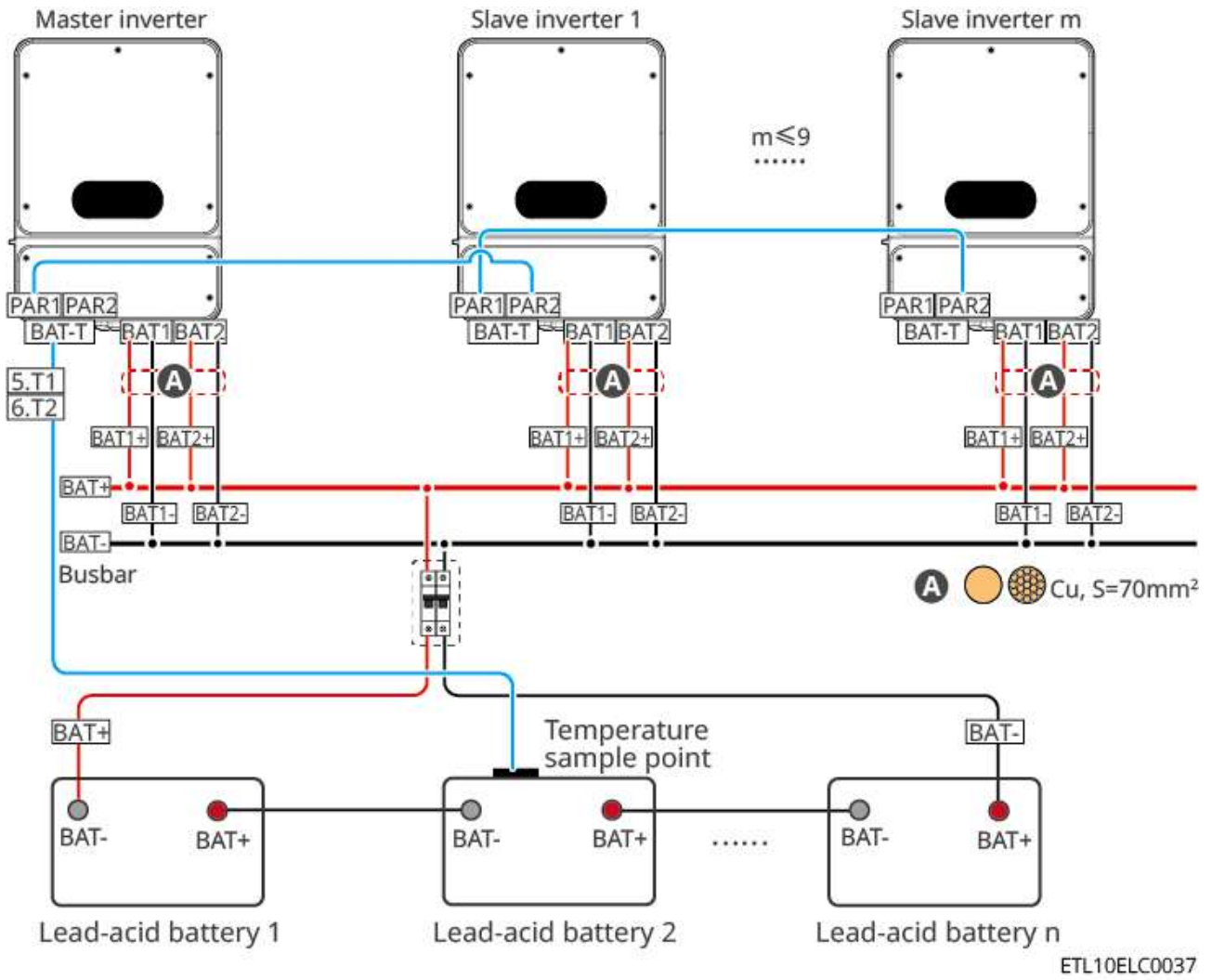

5.8.1 Connecting the Power Cable between the Inverter and Battery

⚠ WARNING

- Use a multimeter to measure the positive and negative terminals of the DC cable to ensure correct polarity (no reverse connection) and that the voltage is within the allowable range.
- During wiring, ensure the battery cables fully match the "BAT+", "BAT-", and ground terminals on the battery end. Incorrect cable connection will cause equipment damage.
- Ensure the wire cores are fully inserted into the terminal connection holes with no exposed parts.
- Ensure the cable connections are tight. Otherwise, loose connections may cause terminal overheating and equipment damage during operation.
- Do not connect the same battery bank to multiple inverters, as this may cause inverter damage.

NOTICE

GW14.3-BAT-LV-G10:

- If a battery power cable is provided inside the packaging box, please use that cable directly; no crimping operation is required.
- If a battery power cable is not provided inside the packaging box, please follow the steps below to make the cable.

Overview of Inverter and Battery Power Cables

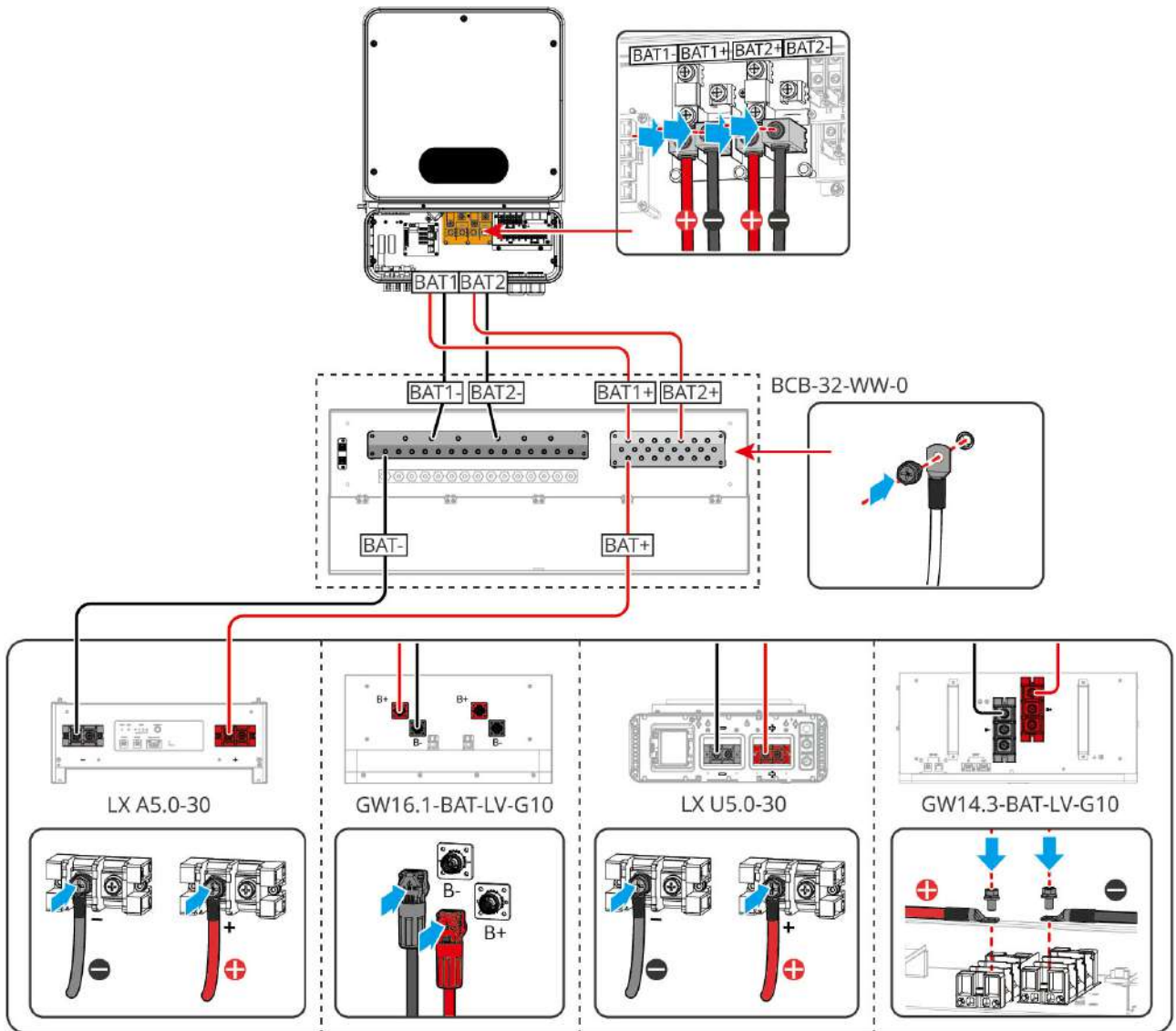

ETL10ELC0010

Inverter-end Cable Assembly

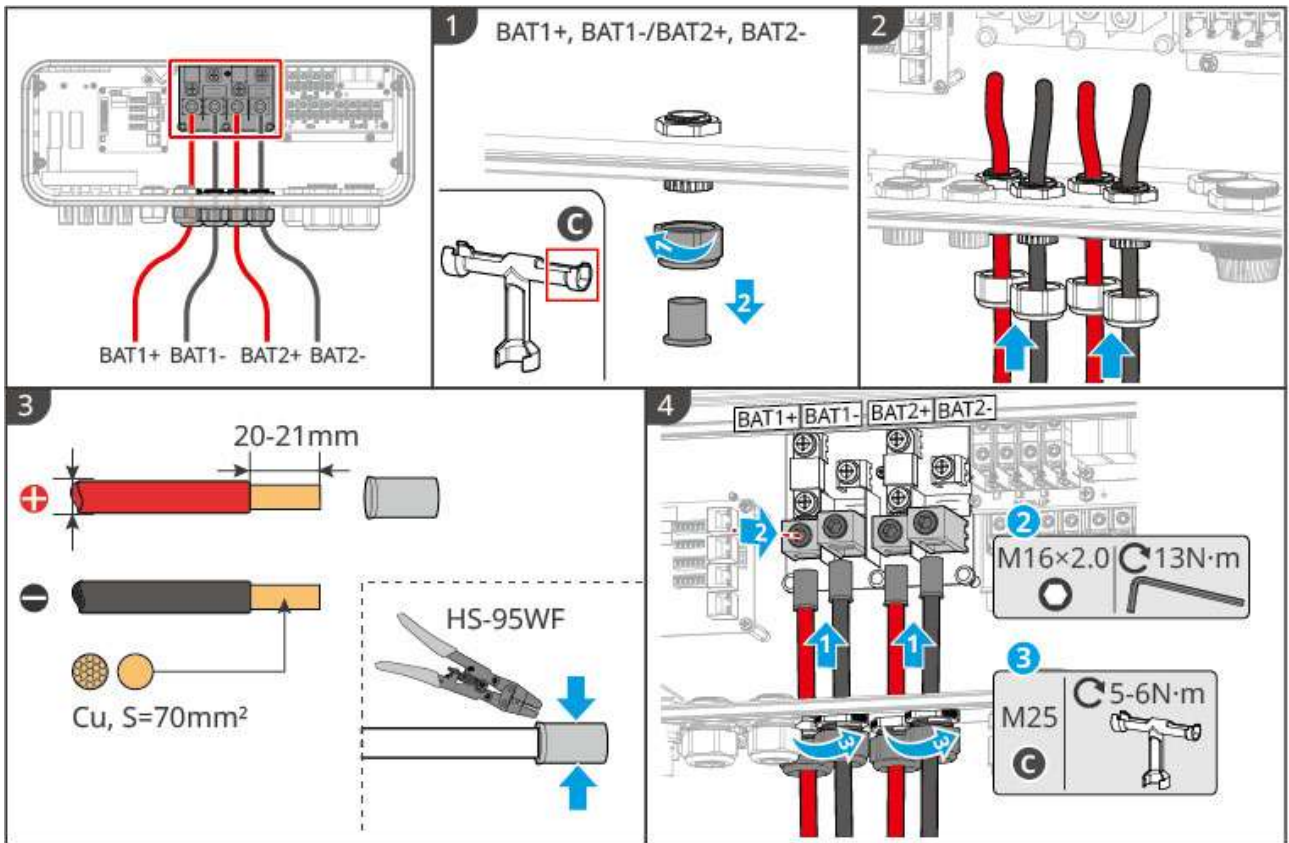

ETL10ELC0004

Cable Assembly Method for the Battery and Combiner Box End (LX A5.0-30)

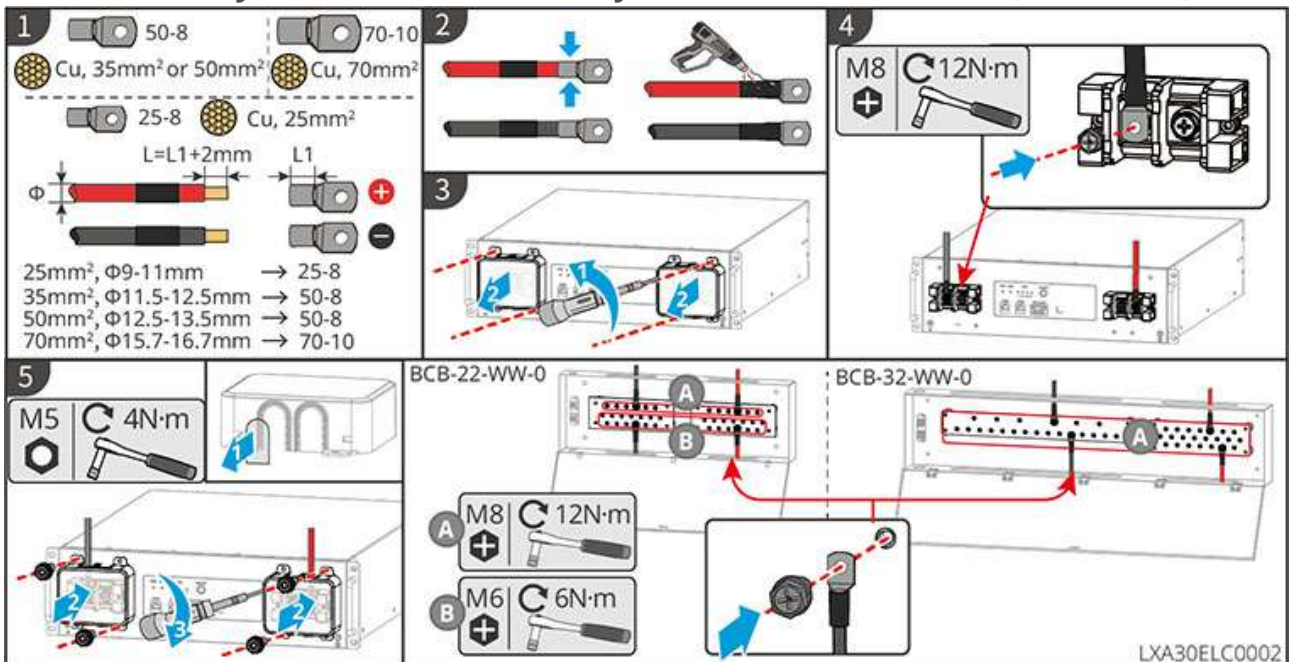

LXA30ELC0002

Cable Assembly Method for the Battery and Combiner Box End (GW14.3-BAT-LV-G10)

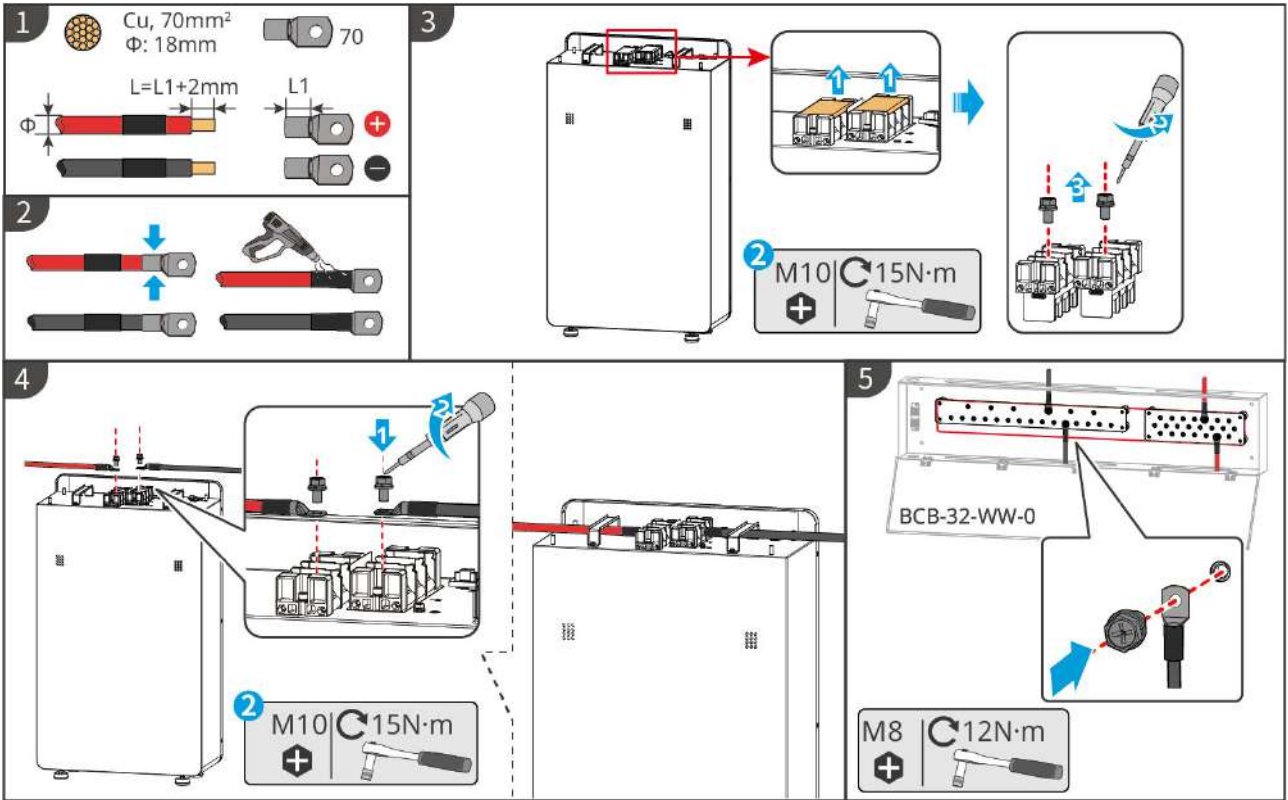

LXA10ELC0015

Cable Assembly Method for the Battery and Combiner Box End (LX U5.0-30)

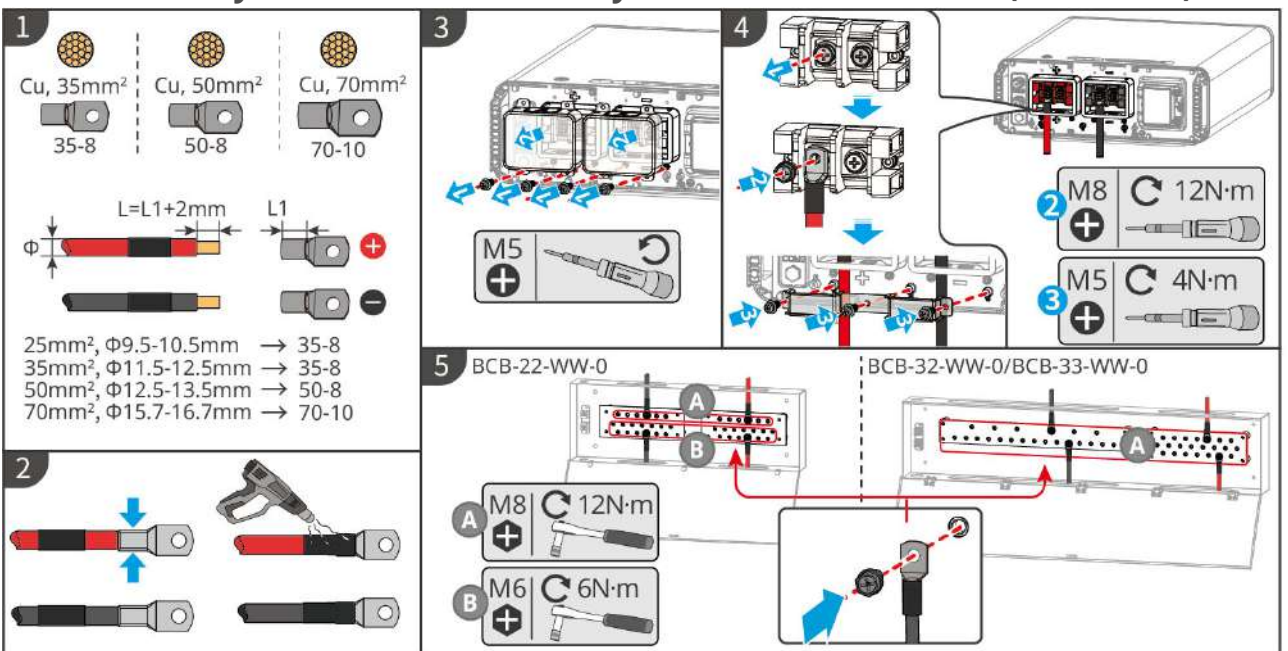

LXU30ELC0004

Cable Assembly Method for the Battery End (GW16.1-BAT-LV-G10)

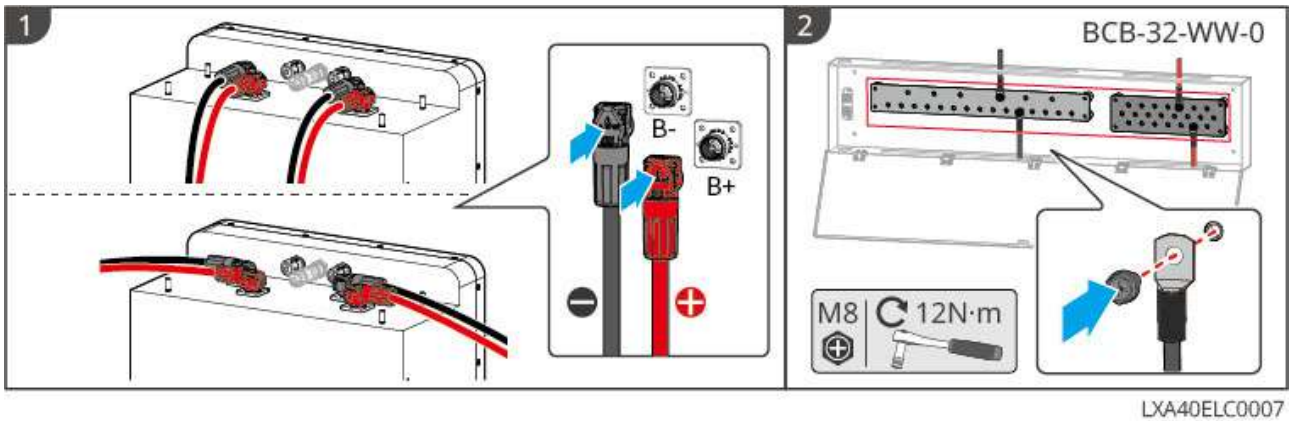

Battery DC Quick-Connect Terminal Unlocking Method (Optional)

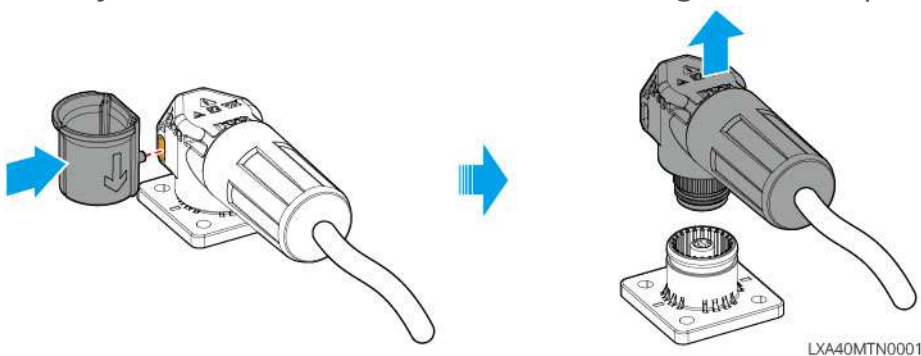

5.8.2 Connecting the Communication Cable between the Inverter and Battery

NOTICE

The inverter is supplied with a BMS battery communication cable in the package. It is recommended to use the supplied BMS battery communication cable. If the supplied communication cable cannot meet the requirements, please prepare your own shielded network cable and a shielded RJ45 connector. When crimping the cable, only crimp PIN4 and PIN5 of the connector; otherwise, communication failure may occur.

Connecting inverter BMS1 communication schematic:

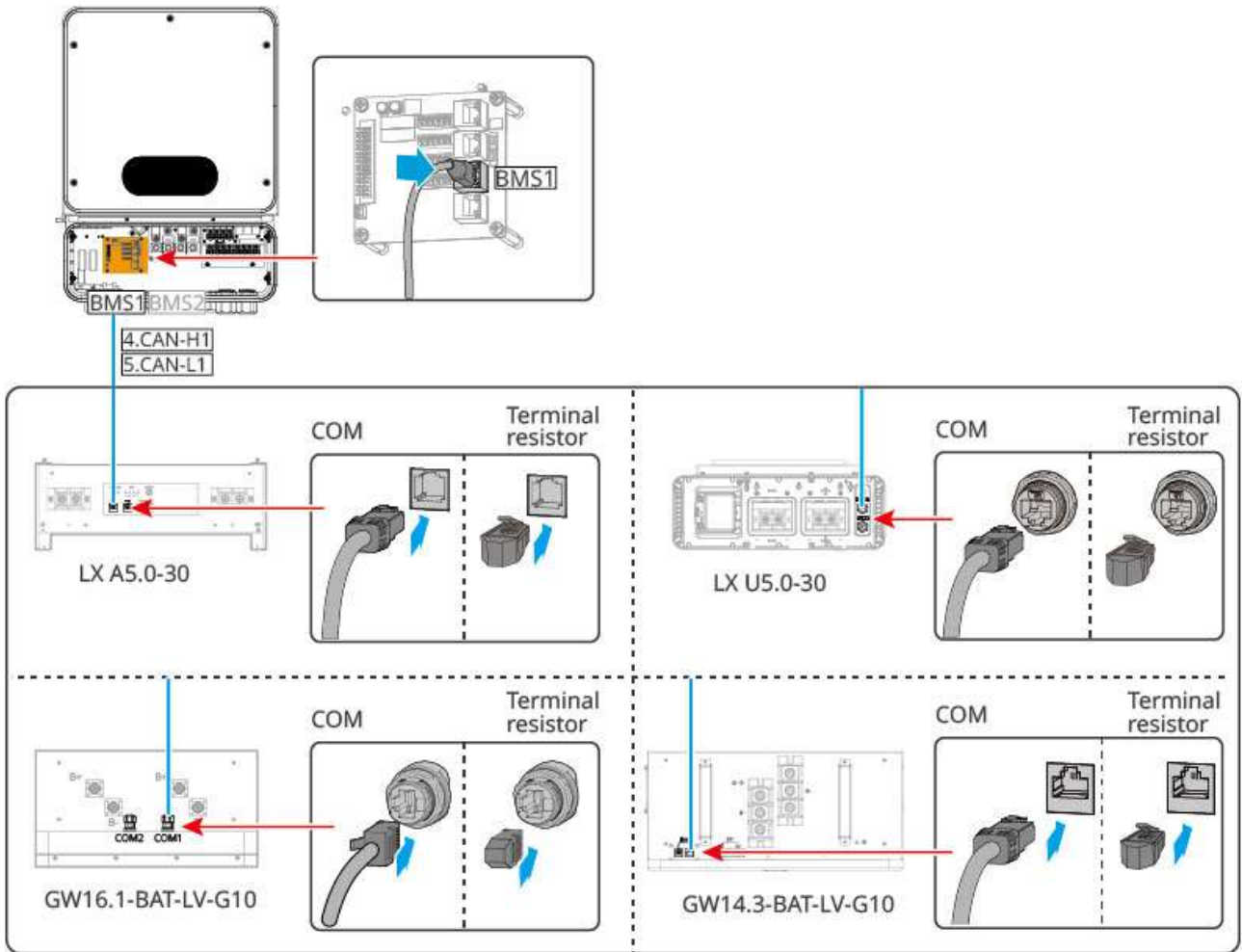

ETL10ELC0008

Inverter BMS1 and BMS2 both connected communication schematic:

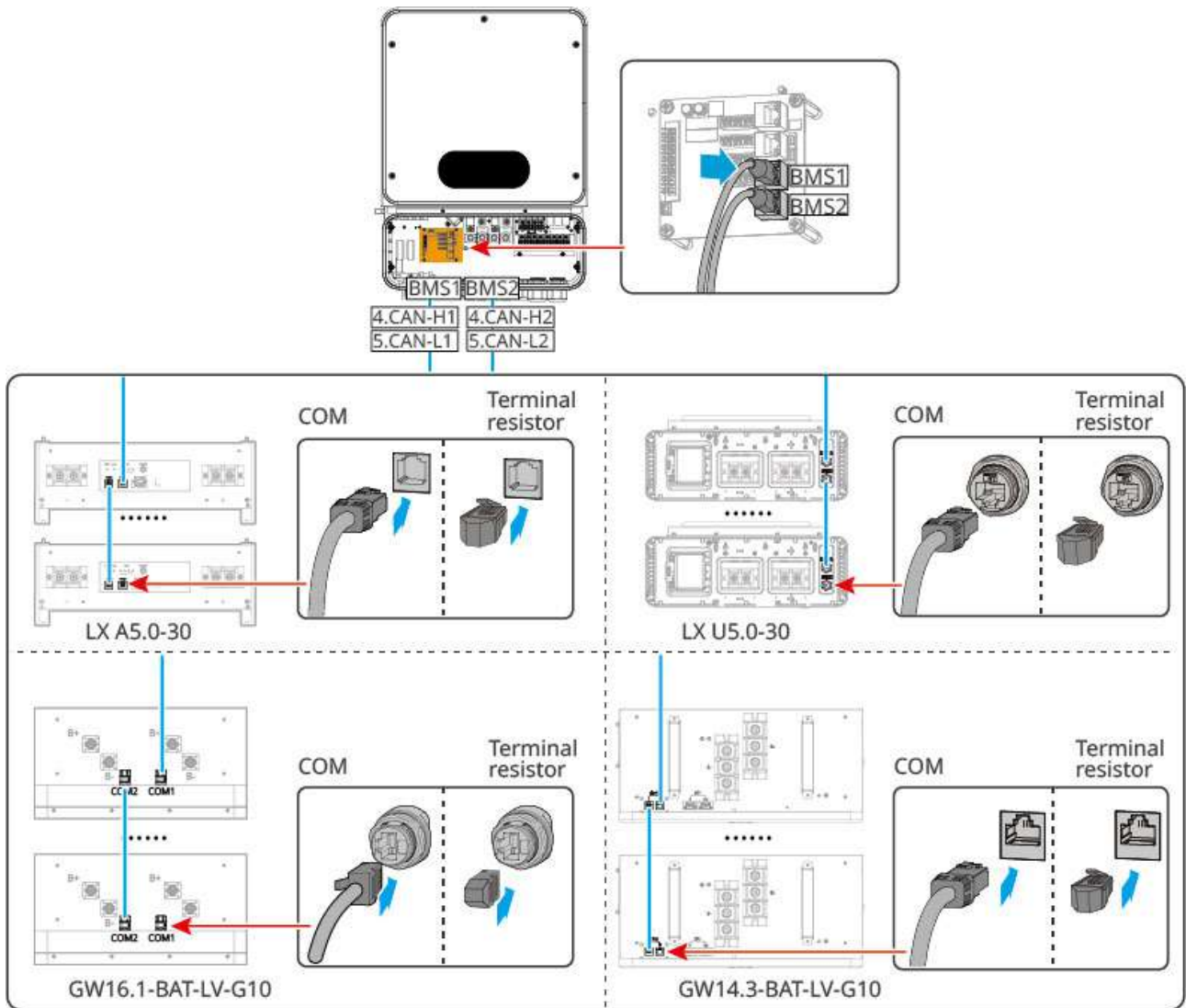

ETL10ELC0014

NOTICE

- When connecting the lead-acid battery temperature sensor cable, it is recommended to connect the temperature sensor cable to a location with poor heat dissipation. For example: when lead-acid batteries are placed side by side, fix the sensor to the lead-acid battery located in the middle.
- To better protect the battery cells, the temperature sampling cable must be installed, and it is recommended to place the battery in a well-ventilated environment.

Lead-acid battery communication schematic:

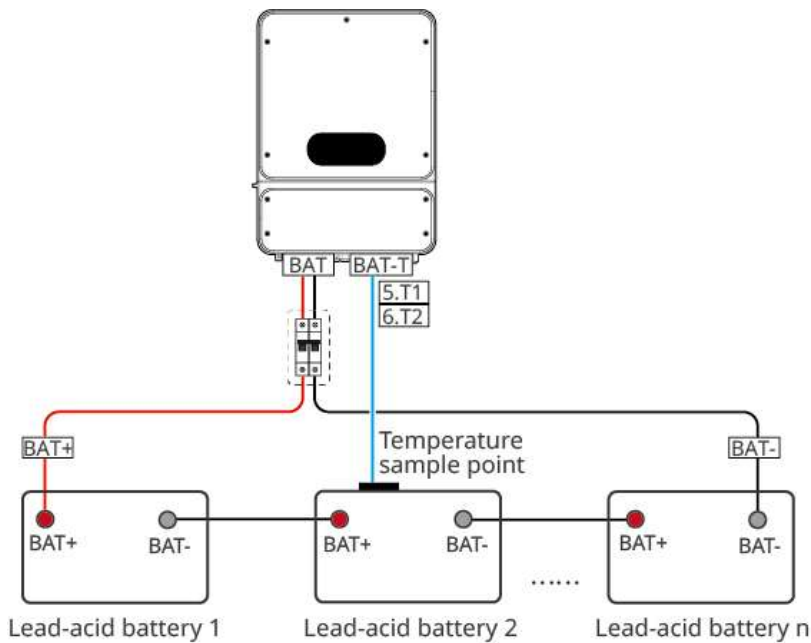

ETL10ELC0013

5.9 Connecting the Meter Cable

NOTICE

- Ensure the CT connection direction and phase sequence are correct; otherwise, monitoring data may be inaccurate.
- Ensure all cables are connected correctly, securely fastened, and not loose. Improper wiring may lead to poor contact or damage to the meter.
- In areas with lightning risks, if the meter cable length exceeds 10m and the cable is not routed using a grounded metal conduit, it is recommended to install external lightning protection devices.
- The outer diameter of the AC power line must be smaller than the CT's aperture to ensure the AC power line can pass through the CT.
- To ensure the CT's current detection accuracy, the recommended CT cable length should not exceed 30m.
- Do not use network cables as CT cables, as excessive current may cause damage to the meter.
- The CTs provided by the equipment manufacturer may vary slightly in size and appearance depending on the model, but the installation and wiring methods are the same.

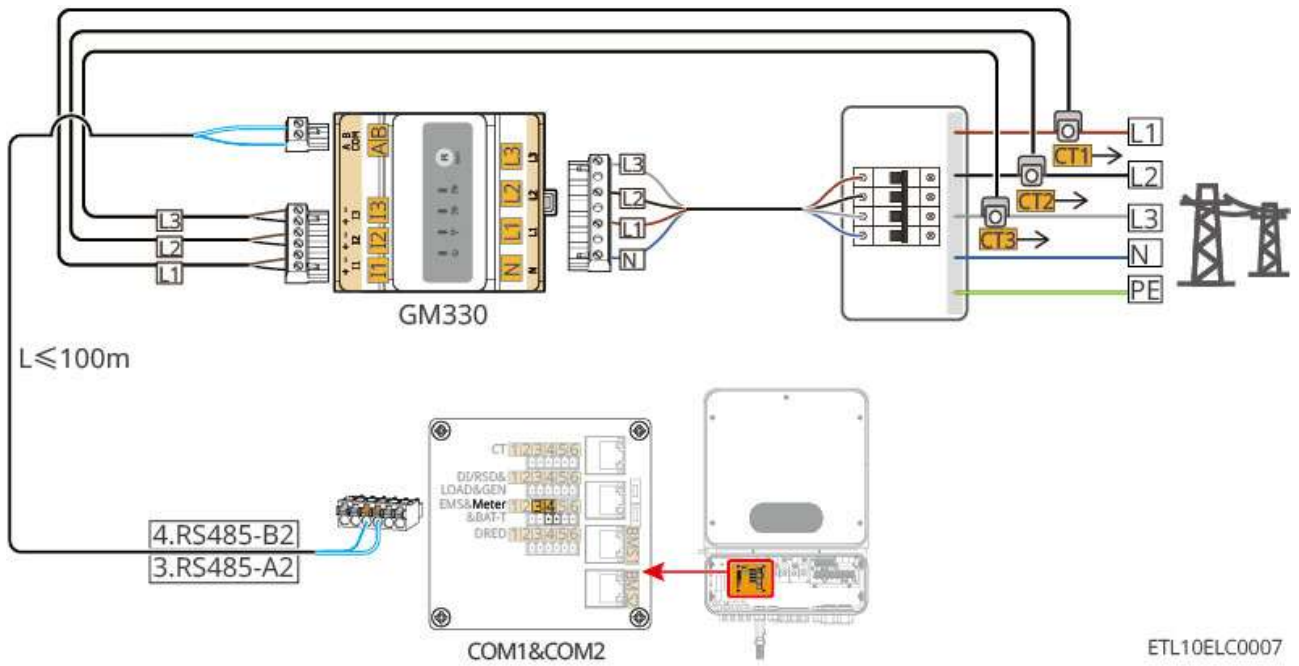

Wiring Steps

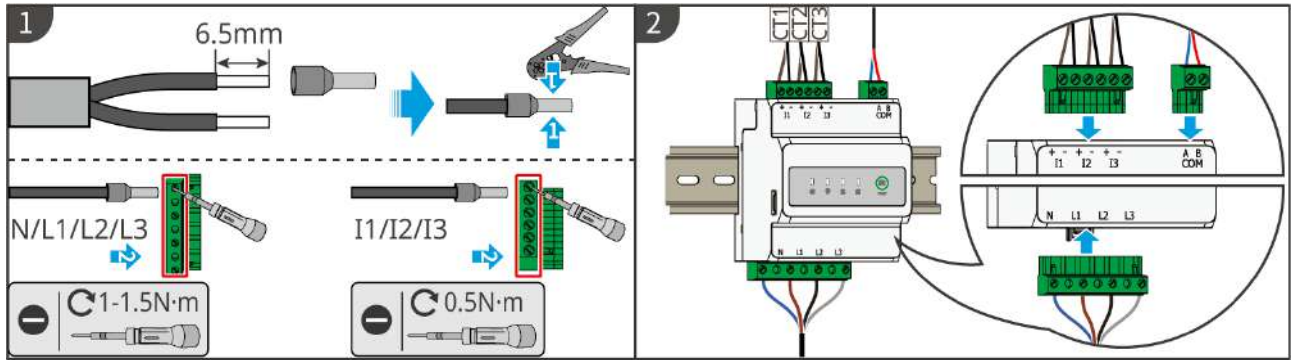

GMK10ELC004

Installing the CT (Type One)

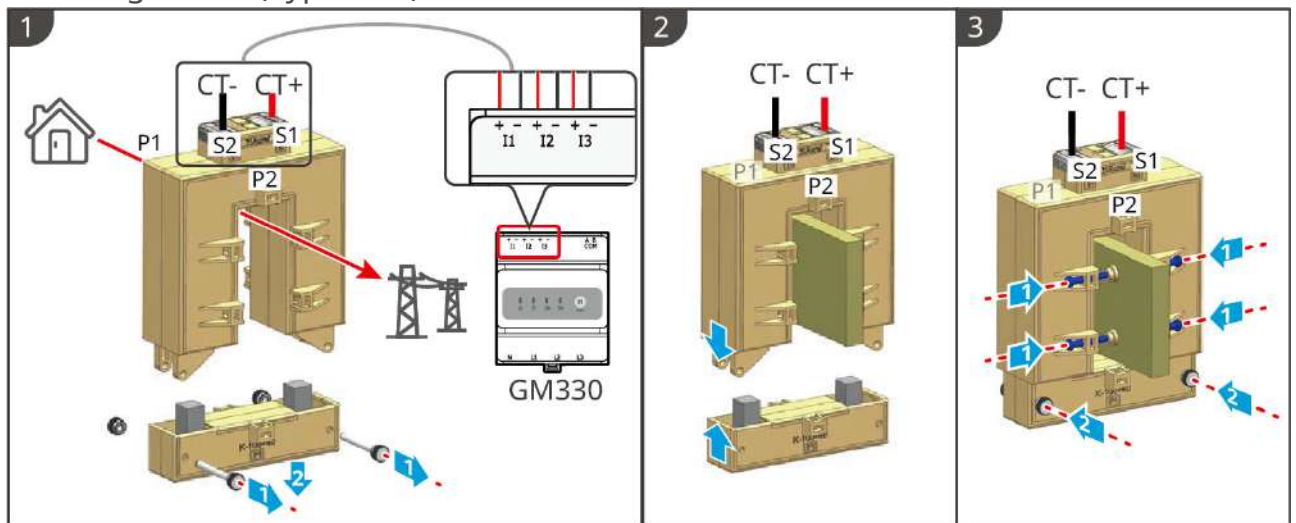

GMK10ELC006

Installing the CT (Type Two)

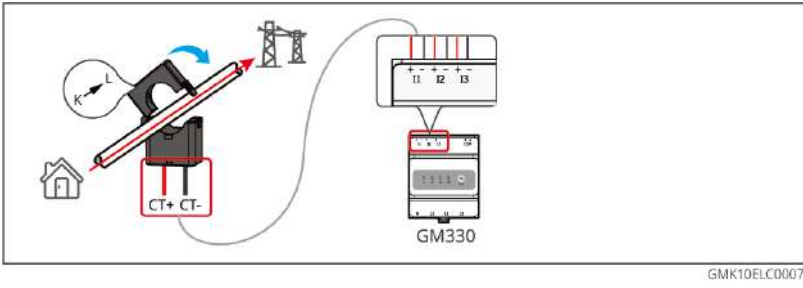

5.10 Connecting the Inverter Communication Cable

NOTICE

- To ensure the meter and CT function properly, please ensure the following:
 - Ensure the CT is connected to the matching phase line: CT1 to L1, CT2 to L2, and CT3 to L3.
 - Connect the CT according to the direction indicated on the meter. Reversed connection may cause a CT reverse fault.
 - When replacing or maintaining the CT later, use the "Meter/CT Auxiliary Detection" function in the App to allow the Inverter to readapt to the CT sampling current direction.
- When using the built-in meter, please use the CTs shipped with the unit.
- If the Inverter is not connected to a DRED device or a remote shutdown device, do not enable this function in the App, otherwise the Inverter will not be able to operate on-grid.
- In a parallel system, to implement DRED or RCR functions, only connect the DRED or RCR communication cable to the master Inverter.
- To maintain the Inverter's waterproof rating, do not remove the waterproof plugs from unused communication ports on the Inverter.
- Specifications for dry contact signals connected to the Inverter's DO signal communication port: Max \leq 24Vdc, 1A.
- The Inverter's communication functions are optional. Please select based on actual usage scenarios.
- The Inverter supports connecting to a phone or WEB interface via 4G, Bluetooth, WiFi, or LAN to set device parameters, view operation information and error messages, and stay informed about system status.
- In a single-unit system, the installation of a WiFi/LAN Kit-20, 4G Kit-CN-G20, or 4G Kit-G20 smart communication stick is supported.
- In a parallel system, both master and slave Inverters require the installation of either a WiFi/LAN Kit-20 or a 4G Kit-CN-G20.
- When using the 4G Kit-G20:
 - If parallel system networking is required, please contact GoodWe to purchase a WiFi/LAN Kit-20.
 - Connection to third-party monitoring platforms is not supported.
- The 4G Kit-CN-G20 and 4G Kit-G20 are LTE single-antenna devices suitable for application scenarios with lower data transmission rate requirements.

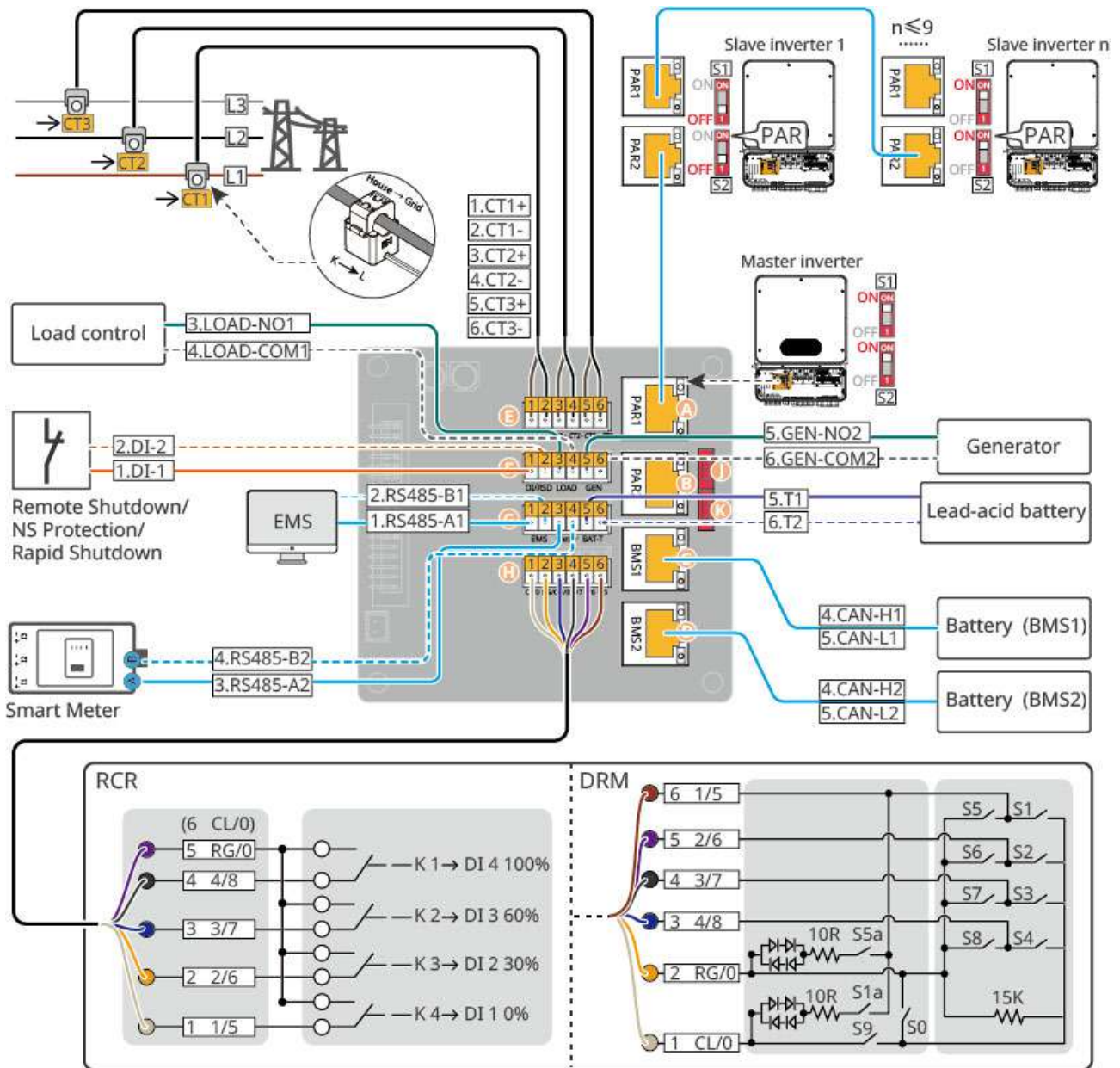

ETL10ELC0027

Communication Function Description

Port (Silkscreen)	Function	Description
A PAR1	Parallel Communication on Port 1	Parallel communication port. Please use CAT 5E or higher standard network cable with an RJ45 connector.

Port (Silkscreen)		Function	Description
B	PAR2	Parallel Communication Port 2	
C	BMS 1	Battery BMS Communication	When connecting a lithium-ion battery, used to connect the BMS communication cable of the battery system, supporting CAN signal communication.
D	BMS 2		
E	CT	CT Connection Port	The CT communication cable needs to be connected only when using the inverter's built-in meter.
F	DI	Remote Shutdown / NS protection / Rapid Shutdown	<ul style="list-style-type: none"> • For connecting an external Remote Shutdown or local NS protection device, disabled by default. • In a Rapid Shutdown system, the rapid shutdown transmitter and receiver work together to achieve rapid system shutdown. The receiver maintains module output by receiving signals from the transmitter. The transmitter can be external or built into the inverter. In an emergency, enabling an external trigger device stops the transmitter, thereby shutting down the modules.
	LOAD	load control	<ul style="list-style-type: none"> • Supports connection of dry contact signals to implement functions such as load control. DO contact rating is 24V DC@1A, NO/COM normally open contacts. • Supports SG Ready heat pump connection, controlling the heat pump via dry contact signals.

Port (Silkscreen)		Function	Description
	GEN	Generator Control Port	Supports connection of generator control signals to control generator start/stop. Generator connection is not supported in microgrid scenarios.
G	EMS	EMS	Connect to a third-party EMS device for energy control.
	METER	Meter Connection Port	Use RS485 communication to connect an external smart meter.
	BAT-T	Lead-acid Temperature Sampling Port	Used to connect the temperature sensor cable for lead-acid battery temperature measurement.
H	DRED	RCR or DRED Function Connection Port	<ul style="list-style-type: none"> • RCR (Ripple Control Receiver): Provides an RCR signal control port to meet grid dispatch requirements in European regions. • DRED (Demand Response Enabling Device): Provides a DRED signal control port to meet DERD certification requirements in regions such as Australia.
J	SW1	Parallel DIP Switch	In multi-unit parallel scenarios, set the parallel DIP switch of the first and last inverters to the ON position, and set the switches of other inverters to the OFF position.
K	SW2		

Method for Connecting the Communication Cable

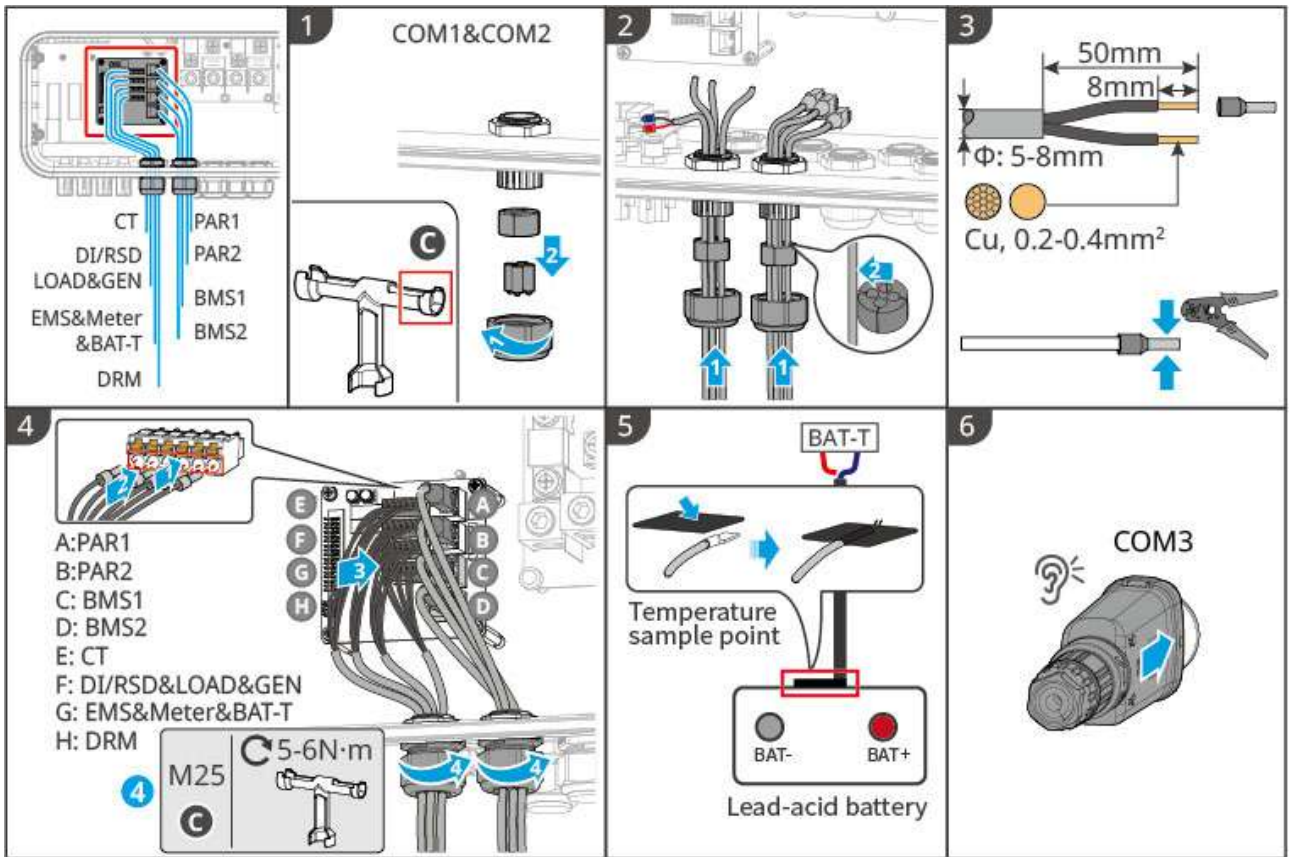

ETL10ELC0005

5.11 Installing the Inverter Enclosure Lower Cover

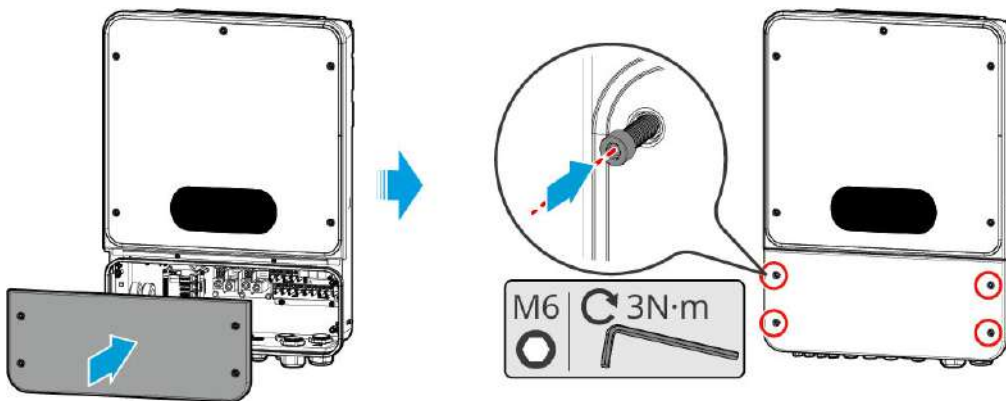

ETL10INT0004

5.12 Install the Battery Cover

5.12.1 LX A5.0-30

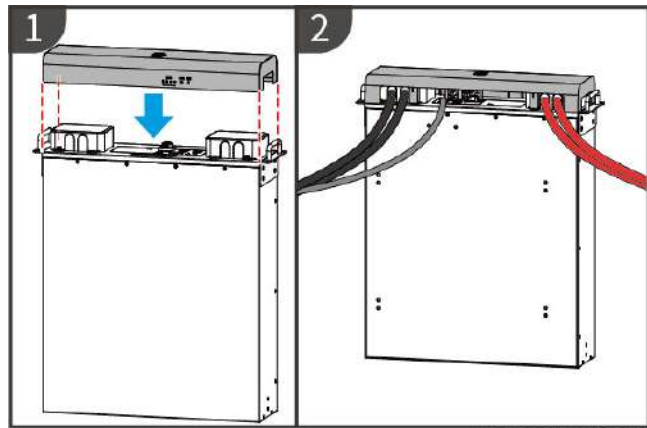

LXA30INT0006

5.12.2 GW14.3-BAT-LV-G10

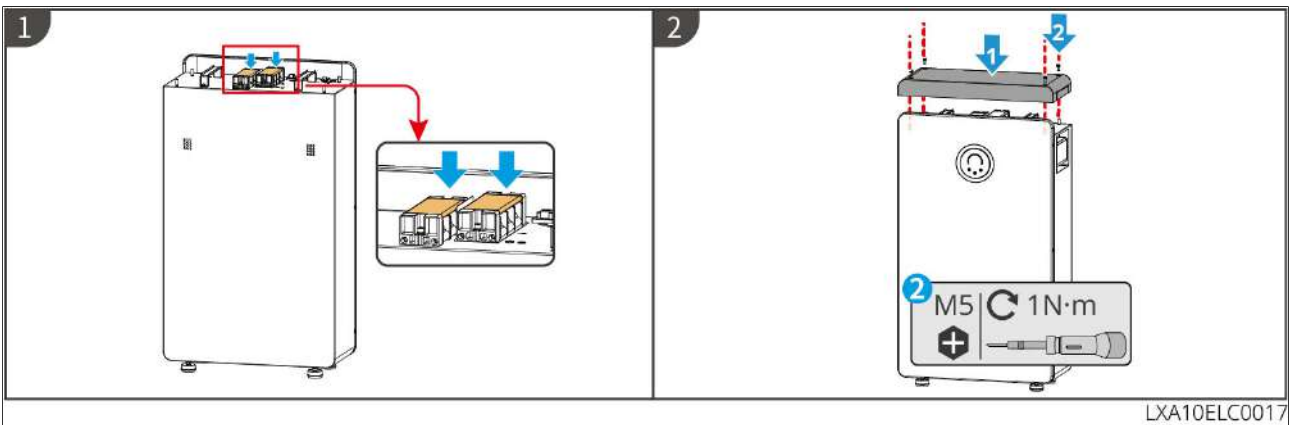

LXA10ELC0017

5.12.3 LX U5.0-30

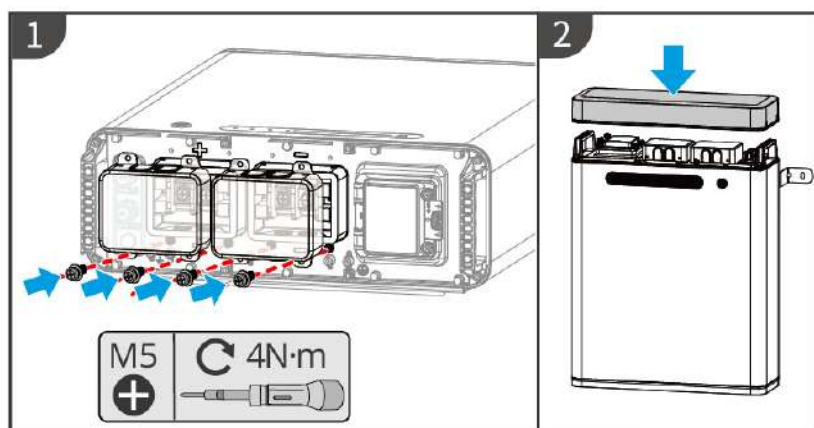

LXU30INT0006

5.12.4 GW16.1-BAT-LV-G10

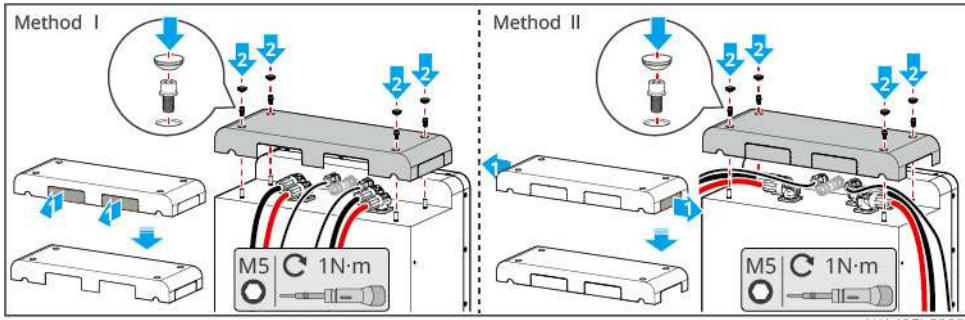

LXA40ELC0009

6 System Commissioning

6.1 Check Before Power ON

No.	Inspection Item
1	The equipment is securely installed, the installation location facilitates operation and maintenance, the installation space allows for ventilation and heat dissipation, and the installation environment is clean and tidy.
2	The PE cable, DC cable, AC cable, Communication cable, and terminal resistor are connected correctly and securely.
3	Cable bundling meets routing requirements, is properly distributed, and shows no damage.
4	For unused cable holes and ports, ensure they are securely connected using the terminals provided with the accessories and have been sealed.
5	Ensure that used cable holes have been properly sealed.
6	The voltage and frequency at the inverter grid connection point comply with grid connection requirements.

6.2 Power ON



- Battery black start function: When there is no PV power generation in the photovoltaic system and the grid is abnormal, if the inverter cannot work normally, the battery black start function can be used to force the battery to discharge and start the inverter. The inverter can then enter off-grid mode operation, supplying power to the load from the battery.
- After the battery system is started, please ensure that the communication between the inverter and the battery system is normal within 15 minutes. If the inverter and the battery system cannot communicate normally, the battery system switch will automatically disconnect, cutting off power to the battery system.
- When multiple batteries are connected in parallel in the system, starting any one battery can start all batteries.
 - GW14.3-BAT-LV-G10: After the batteries are powered down and then powered up again, it is necessary to restart each battery one by one or let them sit idle for 15 minutes and then start any one battery to start all batteries.

power on

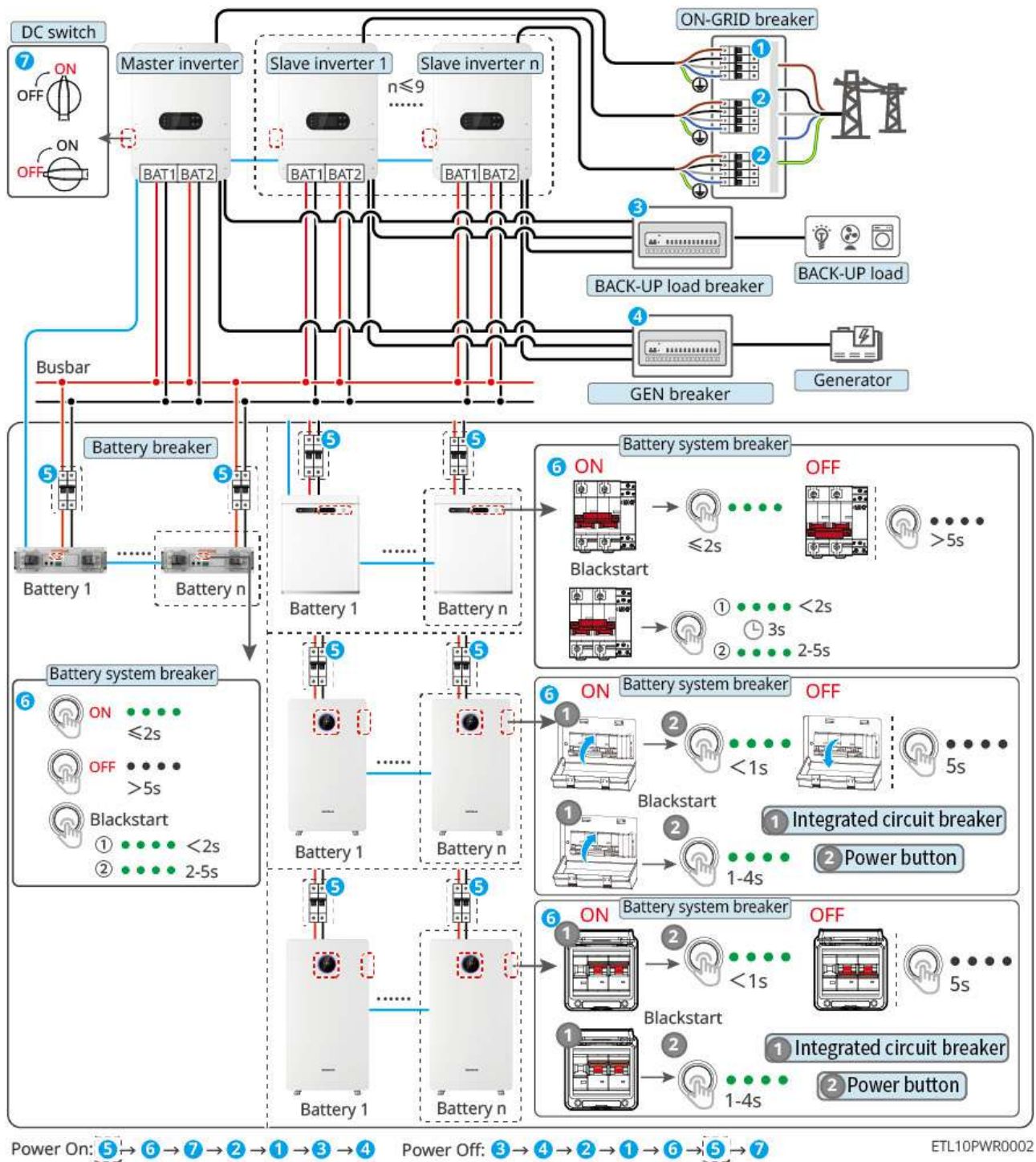

1. (Depending on local regulations) Close the switch between the inverter and the battery.
2. Start the battery system.
 - a. GW14.3-BAT-LV-G10, LX U5.0-30, GW16.1-BAT-LV-G10: Close the battery system integrated circuit breaker and briefly press the multifunction breaker button for less than

1 second.

b. LX A5.0-30: Press the battery system switch for less than or equal to 2 seconds.





3. Close the DC switch of the inverter.
4. (Optional) Close the ON-GRID circuit breaker of the slave inverter.
5. Close the main inverter ON-GRID circuit breaker.
6. Close the BACK-UP circuit breaker.
7. (Optional) Close the GEN circuit breaker.









Battery Black Start

1. Close the battery system switch.
2. Start the battery:
 - a. LX A5.0-30, LX U5.0-30: Briefly press the battery multifunction button <2 seconds, then press and hold for 2-5 seconds to start the battery system. The battery forces discharge to activate the inverter.
 - b. GW14.3-BAT-LV-G10, GW16.1-BAT-LV-G10: Press and hold the battery multifunction button for 1-4 seconds to start the battery system. The battery forces discharge to activate the inverter.
3. Close the DC switch of the inverter.
4. (Optional) Close the ON-GRID circuit breaker of the slave inverter.
5. Close the main inverter ON-GRID circuit breaker.
6. Close the BACK-UP circuit breaker.
7. (Optional) Close the GEN circuit breaker.

6.3 Indicators





6.3.1 Inverter Indicators



Indicator	Status	Description
		Inverter is starting up and in self-check mode
		Inverter is operating normally, either grid-connected for power generation or in off-grid mode
		BACK-UP output overload
		System fault

Indicator	Status	Description
	_____	LCD ON: Inverter is powered on and in standby mode LCD OFF: Inverter is powered off
		Grid is abnormal, inverter BACK-UP port power supply is normal
		Grid is normal, inverter BACK-UP port power supply is normal
	_____	No power supply at the BACK-UP port
		Inverter monitoring module is resetting
		No connection established between the inverter and the communication terminal
		Communication fault between the communication terminal and the cloud server
		Inverter monitoring is normal
	_____	Inverter monitoring module is not started





6.3.2 Battery Indicators



6.3.2.1 LX A5.0-30

indicator		System Status
	SOC indicator has no green display	SOC=0%
	The first SOC indicator displays green	$0% < SOC \leq 25%$
	The second SOC indicator displays green	$25% < SOC \leq 50%$
	The third SOC indicator displays green	$50% < SOC \leq 75%$

indicator		System Status
	The fourth SOC indicator displays green	$75\% < \text{SOC} \leq 100\%$
 RUN indicator	Green steady on	Battery system is operating normally
	Green blinking once per second	Battery system is in standby state
	Green blinking three times per second	PCS Comm Loss
	slow blinking	After an alarm occurs in the battery system, it will perform self-check. Wait for the self-check to complete, then switch to normal operation state or fault state.
 ALM indicator	Red steady on	Determine the fault type based on the display form of the SOC indicator, and handle it according to the methods recommended in the fault handling chapter.

6.3.2.2 LX A5.0-30, LX U5.0-30

Indicator		System Status
	SOC indicator shows no green light	$\text{SOC}=0\%$
	The first SOC indicator shows green	$0\% < \text{SOC} \leq 25\%$
	The second SOC indicator shows green	$25\% < \text{SOC} \leq 50\%$
	The third SOC indicator shows green	$50\% < \text{SOC} \leq 75\%$
	The fourth SOC indicator shows green	$75\% < \text{SOC} \leq 100\%$
	Solid green	Battery system operating normally





Indicator		System Status
 RUN Lamp	Green blinking at 1 time/s	Battery system is in standby state
	Green blinking at 3 times/s	PCS Comm Loss
	Slow blinking	The battery system will perform a self-check after an alarm occurs. Wait for the self-check to complete, then transition to normal operation or fault state.
 ALM Lamp	Solid red	Determine the fault type based on the display pattern of the SOC indicator, and handle it according to the methods recommended in the fault handling section.

6.3.2.3 GW14.3-BAT-LV-G10



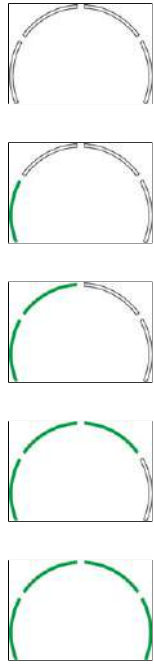



Normal Status

Indicat or Name	Indicator Status		Corresponding Other Light Status	System Status
SOC Indicator		SOC indicator green steady on	/	SOC=0% $0% < SOC \leq 25%$ $25% < SOC \leq 50%$ $50% < SOC \leq 75%$ $75% < SOC \leq 100%$

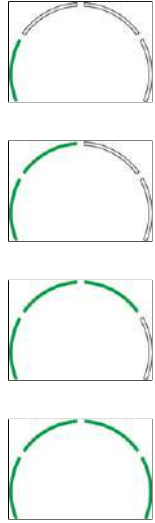
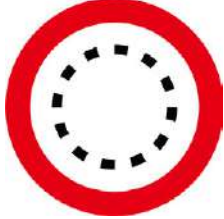
Indicator or Name	Indicator Status		Corresponding Other Light Status	System Status
		SOC indicator green blinking		Battery system is in discharge state
Run Indicator + Touch Key		White steady on	 Blue-purple breathing light	System operating normally
		White blinking	 Blue-purple running light	System preparing
Communication Light		White steady on	/	PCS communication normal





Abnormal Status

Indicator or Name	Indicator Status	Corresponding Other Indicator Status	System Status
SOC Indicator	 <p>SOC indicator solid green</p>	 red blinking  off  solid red	Determine the type of fault that has occurred based on the display pattern of the SOC indicator, and handle it according to the methods recommended in the fault handling section.
Comm Indicator	 <p>Off</p>	/	PCS Comm Loss
System Alarm Indicator	 <p>Solid white</p>	/	System alarm and undervoltage fault levels 2, 3, 4

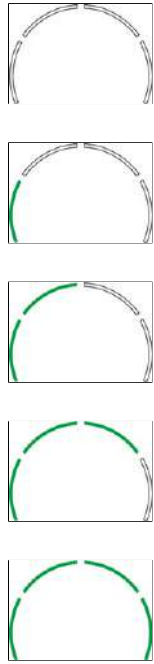

6.3.2.4 GW16.1-BAT-LV-G10



Normal State



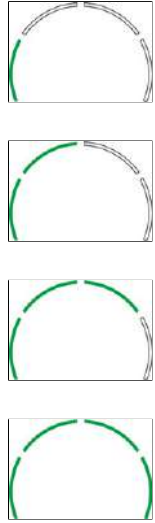
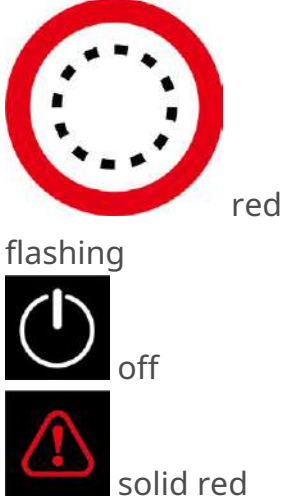

Indicator or Name	Indicator Status		Corresponding Other Light Status	System Status
SOC Indicator		SOC indicator green steady on	/	SOC=0% 0% < SOC ≤ 25% 25% < SOC ≤ 50% 50% < SOC ≤ 75% 75% < SOC ≤ 100%
		SOC indicator green blinking		Battery system is in discharge state
Run Indicator + Touch Key		White steady on	 Blue-purple breathing light	System operating normally
		White blinking	 Blue-purple chasing lights	System preparing
Communication Light		White steady on	/	PCS communication normal

Abnormal State

Indicator or Name	Indicator Status	Corresponding Other Indicator Status	System Status
SOC Indicator	 <p>SOC indicator solid green</p>	 <p>flashing red off solid red</p>	Determine the type of fault that has occurred based on the display pattern of the SOC indicator, and handle it according to the methods recommended in the Fault Handling section.
Comm Indicator	 <p>Off</p>	/	PCS Comm Loss
System Alarm Indicator	 <p>Solid white</p>	/	System Alarm and Undervoltage Fault Levels 2, 3, 4

6.3.3 Smart Meter Indicator

GM330





Type	Status	Description
Power Light 	Constantly lit	The meter is powered on, no RS485 communication
	Blinking	The meter is powered on, RS485 communication normal
	Off	The meter is powered off
Communication Light 	Off	Reserved
	Blinking	Press the Reset button for ≥5s, power light and buy/sell light blink: meter reset
Buy/Sell Light 	Constantly lit	buy power from the grid
	Blinking	Sell power to the grid
	Off	Not buying or selling power
	Reserved	







6.3.4 Smart Dongle Indicator

- WiFi/LAN Kit-20

NOTICE

- After double-clicking the Reload button to enable Bluetooth, the communication indicator light will switch to a single-flash state. Please connect to the SolarGo APP within 5 minutes, otherwise Bluetooth will automatically turn off.
- The communication indicator light's single-flash state only occurs after double-clicking the Reload button to enable Bluetooth.









Indicator	Status	Description
Power Light 		Constantly on: The Smart Communication Stick is powered on.
		Off: The Smart Communication Stick is not powered on.
		Constantly on: Communication is normal in WiFi mode or LAN mode.

Indicator	Status	Description
Communi- cation Light 		Single blink: The Smart Communication Stick's Bluetooth signal is on, waiting to connect to the SolarGo app.
		Two blinks: The Smart Communication Stick is not connected to the router.
		Four blinks: The Smart Communication Stick communicates normally with the router but is not connected to the server.
		Six blinks: The Smart Communication Stick is identifying connected devices.
		Off: The Smart Communication Stick is undergoing a software reset or is not powered on.

Indicator	Color	Status	Description
LAN Port Communic- ation Light 	Green	Steady on	100Mbps wired network connection is normal.
		Off	<ul style="list-style-type: none"> • Network cable is not connected. • 100Mbps wired network connection is abnormal. • 10Mbps wired network connection is normal.
	Yellow	Steady on	10/100Mbps wired network connection is normal, with no communication data being sent or received.
		Flashing	Communication data is being sent or received.
		Off	Network cable is not connected.

Button	Description
Reload	Hold for 0.5~3 seconds, the Smart Communication Stick will reset.
	Hold for 6~20 seconds, the Smart Communication Stick will restore factory settings.
	Double-click quickly to enable the Bluetooth signal (maintained for only 5 minutes).

• 4G Kit-CN-G20 & 4G Kit-G20

Indicator	Status	Description
		Steady on: The smart communication stick is powered on.
		Off: The smart communication stick is not powered on.
		Steady on: The smart communication stick is connected to the server, communication is normal.
		Double flash: The smart communication stick is not connected to the communication base station.
		Quadruple flash: The smart communication stick is connected to the communication base station but not to the server.
		Sextuple flash: Communication between the smart communication stick and the inverter is disconnected.
		Off: The smart communication stick is undergoing a software reset or is not powered on.

Button	Description
RELOAD	Double-click to enable Bluetooth broadcast for the Smart Communication Stick. [1]
	Hold for 0.5~3 seconds to restart the Smart Communication Stick.
	Hold for 6~20 seconds to restore the Smart Communication Stick to factory settings.

[1] Applies only to 4G Kit-G20.

7 System Commissioning

7.1 Configuration via LCD

7.1.1 LCD Overview

Through the LCD screen, users can:

1. View device operation data, software version, alarm information, etc.
2. Set parameters, safety regulation regions, anti-reverse flow, etc.

NOTICE

The LCD display interface may vary depending on the device model and the safety regulation settings for the country. Please refer to the actual interface display.







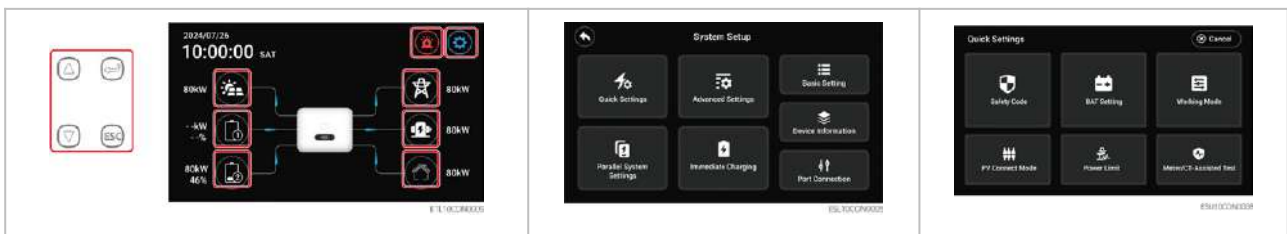



LCD Interface Overview

The LCD supports both touch and key operation.

General Status









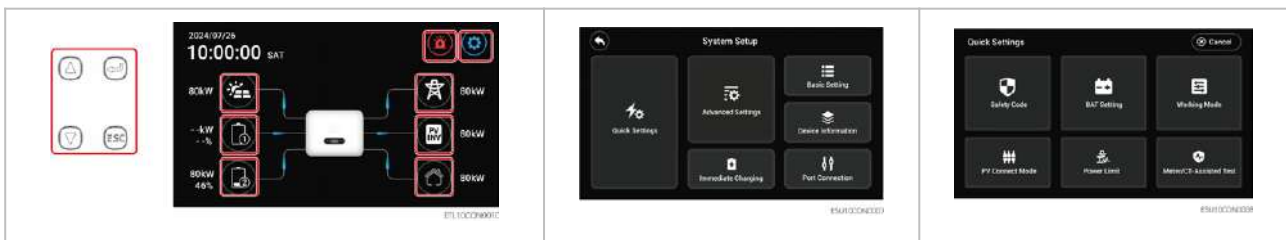







Name/Icon	Description
	Up
	Down
	Confirm

Name/Icon	Description
	<ul style="list-style-type: none"> Short press: Exit page Press  and  together for 5s: Restart the device
	Used to view PV current, voltage, power generation, and other information
	Used to view battery model, status, and other information <ul style="list-style-type: none"> GW5K-ET-L-G10, GW6K-ET-L-G10, GW8K-ET-L-G10, GW10K-ET-L-G10, GW12K-ET-L-G10, GW12K-ET-LL-G10 display one battery string GW15K-ET-L-G10, GW20K-ET-L-G10 display two battery strings
	Used to view the inverter's fault codes
	Used to enter the inverter's setup interface
	Used to view grid status information
	Used to view generator status
	Used to view the inverter's load information
	Return to the main interface
Cancel	Return to the previous menu
Next	Enter the next setup page
Back	Return to the previous setup page

Microgrid Status



Name/Icon	Description
	Up
	Down
	Confirm
	<ul style="list-style-type: none"> • Short Press: Exit page • Press and hold  and  simultaneously for 5s: Restart the device
	Used to view PV current, voltage, power generation, and other information.
	<p>Used to view battery model, status, and other information.</p> <ul style="list-style-type: none"> • GW5K-ET-L-G10, GW6K-ET-L-G10, GW8K-ET-L-G10, GW10K-ET-L-G10, GW12K-ET-L-G10, GW12K-ET-LL-G10 display one battery string. • GW15K-ET-L-G10, GW20K-ET-L-G10 display two battery strings.
	Used to view the inverter's fault codes.
	Used to enter the inverter's settings interface.
	Used to view grid status information.
	Used to display the status of the grid-tied inverter.
	Used to view the inverter's load information.
	Return to the main interface.
Cancel	Return to the previous menu.
Next	Enter the next settings page.

Name/Icon	Description
Back	Return to the previous settings page.

LCD Settings Interface Structure

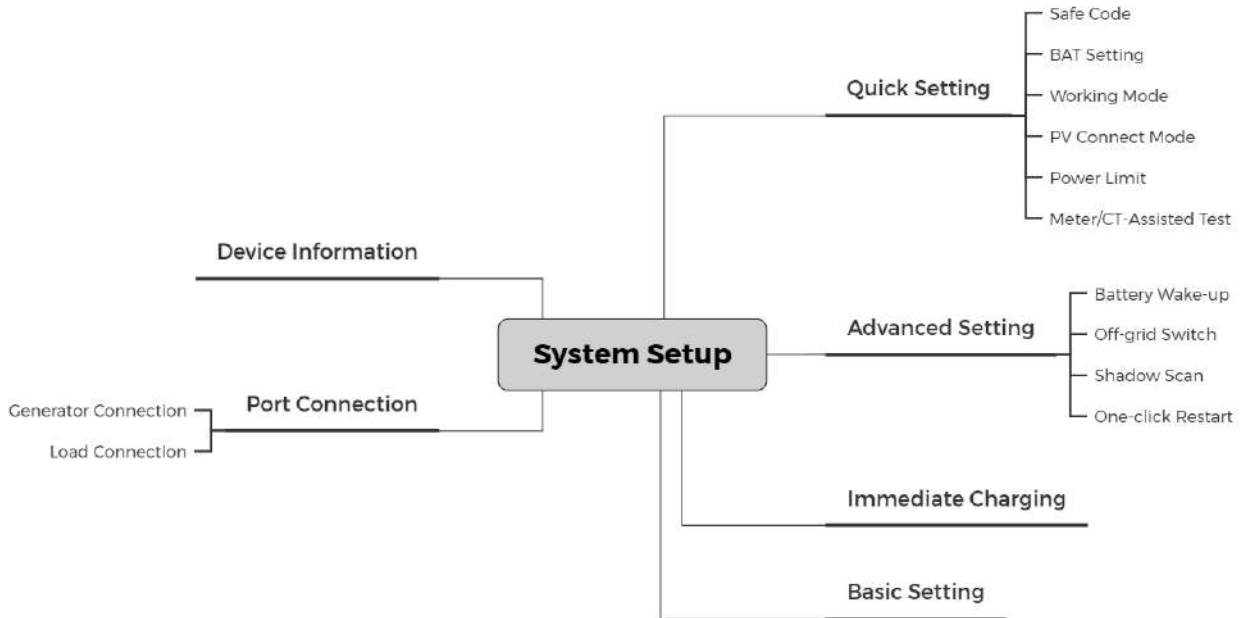

7.1.2 Parallel System Settings

1. From the main interface, click  > Parallel System Settings to enter the parameter setting interface.
2. Based on the actual wiring of the inverter, set it as Master, Slave, or Standalone.
3. After completing the settings, click Confirm. The interface will display "Confirm OK" indicating the parameter settings are successful.

NOTICE

Please ensure that you click Confirm on each page to ensure the parameters take effect; otherwise, the system will run with default parameters.

Set Master Inverter Parameters

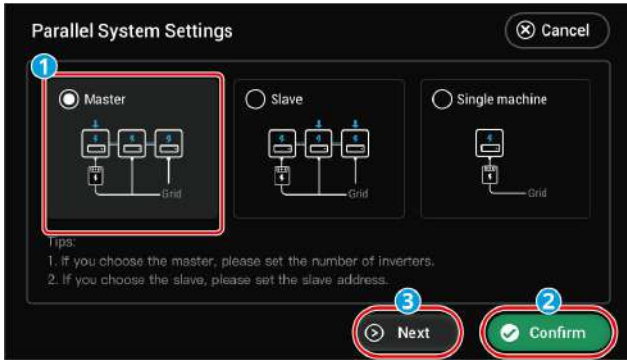

ESL10CON0005

Set Slave Inverter Parameters

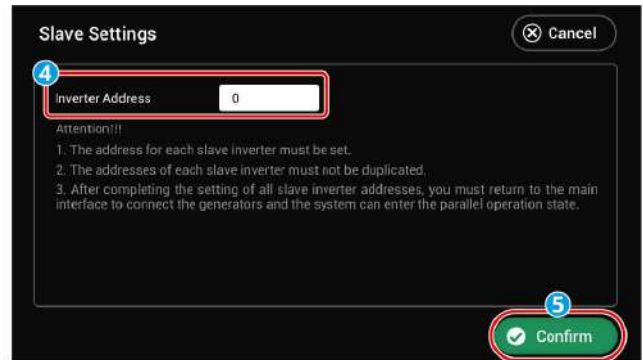
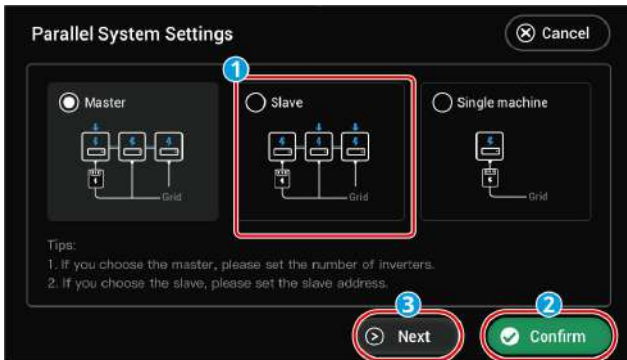

ESL10CON0007

Set Standalone

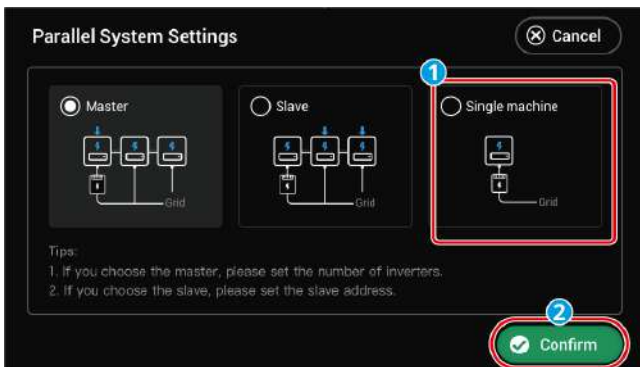

ESL10CON0008

7.1.3 Quick Settings

Set Safety Code

1. Through the main interface, click  > Quick Settings > Safe Code to enter the parameter setting interface.
2. Please select the corresponding safety code according to the country or region where the device is located.
3. After setting is complete, please click Confirm. After the interface prompts Confirm

OK, the parameter setting is successful.

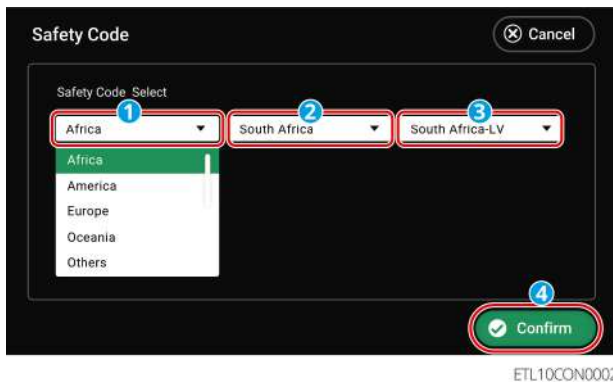

Set Battery Parameters

1. Through the main interface, click  > Quick Settings > BAT Setting to enter the parameter setting interface.
2. Please set parameters according to the actual situation.
3. After setting is complete, please click Confirm. After the interface prompts Confirm OK, the parameter setting is successful.

NOTICE

Please ensure that on each page, you click Confirm to make the parameters take effect; otherwise, the system will run with default parameters.

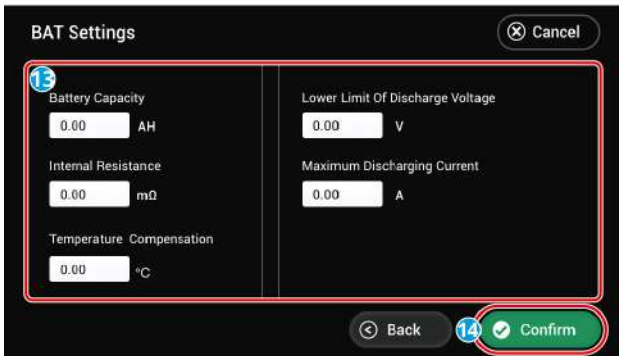
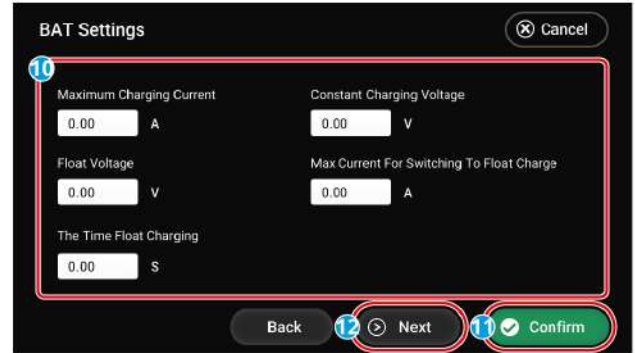
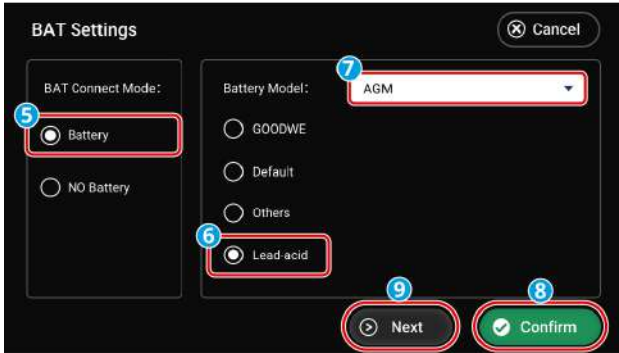
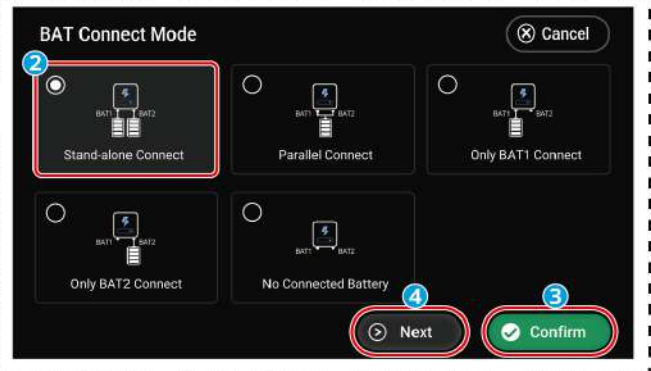
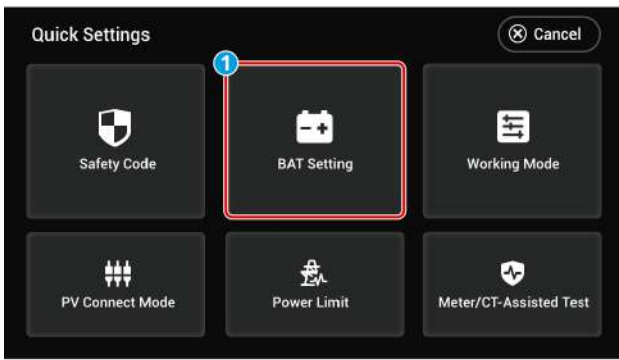

ETL10CON0003

Basic Parameter Settings

BAT Connection Mode	Type	Description
Battery	GOODWE	If a GOODWE brand lithium battery is connected in the system, select GOODWE and choose the correct model. If the actual GOODWE battery model used is not in the options, please use the App settings.

	Default	If the third-party lithium battery model connected in the system is not in this list, please select according to the actual situation: <ul style="list-style-type: none"> • Lithium 50Ah • Lithium 100Ah
	Others	If the third-party lithium battery model connected in the system is in this list, please select the correct model according to the actual situation.
	Lead acid	If a lead-acid battery is connected in the system, select Lead acid and choose the correct lead-acid type. Currently, GEL, AGM, and Flooded are supported.
NO Battery	No battery is connected in the system.	
BAT Setting	Set according to the battery actually connected in the system.	

Lithium Battery Parameter Settings

Parameter Name	Description
SOC Protection	Enable or disable the SOC protection function.
Depth Of Discharge (On-Grid)	The maximum discharge depth protection point for the battery when the inverter is operating in on-grid mode.
Depth Of Discharge (Off-Grid)	The maximum discharge depth protection point for the battery when the inverter is operating in off-grid mode.
Backup SOC Holding	To ensure the battery SOC is sufficient to maintain normal system operation during off-grid mode, the system charges the battery via grid or PV to the set SOC protection value when operating in on-grid mode.

Lead-acid Battery Parameter Settings

Parameter Name	Description
Maximum Charging Current	

Constant Charging Voltage	Battery charging defaults to constant charging mode; The maximum charging voltage and maximum charging current in this mode need to be set; please configure according to the battery technical specifications.
Float Voltage	When the battery charging current is less than the Maximum Current For Switch To Float Charge and this condition persists for the duration of The Time Float Charging, the battery charging status switches from constant charging mode to float charging mode. Float Voltage is the maximum battery charging voltage in float charging mode. Please configure according to the battery technical specifications.
The Time Float Charging	
Maximum Current For Switch To Float Charge	
Battery Capacity	Set the battery capacity according to the parameters of the actually connected battery.
Internal Resistance	The resistance present within the battery. Please configure according to the battery technical specifications.
Temperature Compensation	By default, when the temperature exceeds 25°C, for every 1°C increase, the upper limit of the charging voltage decreases by 3mV. Please configure according to the actual battery technical specifications.
Lower Limit Of Discharge Voltage	Please configure according to the battery technical specifications.
Maximum Discharging Current	Please configure according to the battery technical specifications. The greater the discharge current, the shorter the battery operating time.

Set Working Mode

1. Through the main interface, click  > Quick Settings > Working Mode to enter the parameter setting interface.
2. Please set parameters according to the actual situation.
3. After setting is complete, please click Confirm. After the interface prompts Confirm OK, the parameter setting is successful.

NOTICE

Please ensure you click Confirm on each page for the parameters to take effect; otherwise, the system will run with default parameters.

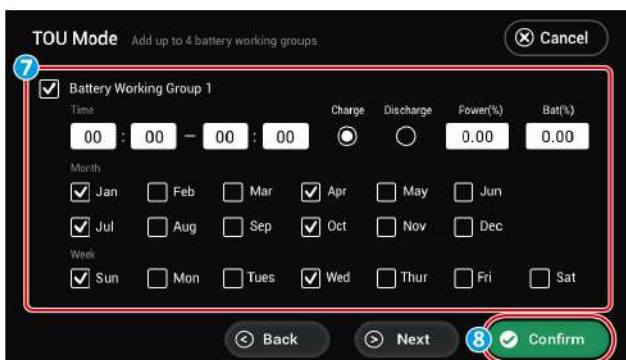
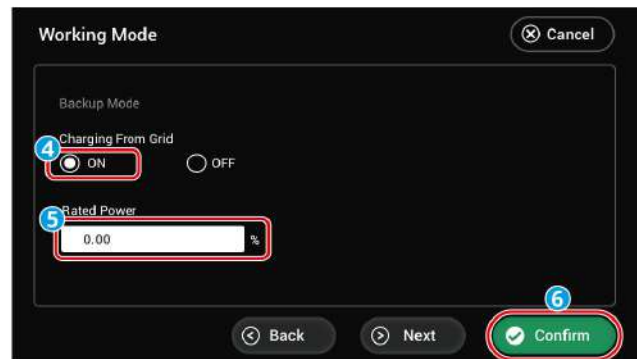
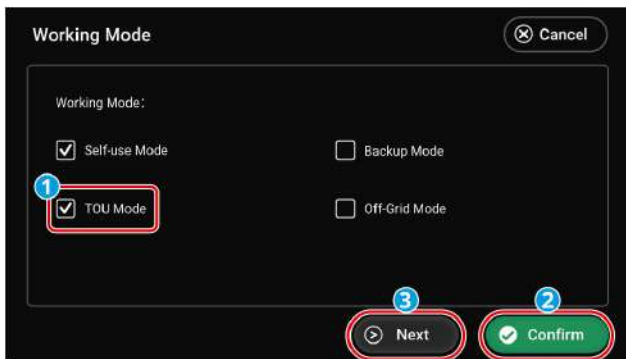

ETL10CON0008

Parameter Name		Description
Self-use Mode		When the working mode is set to Self-use Mode, the Back-up Mode, TOU Mode, and Off-Grid Mode can be enabled simultaneously. Please select according to the actual situation. Working mode priority order: Off-Grid Mode > Back-up Mode > TOU Mode > Self-use Mode.
Back-up Mode	Charging From Grid	Enable this function to allow the system to purchase electricity from the grid.
	Rated Power	The percentage of power relative to the inverter's rated power when purchasing electricity.
TOU Mode	Time	Within the start and end time, the battery charges or discharges according to the set charge/discharge mode and rated power.

	Charge/Discharge	Set to charge or discharge based on actual requirements.
	Power (%)	The percentage of power relative to the inverter's rated power during charging or discharging.
	Bat (%)	Charging stops when the battery level reaches the set SOC. To set the stop SOC for battery discharge, please refer to the 7.2.9.9.2.2.2 Setting Battery Parameters(Page 283) section and configure the Depth of Discharge (On-Grid) and Depth of Discharge (Off-Grid) via the LCD screen.
Off-Grid Mode		In Off-Grid Mode, the inverter disconnects from the grid. The output supplies power only to the BACK-UP Loads, with excess energy charging the battery.

Set PV Connection Mode

1. Through the main interface, click  > Quick Settings > PV Connect Mode to enter the parameter setting interface.
2. Please set parameters according to the actual situation.
3. After setting is complete, please click Confirm. After the interface prompts Confirm OK, the parameter setting is successful.

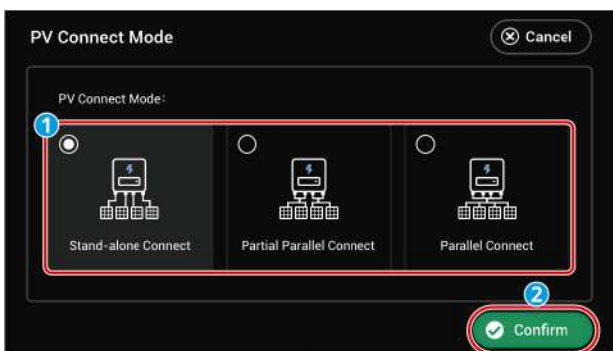

ESU10CON0015

Parameter Name	Description
Stand-alone Connect	Each photovoltaic string is connected to an MPPT port on the inverter side in a one-to-one correspondence.

Partial Parallel Connect	When one photovoltaic string is connected to multiple MPPT ports on the inverter side, while other photovoltaic strings are connected to other MPPT ports on the inverter side.
Parallel Connect	When external photovoltaic strings are connected to the inverter's photovoltaic input ports, one photovoltaic string is connected to multiple photovoltaic input ports.

Set Grid-connected Power Limit

1. Through the main interface, click  > Quick Settings > Power Limit to enter the parameter setting interface.
2. Please set parameters according to the actual situation.
3. After setting is complete, please click Confirm. After the interface prompts Confirm OK, the parameter setting is successful.

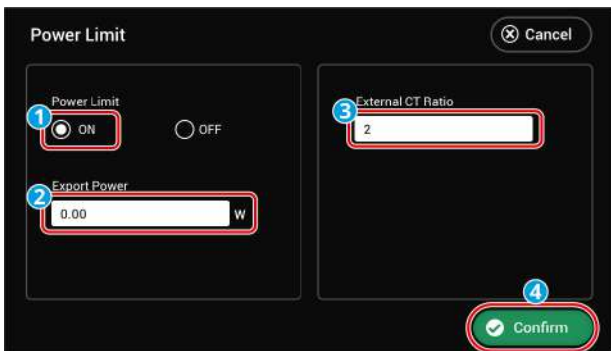

ESU10CON0016

Parameter Name	Description
Power Limit	Enable this function when it is necessary to limit the output power according to the grid standard requirements of certain countries or regions.
Export Power	Set based on the actual maximum power that can be fed into the grid.

External CT Ratio	<p>Set to the ratio of the primary side current to the secondary side current of the external CT.</p> <ul style="list-style-type: none"> • Built-in meter: No need to set the CT ratio. The default CT ratio is 120A/40mA. • GM330: The CT can be purchased from GoodWe or separately. CT ratio requirement: nA/5A <ul style="list-style-type: none"> ◦ nA: CT primary side input current, where n ranges from 200 to 5000. ◦ 5A: CT secondary side output current.
-------------------	--

Meter/CT Auxiliary Detection

1. Through the main interface, click  > Quick Settings > Meter/CT Assisted Test to enter the parameter setting interface.
2. Click Start Test to begin detection. After detection is complete, judge the detection result based on the interface prompt.

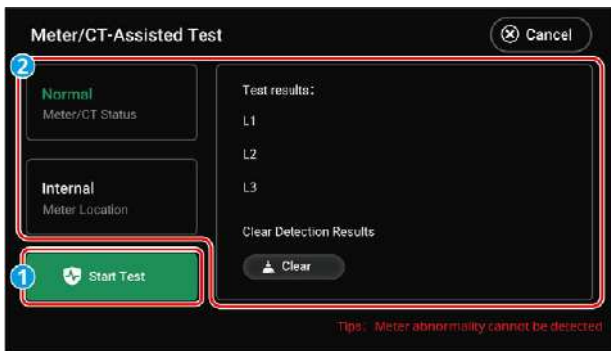

ESU10CON0026

7.1.4 Setting Advanced Parameters

1. From the main interface, click  > Advanced Settings to enter the parameter settings screen. Enter the initial password: 1111.
2. Please set the parameters according to the actual situation.
3. After completing the settings, click Confirm. The parameters are successfully set after the interface prompts Confirm OK.

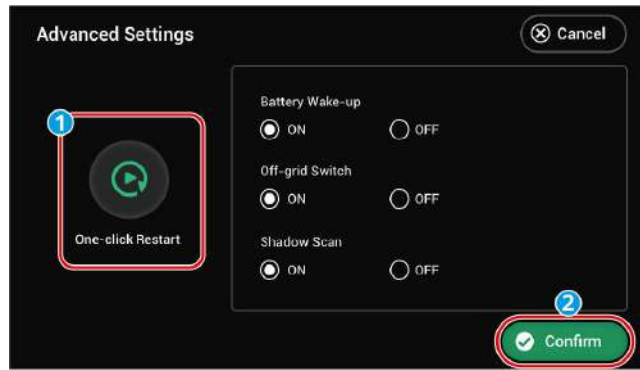

ESU10CON0020

Parameter Name	Description
One-click restart	Using this function, the inverter can be restarted quickly.
Battery Wake-up	When enabled, it can wake up the battery after it shuts down due to under-voltage protection. If there is a circuit breaker between the lithium battery and the inverter, ensure the circuit breaker is closed. After enabling, the output voltage at the battery port is approximately 60V.
Off-grid Switch	In off-grid mode, the off-grid control switch controls the enabling and disabling of the inverter's off-grid function. This function is not effective in grid-tied mode. The switch is initially in the ON state, enabling the off-grid function. After the inverter powers on, it activates the off-grid output function. In the off-grid state, turning the off-grid switch OFF and then ON again can clear the off-grid overload timer and restart the off-grid output.
Shadow Scan	When photovoltaic panels are severely shaded, enabling the shadow scan function can optimize the inverter's power generation efficiency.

7.1.5 Setting Immediate Charging

1. From the main interface, click  > Immediate Charging to enter the parameter setting interface.
2. Please set the parameters according to your actual needs.
3. After completing the settings, click Confirm. When the interface prompts "Confirm OK", the parameter settings are successful.

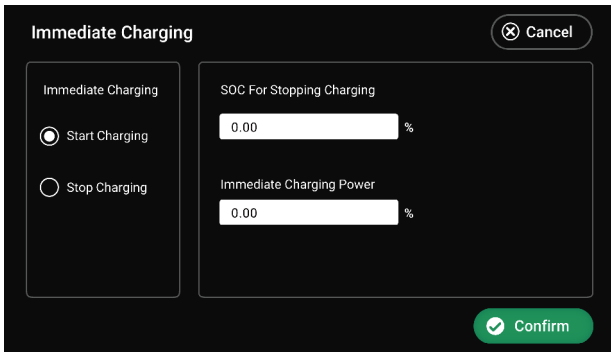

ETL10CON0012

Parameter Name	Description
Immediate Charging	When enabled, the battery is charged immediately from the grid. Takes effect only once. Please enable or stop it based on actual needs.
SOC For Stopping Charging	When Immediate Charging is enabled, battery charging will stop once the battery SOC reaches the charging cutoff SOC.
Immediate Charging Power	When Immediate Charging is enabled, this is the percentage of the inverter's rated power used for charging. For example, for an inverter with a rated power of 10kW, setting this to 60 results in a charging power of 6kW.

7.1.6 Setting the Basic Information

1. From the main interface, click  > Basic Settings to enter the parameter settings interface.
2. Please set the parameters according to the actual situation.
3. After completing the settings, click Confirm. The parameter setting is successful when the interface prompts "Confirm OK".

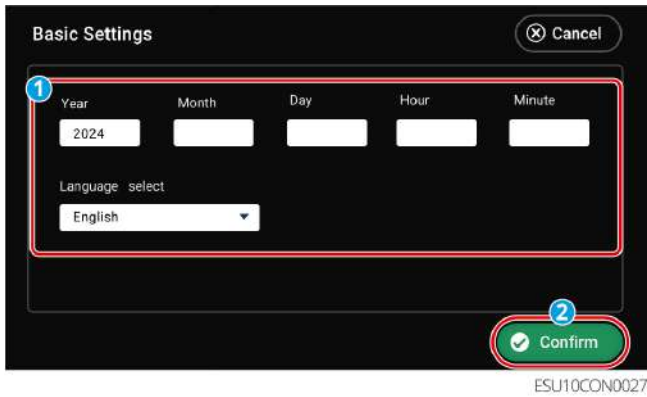

7.1.7 Setting Port Connection

NOTICE

To set parameters for the grid-tied inverter while in microgrid mode, please connect to the APP for configuration.

Setting Port Connection for Generator

1. From the main interface, click  > Port Connection to enter the parameter setting interface.
2. Set the parameters according to the actual situation.
3. After completing the settings, click Confirm. The parameter setting is successful when the interface prompts Confirm OK.

NOTICE

Please ensure to click Confirm on each page to make the parameters take effect, otherwise the system will run with default parameters.

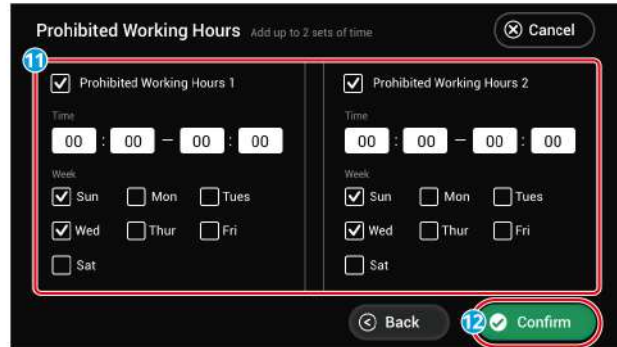
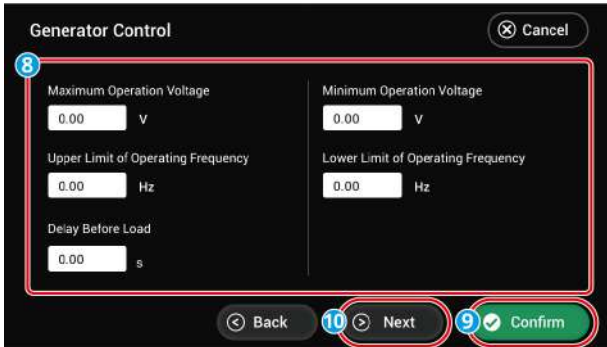
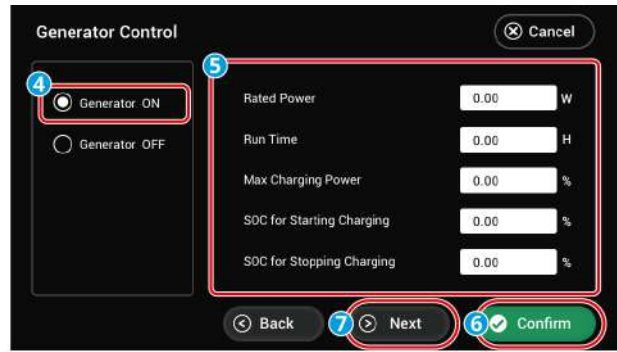
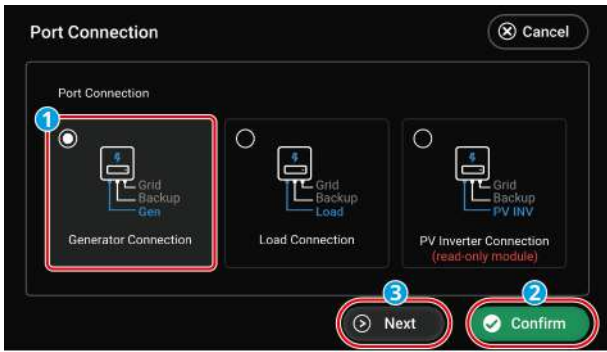

ETL10CON0004

No.	Parameter Name	Description
1	Generator ON/OFF	Controls the start/stop of the generator. Only applicable to generators supporting dry contacts.
2	Rated Power	The rated power of the generator.
3	Run Time	The continuous operation time of the generator. The generator will automatically shut down after exceeding the set runtime. This function is only effective for generators supporting dry contact connections.
4	Max Charging Power	Sets the maximum charging power for the generator to charge the battery.
5	SOC for Starting Charging	Sets the start SOC for the generator to charge the battery. When the battery's SOC falls below the set value, the generator will charge the battery.
6	SOC for Stopping Charging	Sets the SOC for the generator to stop charging the battery. When the battery's SOC reaches the set value, the generator will stop charging the battery.
7	Maximum Operation Voltage	Sets the upper limit of the generator's operating voltage.

8	Minimum Operation Voltage	Sets the lower limit of the generator's operating voltage.
9	Upper Limit Of Operating Frequency	Sets the upper limit of the generator's operating frequency.
10	Lower Limit Of Operating Frequency	Sets the lower limit of the generator's operating frequency.
11	Delay Before Load	The no-load warm-up time for the generator before connecting the load.
12	Prohibited Working Hours	Please set the generator's prohibited working hours according to the actual situation.

Setting Port Connection for Load Control

1. From the main interface, click  > Port Connection to enter the parameter setting interface.
2. Set the parameters according to the actual situation.
3. After completing the settings, click Confirm. The parameter setting is successful when the interface prompts Confirm OK.

NOTICE

Please ensure to click Confirm on each page to make the parameters take effect; otherwise, the system will run with default parameters.

Dry Contact Mode

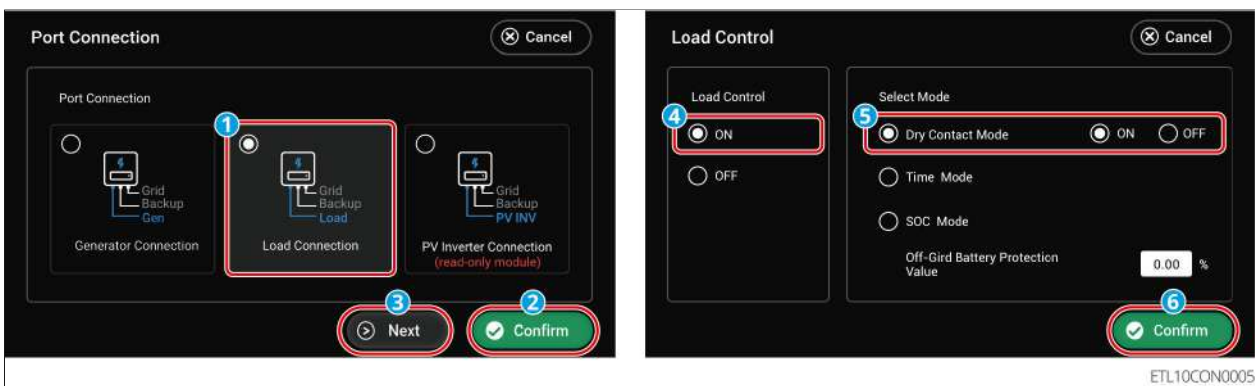

Time Mode

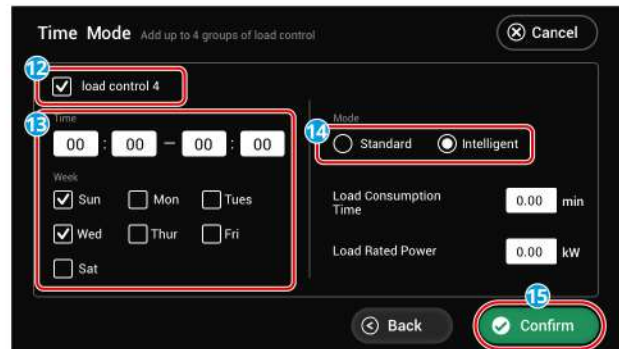
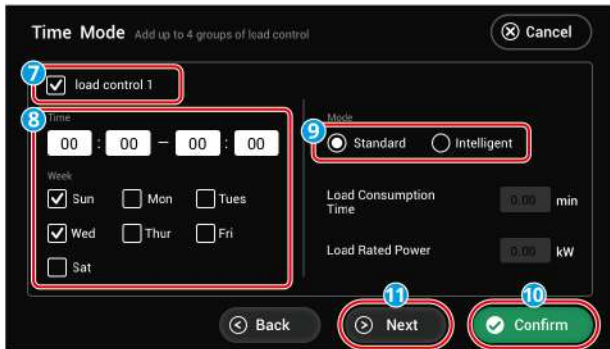
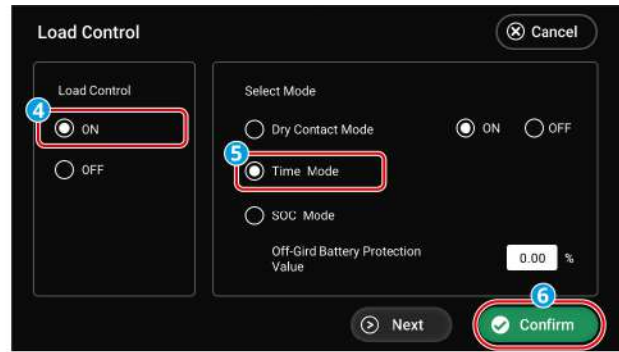
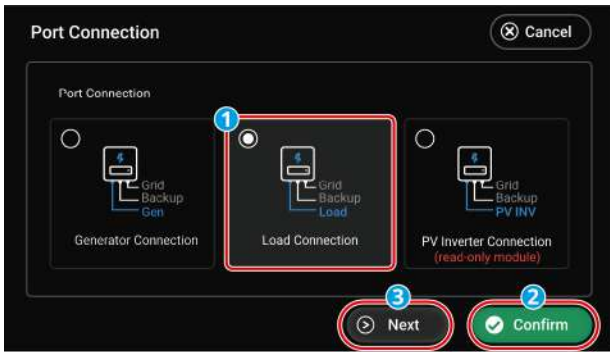

ETL10CON0007

SOC Mode

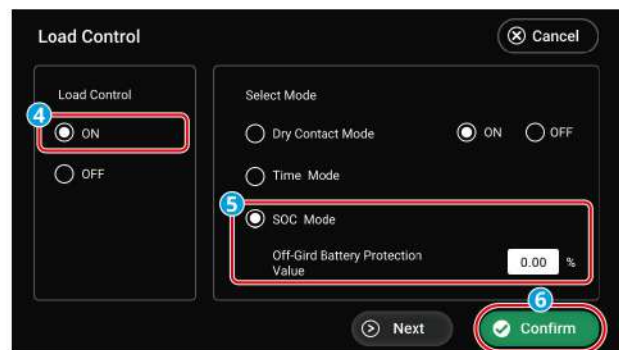
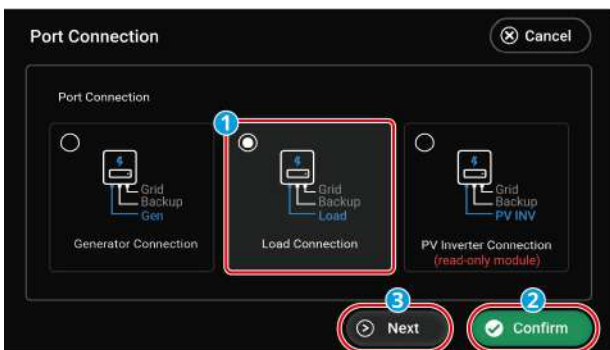

ETL10CON0006

No.	Parameter Name	Description
1	Load Control ON/OFF	Set the load control function ON/OFF
2	Dry Contact Mode	ON: When the switch status is selected as ON, start supplying power to the load. OFF: When the switch status is set to OFF, stop supplying power to the load.
3	Time Mode	Within the set time period, the load will automatically supply power to the load or cut off power. You can choose Standard Mode or Smart Mode.

4	Load Control 1	Set the first group of load control time. A total of 4 groups can be set.
5	Mode: Standard/Intelligent	Standard Mode: Will supply power to the load within the set time period. Smart Mode: Within the set time period, when the surplus energy generated by photovoltaics exceeds the preset load rated power, start supplying power to the load.
6	Load Consumption Time	The minimum running time after the load is turned on, to avoid frequent switching of the load due to energy fluctuations. Only applicable to Smart Mode.
7	Load Rated Power	When the surplus energy generated by photovoltaics exceeds this load rated power, start supplying power to the load. Only applicable to Smart Mode.
8	SOC Mode	The inverter has a built-in relay dry contact control port, which can control whether to supply power to the load through the relay.
9	Off-Grid Battery Protection Value	In off-grid mode, if it detects that the BACK-UP end is overloaded or the battery SOC value is lower than the off-grid battery protection set value, it can stop supplying power to the load connected to the relay port. Please set the off-grid battery protection value according to actual needs.

7.1.8 Viewing Device Information

1. From the main interface, click  > Device Information to enter the parameter query interface.

NOTICE

You can query the inverter serial number, DSP version, BMS version, LCD version, and ARM version.

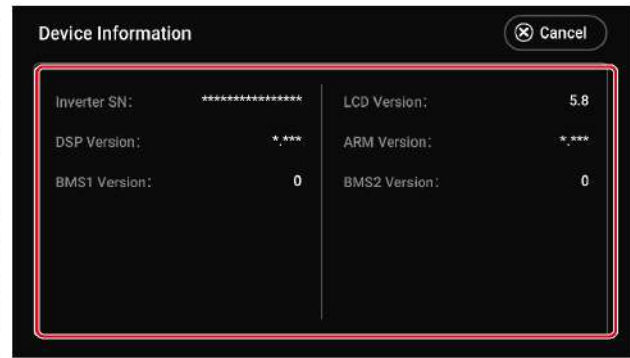

ETL10CON0011

7.2 SolarGo APP

7.2.1 Product Introduction

NOTICE

- All the user interface (UI) screenshots or words in this document are based on **SolarGo app V6.6.0**. The UI may be different due to the version upgrade. The screenshots, words or data are for reference only.
- The method to set parameters is the same for all inverters. But the parameters displayed varies based on the equipment model and safety code. Refer to the actual interface display for specific parameters.
- Before setting any parameters, read through user manual of the App and the inverter or charger to learn the product functions and features. When the inverter parameters are set improperly, the inverter may fail to connect to the utility grid or fail to connect to the utility grid in compliance with related requirements and damage the battery, which will affect the inverter's power generation.

SolarGo App is a mobile application that communicates with the inverter via Bluetooth, WiFi, 4G, or GPRS. Commonly used functions are as follows:

- Check the operating data, software version, alarms of the inverter, etc.
- Set grid parameters and communication parameters of the inverter.
- Set charging mode of the charger.
- Maintain the equipment.

7.2.1.1 Downloading and Installing the App

Make sure that the mobile phone meets the following requirements:

- Mobile phone operating system: Android 5.0 or later, iOS 13.0 or later.
- The mobile phone can access the Internet.
- The mobile phone supports WLAN or Bluetooth.

NOTICE

After installing the app, it can automatically prompt users to update the app version.

Method 1: Search SolarGo in Google Play (Android) or App Store (iOS) to download and install the app.

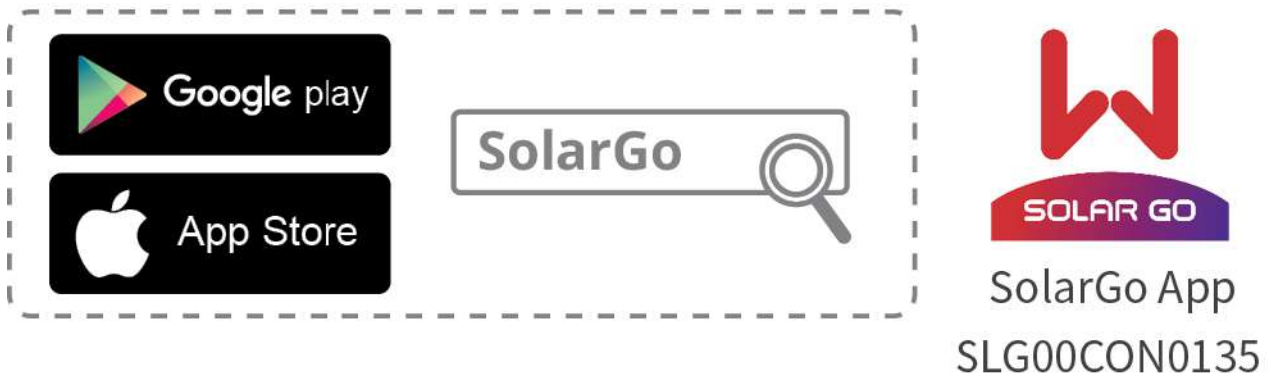

Method 2: Scan the QR code below to download and install the app.

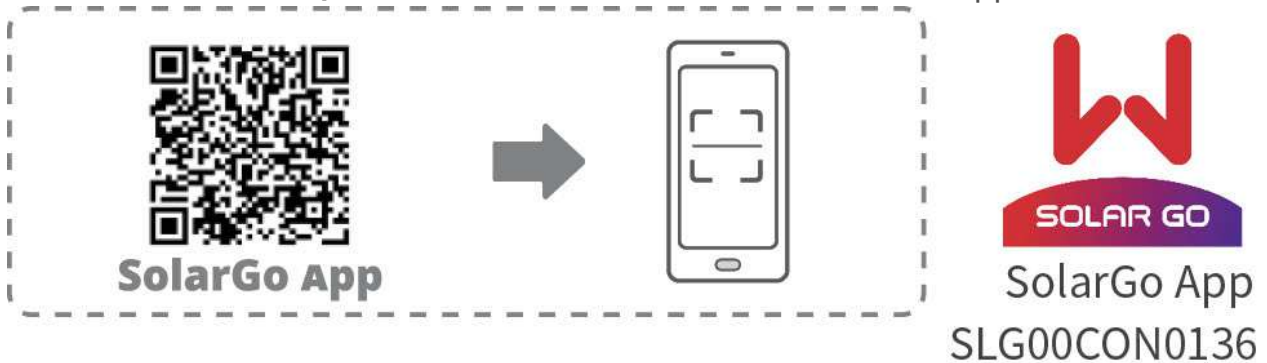

7.2.1.2 App Connection

Connect as the following shows after powering on the equipment.

NOTICE



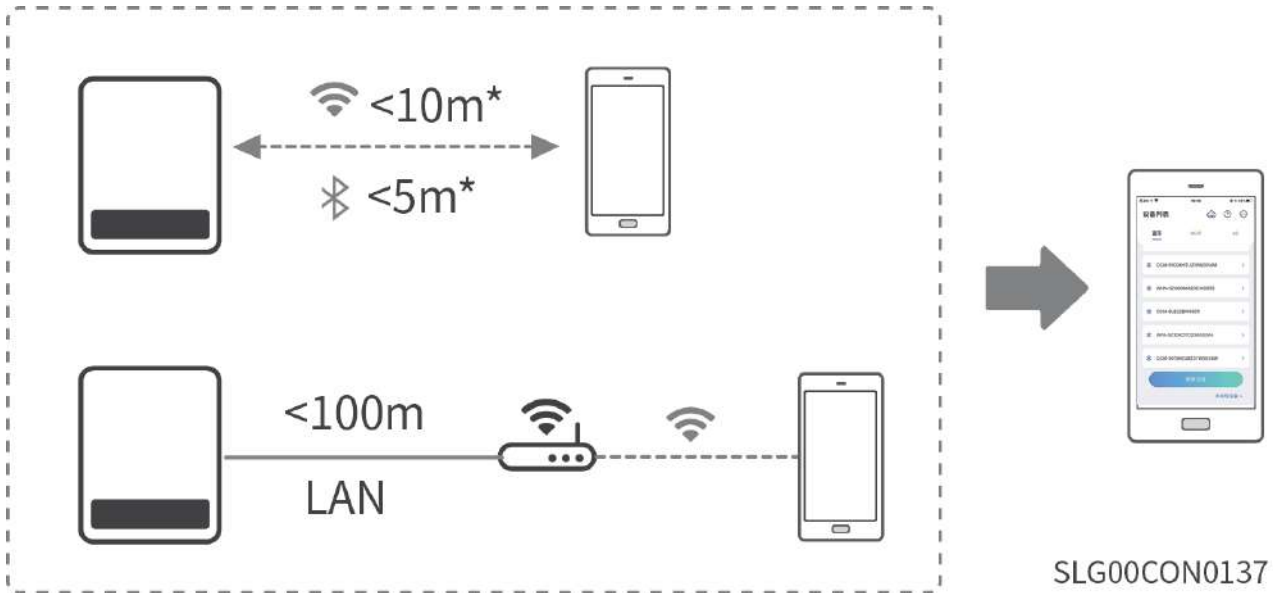

The connection distance varies depending on smart dongles. Refer to the actual used smart dongles.

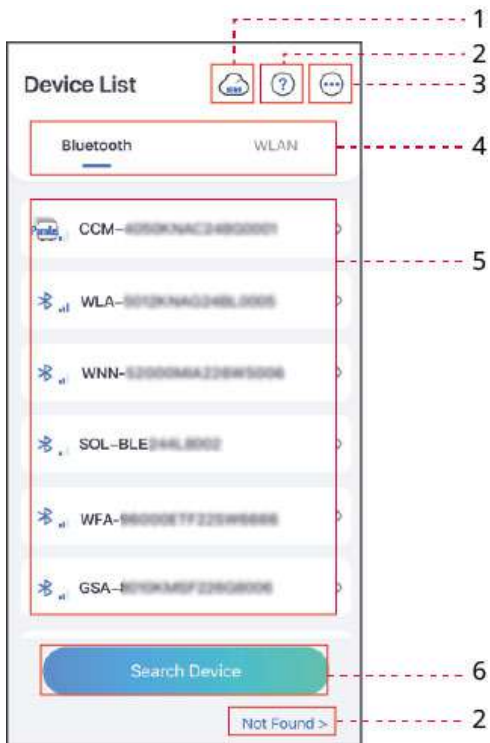

7.2.1.3 GUI Introductions to Login Page



SLG00CON0016

No.	Name/Icon	Description
1		Tap the icon to open the page downloading the SEMS Portal app.
2		Tap to read the connection guide.
	Not found	
3		<ul style="list-style-type: none"> • Check information such as app version, local contacts, etc. • Other settings, such as update date, switch language, set temperature unit, etc.
4	Bluetooth/Wi-Fi/4G	Select based on actual communication method. If you have any problems, tap  or NOT Found to read the connection guides.
5	Device List	<ul style="list-style-type: none"> • The list of all devices. The last digits of the device name are normally the serial number of the device. • Select the device by checking the serial number of the master inverter when multi inverters are parallel connected. • The device name varies depending on the inverter model or smart dongle model: <ul style="list-style-type: none"> ◦ Wi-Fi/LAN Kit, Wi-Fi Kit, Wi-Fi Box: Solar-WiFi*** ◦ External or integrated bluetooth module: Solar-BLE*** ◦ WiFi/LAN Kit-20: WLA-*** ◦ WiFi Kit-20: WFA-*** ◦ Ezlink3000: CCM-BLE***; CCM-***; *** ◦ 4G Kit-CN-G20/4G Kit-CN-G21: GSA-***; GSB-*** ◦ 4G Kit-G20: GSC-*** ◦ Micro inverter: WNN*** ◦ AC Charger: ***
6	Search Device	Tap Search Device if the device is not found.

7.2.2 Connecting the Hybrid Inverter (Bluetooth)

Step 1 Ensure that the inverter is power on, both the inverter and the communication module are working properly.

Step 2 Select **Bluetooth** tab on the SolarGo app homepage.

Step 3 Pull down or tap **Search Device** to refresh the device list. Find the device by the the inverter serial number. Tap the device name to log into the **Home** page. Select the device by checking the serial number of the master inverter when multi inverters are parallel connected.

Step 4 For first connection with the equipment via Bluetooth, there will be a Bluetooth pairing prompt, tap **Pair** to continue the connection.

Step 5 Log in as an Owner or an Installer. Initial password: 1234. Default password: 1234.

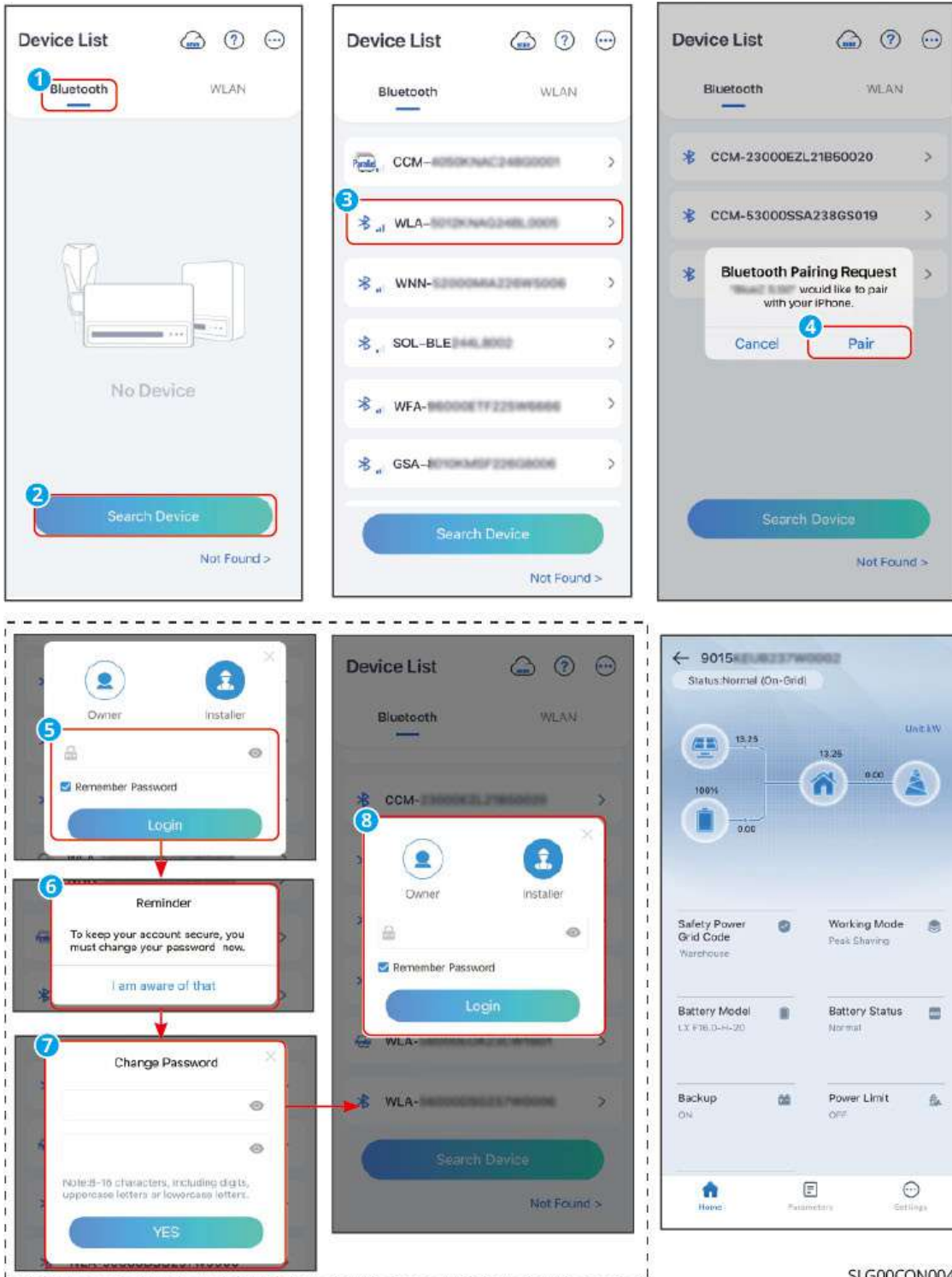

Step 6 (Optional): If connecting via WLA-*** or WFA-***, enable Bluetooth Stays On following the prompts as entering the device details page. Otherwise, the bluetooth signal of the device will be off after disconnection.



SLG00CON0045

7.2.3 GUI Introductions to Hybrid Inverters



No.	Name/Icon	Description
1	Serial Number	Serial number of the connected inverter.
2	Device Status	Indicates the status of the inverter, such as Working,Fault, etc.
3	Energy Flow Chart	Indicates the energy flow chart of the PV system. The actual page prevails.
4	System Status	Indicates the system status, such as Safety Code, Working Mode, Battery Model, Battery Status, Power Limit, Three-Phase Unbalanced Output, etc..
5		Home. Tap Home to checkSerial Number, Device Status, Energy Flow Chart, System Status, etc.
6		Parameters. Tap Parameters to check the inverter Data.

No.	Name/Icon	Description
7		<ul style="list-style-type: none"> • Settings Tap to perform quick settings, basic settings, advanced settings, etc. on the inverter. • Login required to access Quick Setup and Advanced Setting. Contact the supplier or after sales service for password. Password for professional technicians only.

7.2.4 Setting Communication Parameters

NOTICE

The communication configuration interface may be different if the inverter uses different communication modes or connects different communication modules. Please refer to the actual interface.

7.2.4.1 Setting Privacy and Security Parameters

Type I

Step 1 : Tap **Home** > **Settings** > **Communication Setting** > **Privacy & Security** to set the parameters.

Step 2 : Set the new password for the WiFi hotspot of the communication module, and tap **Save**.

Step 3 Open the WiFi settings of your phone and connect to the inverter's WiFi signal (Solar WiFi***) with the new password.

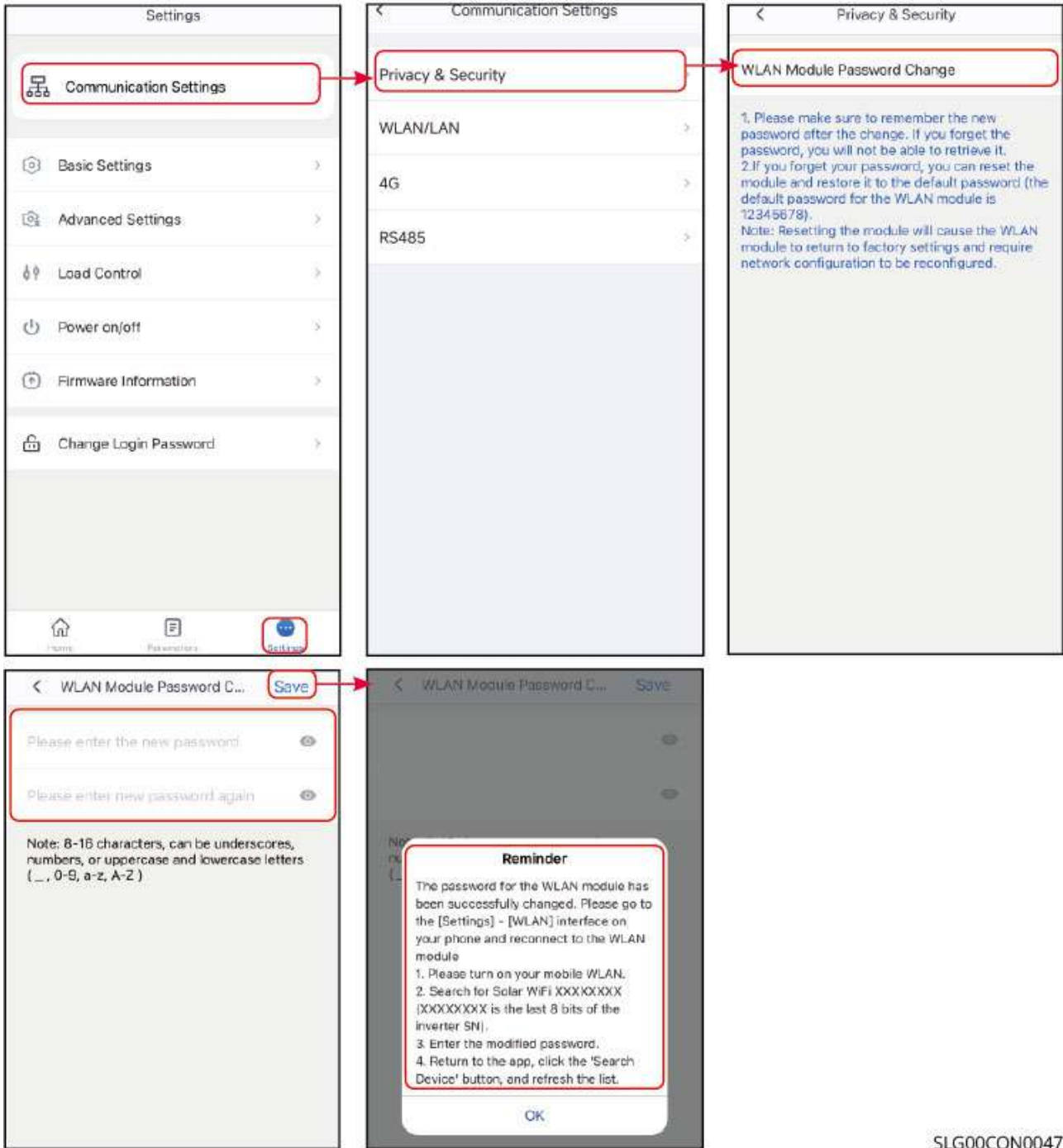

SLG00CON0047

Type II

Step 1 : Tap **Home > Settings > Communication Setting > Privacy & Security** to set the parameters.

Step 2 Enable Bluetooth Stays On or WLAN Control based on actual needs.

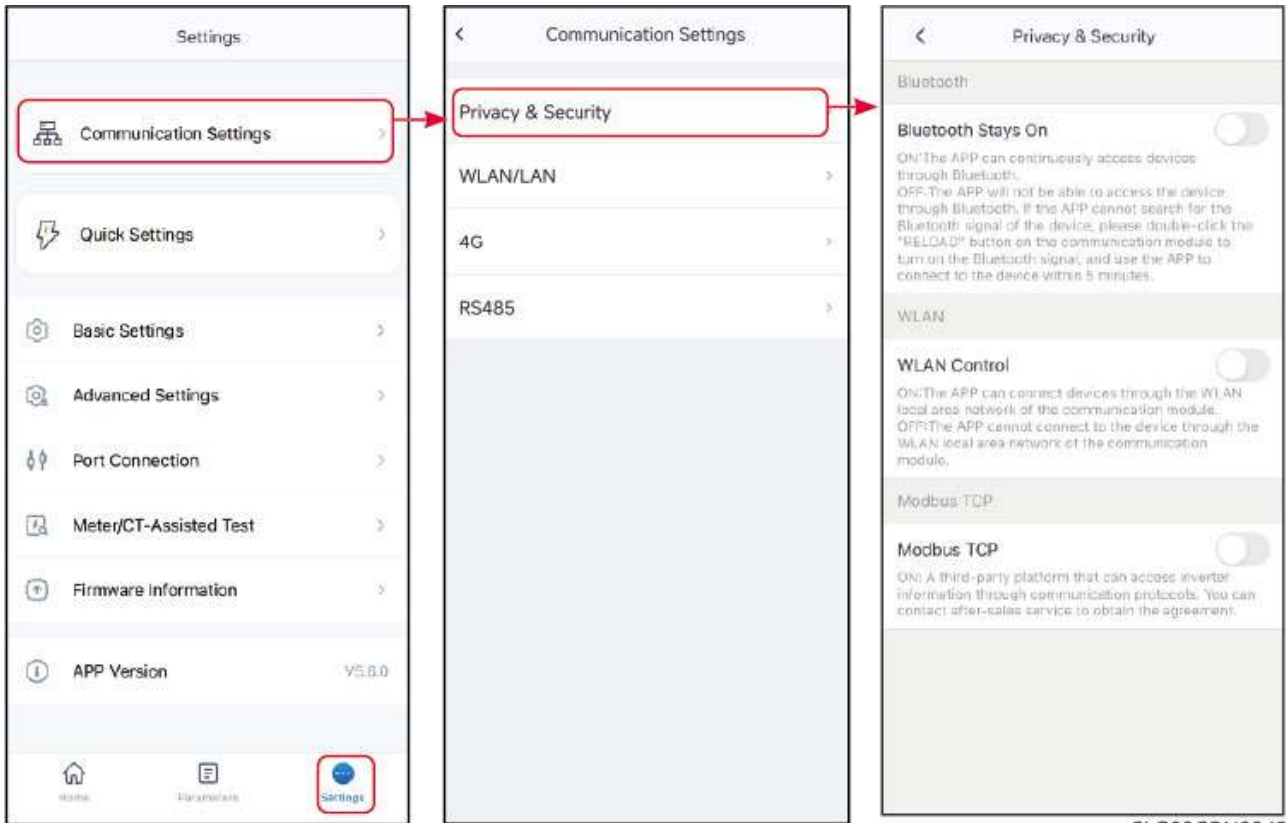

SLG00CON0048

No.	Parameters	Description
1	Bluetooth Stays On	Disabled by default. Enable the function, the bluetooth of the device will be contentious on to keep connected to SolarGo. Otherwise, the bluetooth will be off in 5 minutes, and the device will be disconnected from SolarGo.
2	WLAN Control	Disabled by default. Enable the function, the device and the SolarGo can be connected through the WLAN when they are on the same LAN. Otherwise, they cannot be connected even if they are on the same LAN.
3	Modbus-TCP	Enable the function, the third party monitoring platform can access inverter through Modbus-TCP communication protocol.
4	SSH control Ezlink	After enabling this function, third-party platforms can connect to and control EzLink's Linux system.

Type III

Step 1 : Tap **Home > Settings > Communication Setting > Privacy & Security** to set

the parameters.

Step 2 : Enable **Bluetooth Stays On** or **Login Password** based on actual needs.

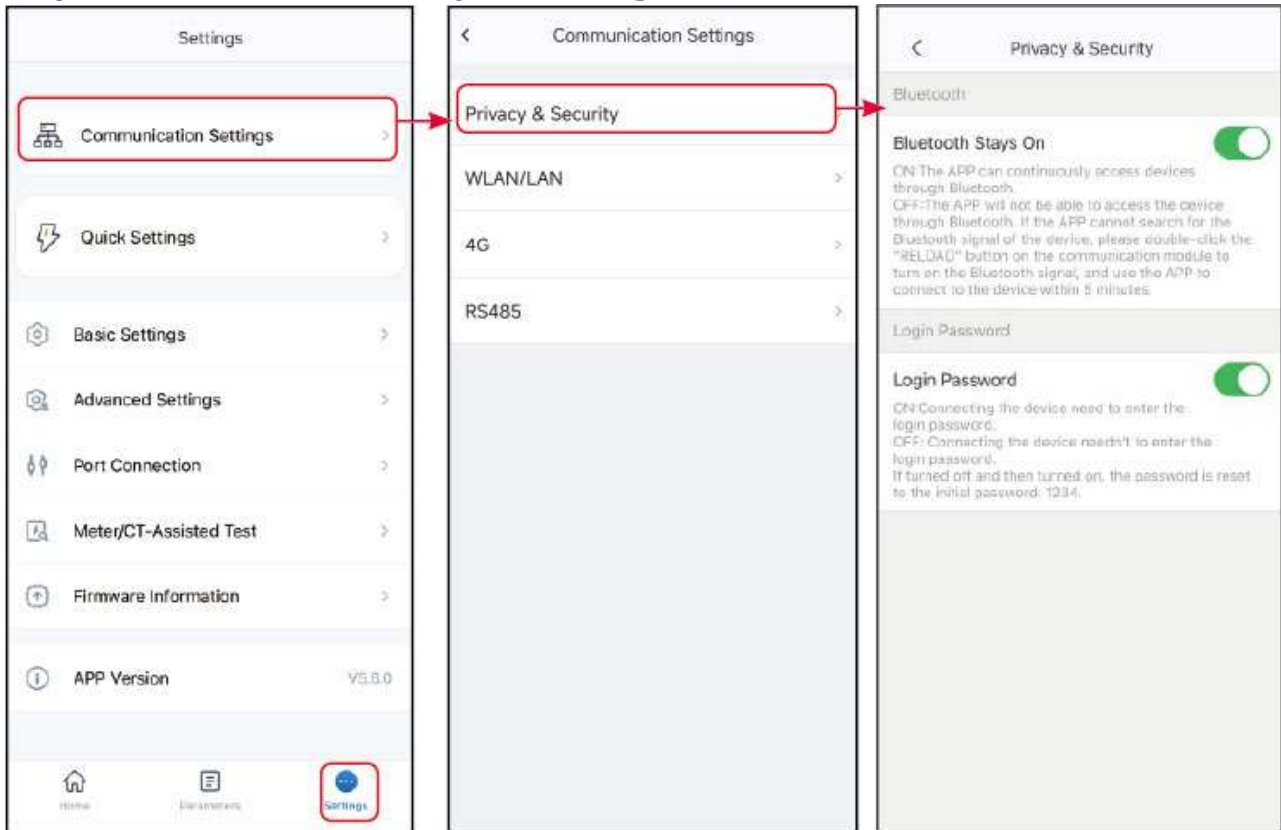

SLG00CON0049

No.	Parameters	Description
1	Bluetooth Stays On	Disabled by default. Enable the function, the bluetooth of the device will be contentious on to keep connected to SolarGo. Otherwise, the bluetooth will be off in 5 minutes, and the device will be disconnected from SolarGo.
2	Password	Disabled by default. Enable the function, you will be prompted to enter the login password when connecting the device to SolarGo. Use the initial password and change it at the first login prompt.

7.2.4.2 Setting WLAN/LAN Parameters

NOTICE

When the inverter is connected to different communication modules, the communication configuration interface may be different. Please refer to the actual interface.

Step 1 : Tap **Home > Settings > Communication Setting > WLAN/LAN** to set the parameters.

Step 2 : Configure the WLAN or LAN parameters based on actual needs.

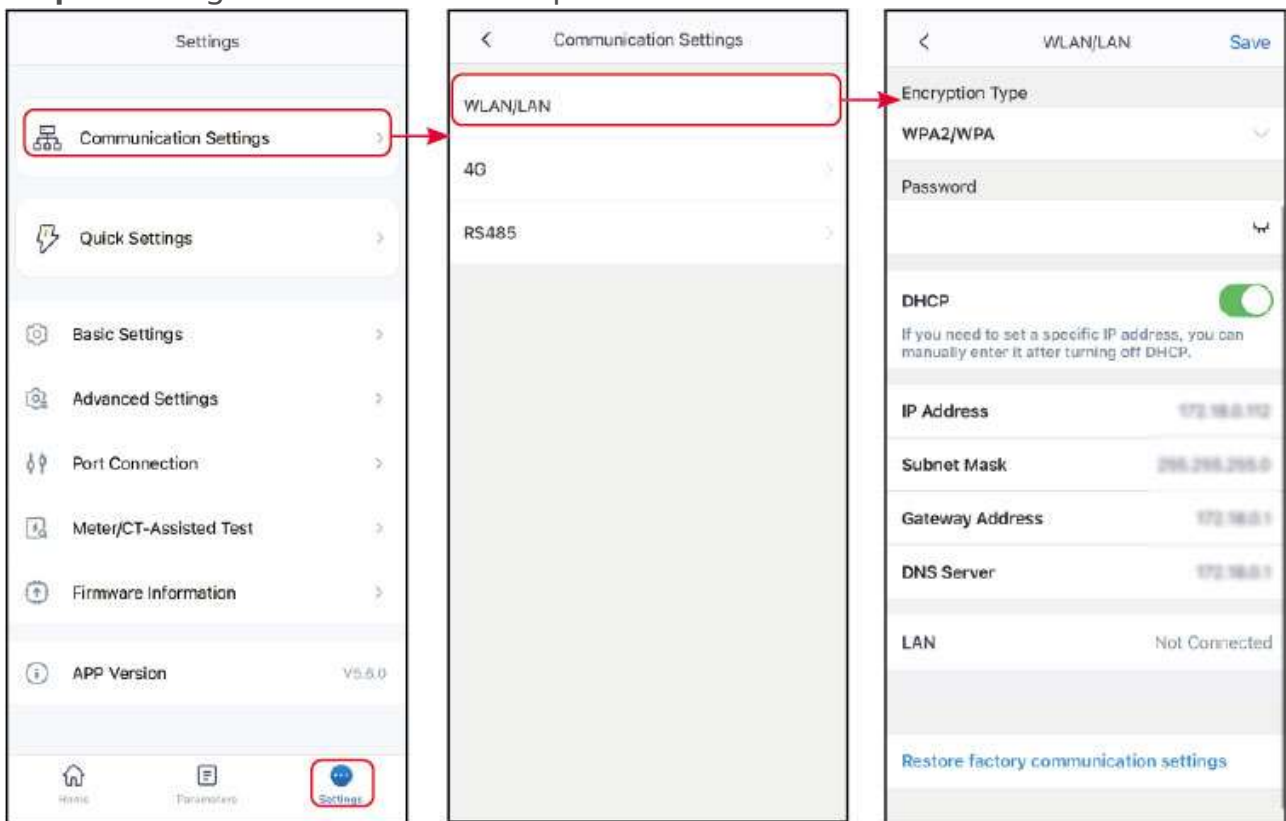

SLG00CON0050

No.	Parameters	Description
1	Network Name	Only for WLAN. Select WiFi based on the actual connecting.
2	Password	Only for WLAN. WiFi password for the actual connected network.
3	DHCP	Enable DHCP when the router is in dynamic IP mode. Disable DHCP when a switch is used or the router is in static IP mode.

No.	Parameters	Description
4	IP Address	Do not configure the parameters when DHCP is enabled. Configure the parameters according to the router or switch information when DHCP is disabled.
5	Subnet Mask	
6	Gateway Address	
7	DNS Server	

7.2.4.3 Configuring RS485 Parameters

NOTICE

Set the communication address of the inverter. For a single inverter, the address is set based on actual needs. For multi connected inverters, the address of each inverter should be different while cannot be 247.

Step 1: Tap **Home > Settings > Communication Settings > RS485** to set the parameters.

Step 2 : Set the Modbus Address And Baud Rate base on actual situation.

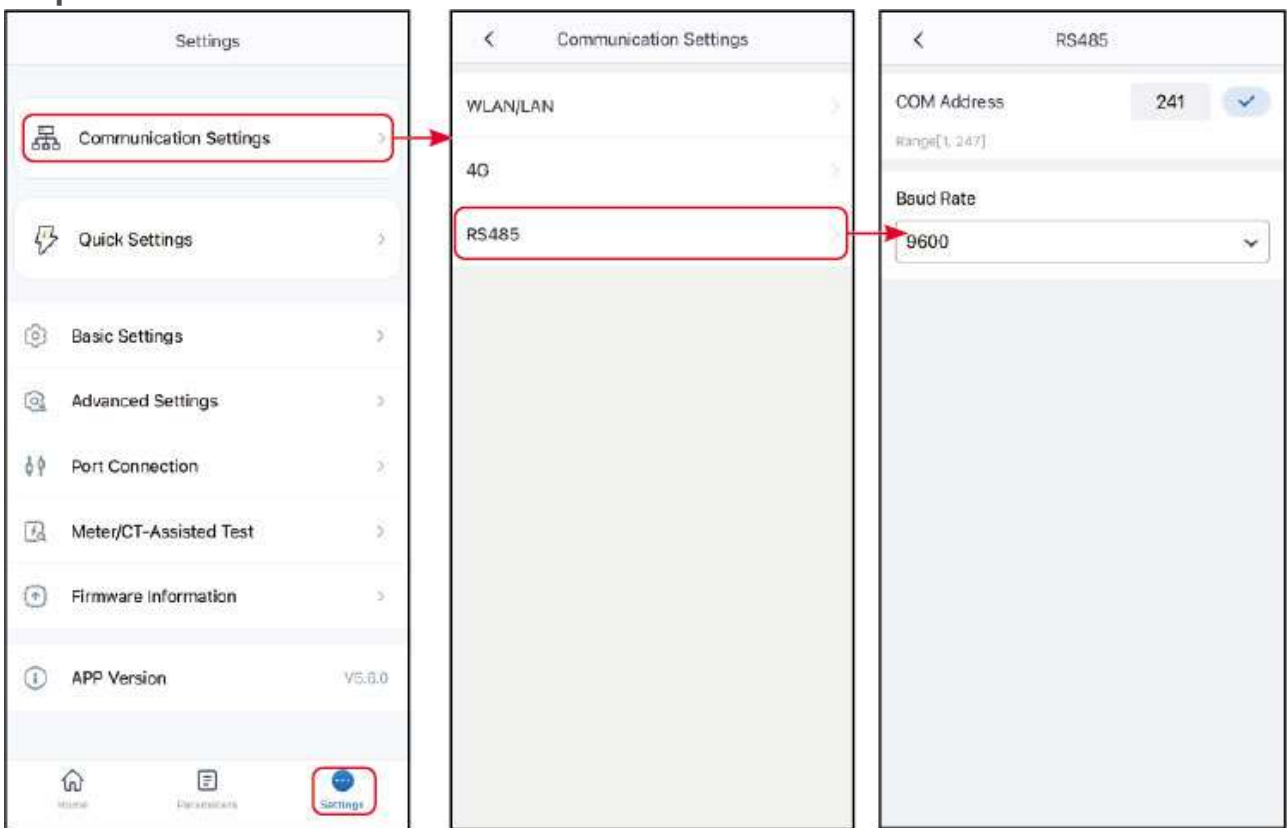

SLG00CON0052

7.2.4.4 WLAN Detection

Step 1 : Tap **Home > Settings > Communication Settings > WLAN Detection..**

Step 2 : Tap **Diagnosis** to check the network connection status.

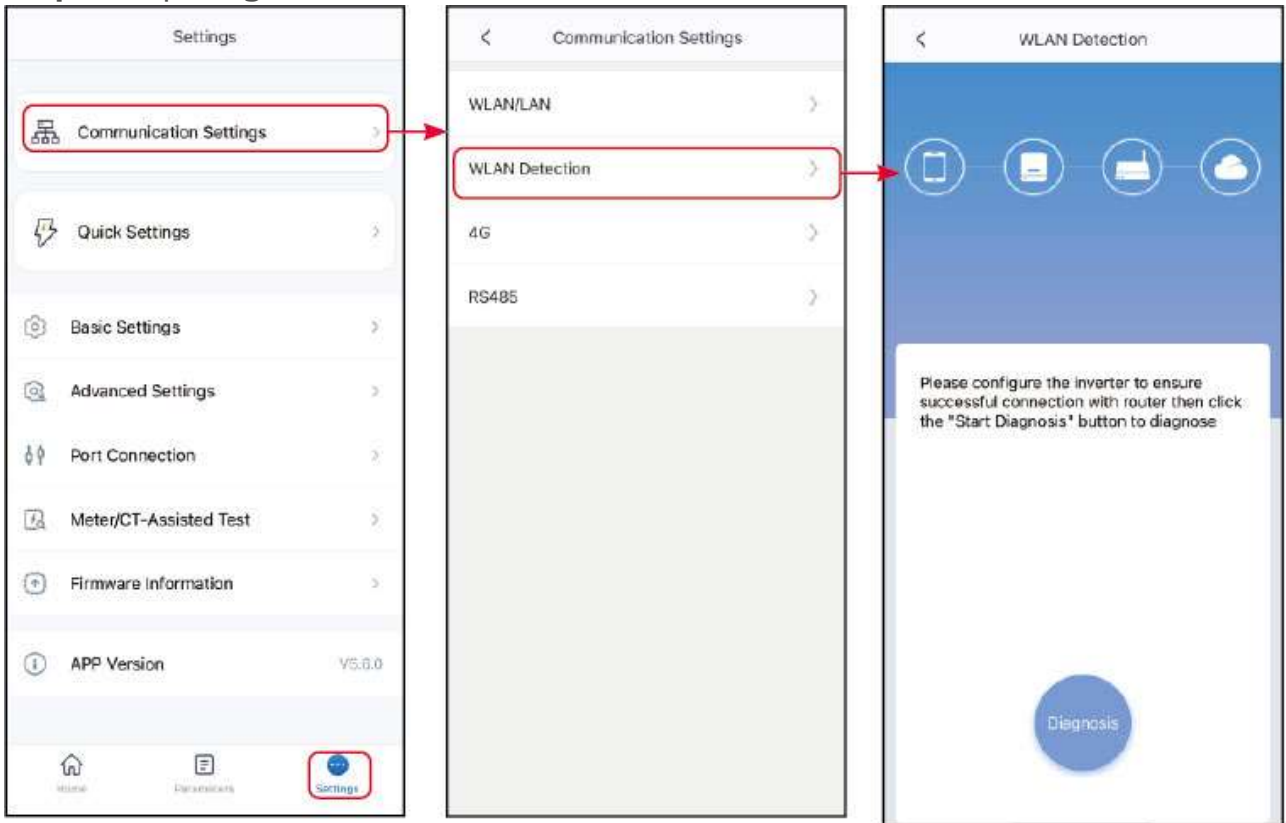

SLG00CON0053

7.2.5 Setting Up the RS485 Parallel System

NOTICE

- When paralleling hybrid inverters via RS485, you must set each inverter as the master or slave inverter individually using the SolarGo App.
- When an inverter in a parallel system needs to be used as a single unit, it must be set to standalone inverter via the SolarGo App.
- Please set the inverter connected to the meter as the master.
- Please first set the slave inverter address, then set the parallel network through the master.

Step 1: Go to the settings interface via **Settings > Parallel System Settings .**

Step 2: Set the inverter to Master, Slave, or Stand-alone based on its actual wiring.

- If the inverter is the master, set it to Master and then exit the connection. After setting the slave inverter address, return to this interface, click **Parallel Networking**, set the number of inverters in the parallel system, and then click **Network**.
- If the inverter is the slave, set the **Inverter Address** and click ✓.

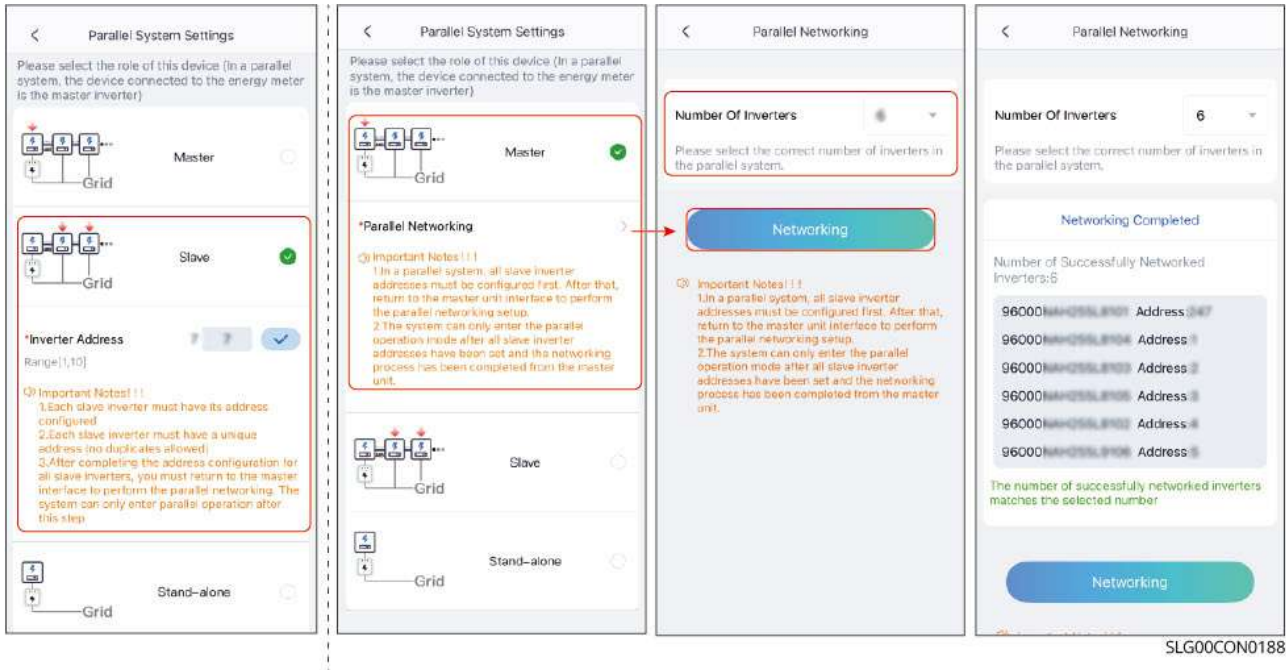

7.2.6 Quick Setting the Basic Information

NOTICE

- The setting page varies depending on inverter model.
- The parameters will be configured automatically after selecting the safety country/region, including overvoltage protection, undervoltage protection, overfrequency protection, underfrequency protection, voltage/frequency connection protection, $\cos\phi$ curve, Q(U) curve, P(U) curve, FP curve, HVRT, LVRT, etc. Tap Home > Settings > Advanced Settings > Safety Parameters to check the parameters after selecting the safety country.
- The power generation efficiency is different in different working modes. Set the working mode according to the local requirements and situation.
 - Self-use mode: The basic working mode of the system. PV power generation is used to supply power to the load first, the excess power is used to charge the battery, and the remaining power is sold to the grid. When PV power generation cannot meet the load's power demand, the battery will supply power to the load; when the battery power also cannot meet the load's power demand, the grid will supply power to the load.
 - Back-up mode: The back-up mode is mainly applied to the scenario where the grid is unstable. When the grid is disconnected, the inverter turns to off-grid mode and the battery will supply power to the load; when the grid is restored, the inverter switches to grid-tied mode.
 - Economic mode: It is recommended to use economic mode in scenarios when the peak-valley electricity price varies a lot. Select Economic mode only when it meets the local laws and regulations. Set the battery to charge mode during Vally period to charge battery with grid power. And set the battery to discharge mode during Peak period to power the load with the battery.
 - Off-grid mode: suitable for areas without power grid. PV and batteries form a pure off-grid system. PV generates electricity to power the load and excess electricity charges the battery. When PV power generation cannot meet the power demand of the load, the battery will supply power to the load.
 - Smart charging: In some countries/regions, the PV power feed into the utility grid is limited. Select Smart Charging to charge the battery using the surplus power to minimize PV power waste.
 - Peak shaving mode: Peak shaving mode is mainly applicable to peak power limited scenarios. When the total power consumption of the load exceeds the power consumption quota in a short period of time, battery discharge can be used to reduce the power exceeding the quota.

7.2.6.1 Quick Setting the Basic Information(Type II)

Step 1: Tap **Home > Settings > Quick Settings** to set the parameters.

Step 2 : Enter the password for quick settings. Contact the supplier or after sales service for password. Password for professional technicians only.

Step 3 : Some models support one-click configuration. Select **Guided Mode** to quickly configure the system.

Step 4: Select safety country accordingly. Tap **Next** to set the Battery Connect Mode.

Step 5 : Select the actual mode in which the battery is connected to the inverter. The basic settings are completed if there is no battery connected in the system. Tap **Next** to set the Battery Model if there is any battery connected in the system.

Step 6: Select the actual battery model. Tap **Next** to set the Working Mode.

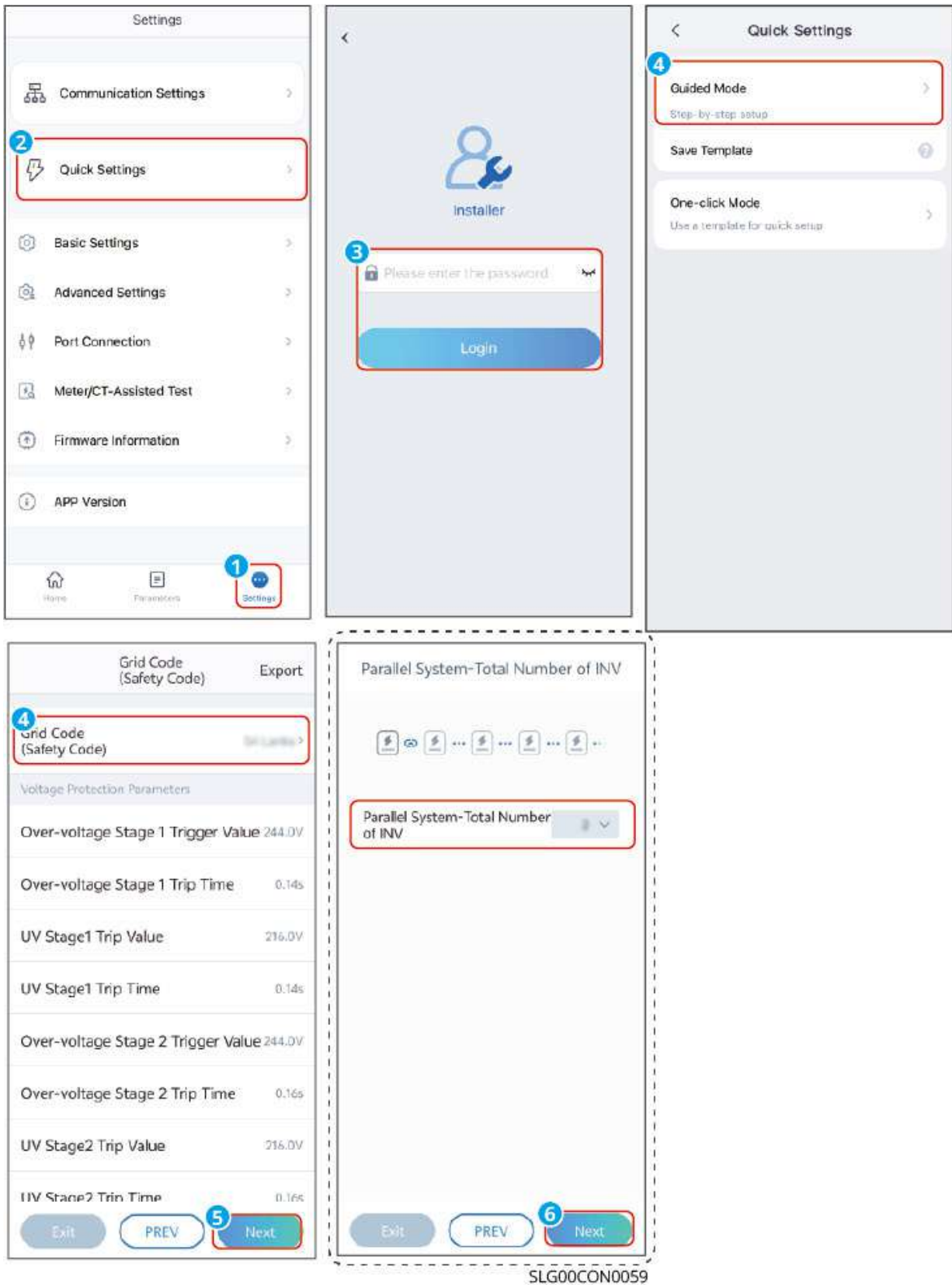

Step 7: Set the working mode based on actual needs. Tap **Next** to set the Working Mode. For some models, after the working mode configuration is completed, it will

automatically enter the CT/meter self-test state. At this time, the inverter will temporarily disconnect from the grid and then automatically reconnect.

Step 8 : Select the battery based on actual situation whether it is **First Installation, Routine Operation** or **Replacement Installation**.

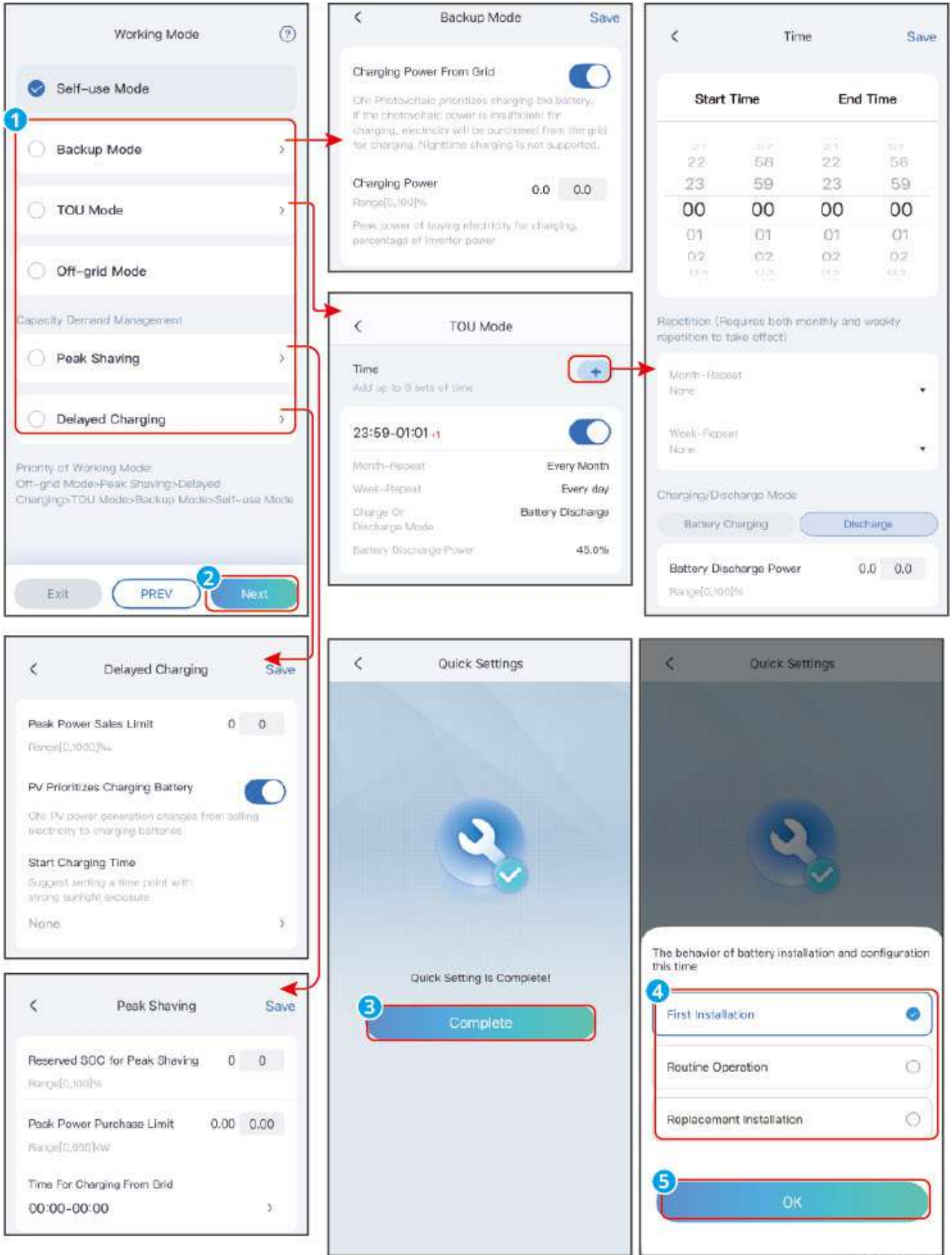

SLG00CON0060

No.	Parameters	Description
Back-up mode		
1	Charging Power From Grid	Enable Charging Power From Grid to allow power purchasing from the utility grid.
2	Charging Power	The percentage of the purchasing power to the rated power of the inverter.
TOU mode		
3	Start Time	Within the Start Time and End Time, the battery is charged or discharged according to the set Battery Mode as well as the Rated Power.
4	End Time	
5	Charge Discharge Mode	Charge or discharge according to actual needs.
6	Rated Power	The percentage of the charging/discharging power to the rated power of the inverter.
7	Charge Cut-off SOC	The battery stop charging/discharging once the battery SOC reaches Charge Cut-off SOC.
Peakshaving		
8	Reserved SOC For Peakshaving	In Peak Shaving mode, the battery SOC should be lower than Reserved SOC For Peakshaving. Once the battery SOC is higher than Reserved SOC For Peakshaving, the peak shaving mode fails.
9	Peak Power Purchase Limit	Set the maximum power limit allowed to purchase from the grid. When the loads consume power exceed the sum of the power generated in the PV system and Peak Power Purchase Limit, the excess power will be made up by the battery.
10	Time for Charging From Grid	The utility grid will charge the battery between Start Time and End Time if the load power consumption do not exceed the power quota. Otherwise, only PV power can be used to charge the battery. Otherwise, only PV power can be used to charge the battery.

No.	Parameters	Description
Smart charging		
11	Peak Power Sales Limit	Set the Peak Power Sales Limit in compliance with local laws and regulations. The Peak Limiting Power shall be lower than the output power limit specified by local requirements.
12	PV Prioritizes Charging Battery	During charging time, the PV power will first charge the battery.
13	Start Charging Time	

7.2.7 Setting the Basic Information

7.2.7.1 Setting the SPD

After enabling SPD, when the SPD module is abnormal, there will be SPD module abnormal alarm prompt.

Step 1 : Tap **Home > Settings > Basic Settings > SPD**, to set the parameters.

Step 2 : enable or disable the function based on actual needs.

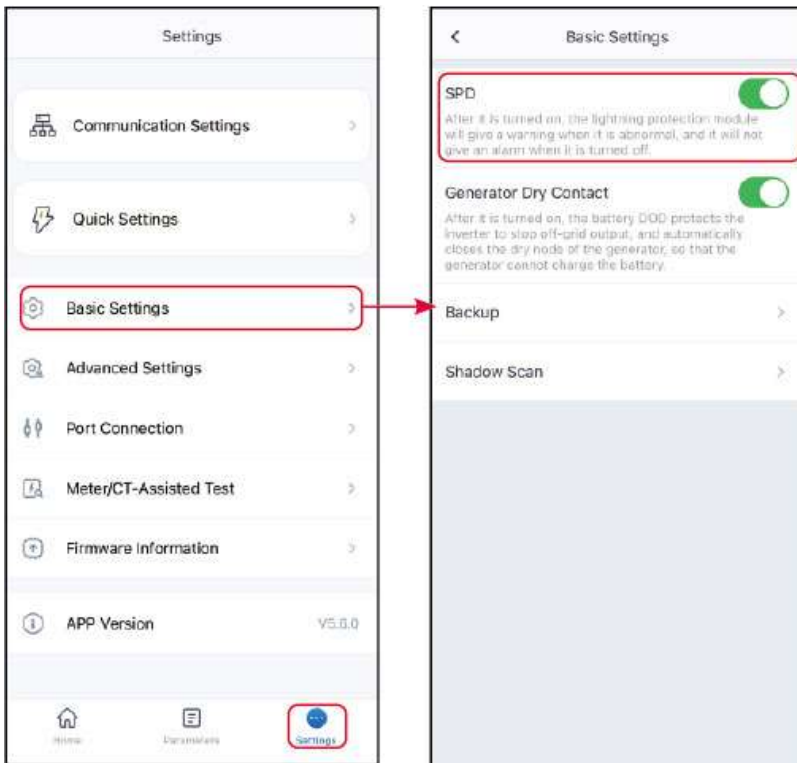

SLG00CON0062

7.2.7.2 Setting the Back-up Power Parameters

After enabling Backup, the battery will power the load connected to the backup port of the inverter to ensure Uninterrupted Power Supply when the power grid fails.

Step 1 : Tap **Home > Settings > Basic Settings > Backup**, to set the parameters.

Step 2 : Set the backup supply function based on actual needs.

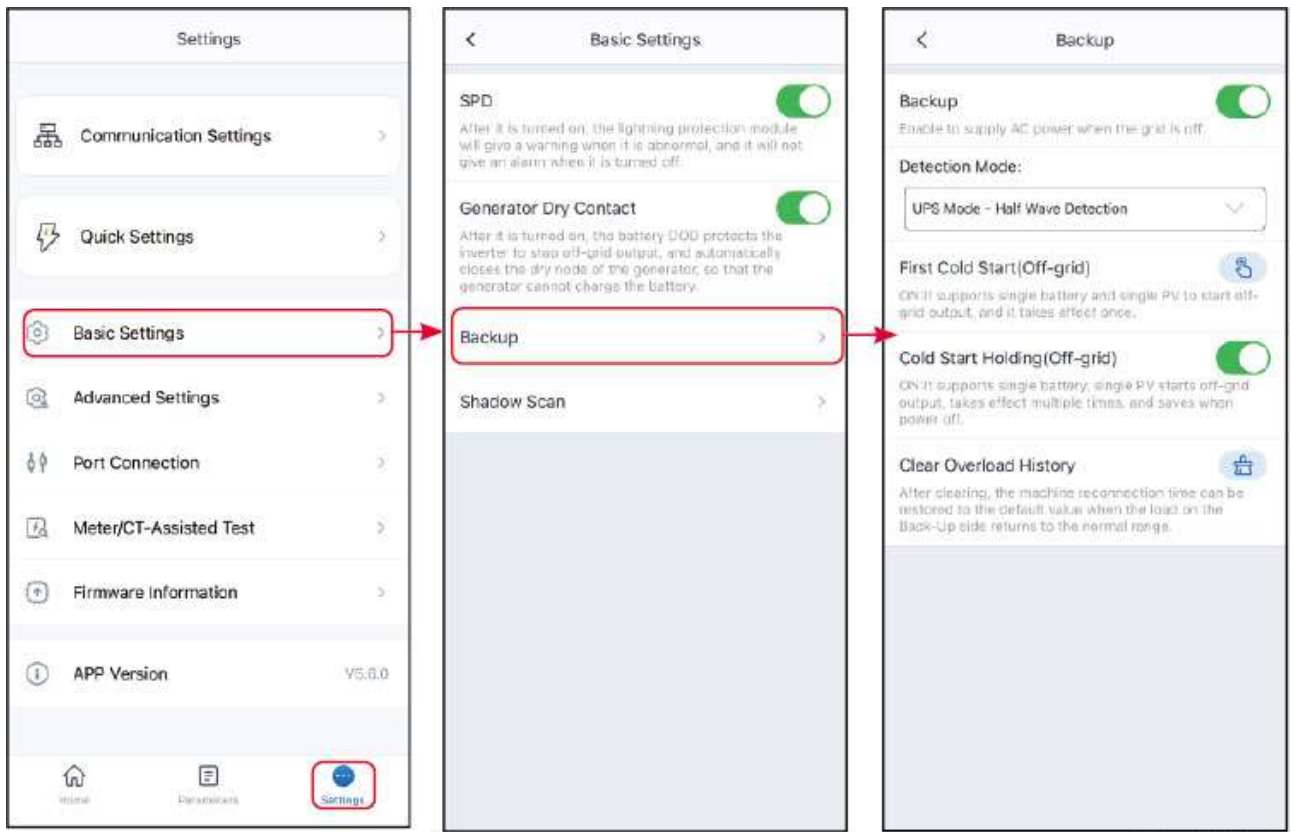

SLG00CON0064

No.	Parameters	Description
1	UPS Mode- Full Wave Detection	Check whether the utility grid voltage is too high or too low.
2	UPS Mode- Half Wave Detection	Check whether the utility grid voltage is too low.
3	EPSmode-with LVRT support.	Stop detecting utility grid voltage.
4	First Cold Start (Off-grid)	It will only take effect once. In off-grid mode, enable First Cold Start (Off-grid) to output backup supply with battery or PV.
5	Cold Start Holding (Off-grid)	Take effect multiple times. In off-grid mode, enable First Cold Start (Off-grid) to output backup supply with battery or PV.

No.	Parameters	Description
6	Clear Overload History	Once the power of loads connected to the inverter BACK-UP ports exceeds the rated load power, the inverter will restart and detect the power again. The inverter will perform restart and detection several times until the overloading problem is solved. Tap Clear Overload History to reset the restart time interval after the power of the loads connected to the BACK-UP ports meets the requirements. The inverter will restart immediately.

7.2.7.3 Setting the Shadow Scan

Enable Shadow Scan when the PV panels are severely shadowed to optimize the power generation efficiency.

Step 1 : Tap **Home > Settings > Basic Settings> Shadow Scan**, to set the parameters.

Step 2: Enable or disable the function based on actual needs. Set the Shadow Scan interval and MPPT shadow scan if the inverter supports.

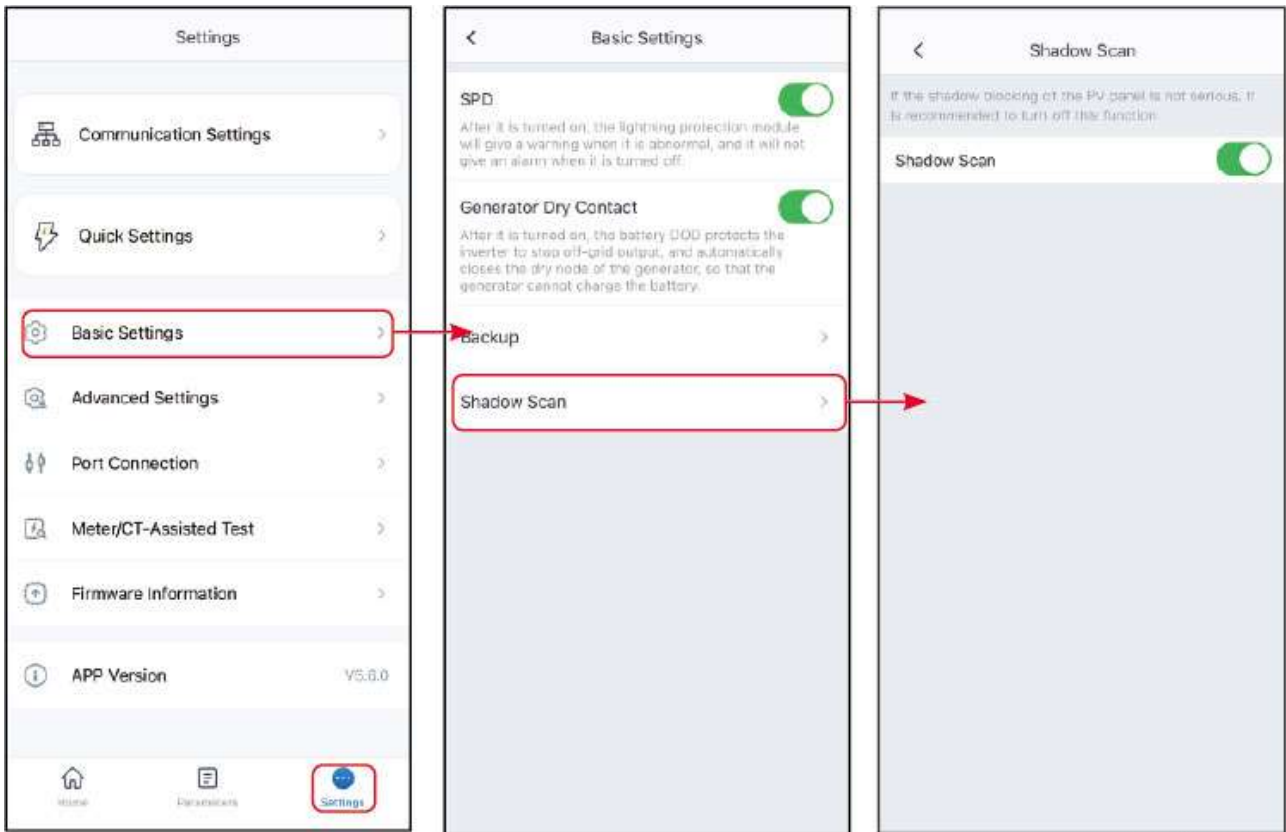

SLG00CON0063

7.2.7.4 Setting Power Adjustment Parameters

Step 1: Go to the settings interface via **Home > Settings > Basic Settings > Power Scheduling**.

Step 2: Set the active power dispatch or reactive power dispatch parameters according to the actual situation.

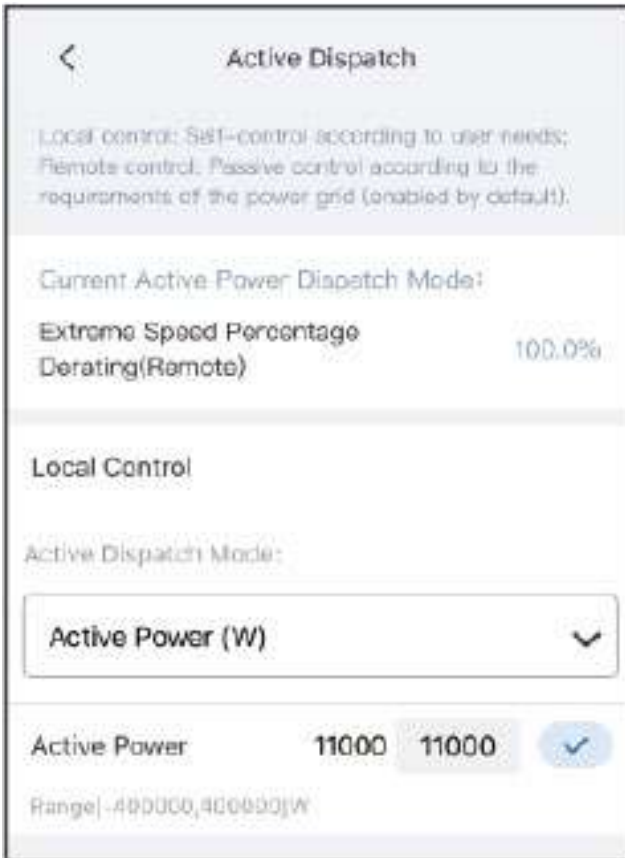

SLG00CON0124

No.	Parameter	Description
	Active Scheduling	

No.	Parameter	Description
1	Active Scheduling Mode	<p>According to the requirements of the power grid company in the country/region where the inverter is located, control the active power according to the selected dispatch mode. Supports:</p> <ul style="list-style-type: none"> • Disabled: Disables active scheduling. • Fixed value reduction: Dispatch according to a fixed value. • Percentage reduction: Dispatch based on a percentage of the rated power.
2	Active Power	<ul style="list-style-type: none"> • When the active power dispatch mode is set to fixed value derating, the active power is set to a fixed value. • When the active power dispatch mode is set to percentage derating, the active power is set as a percentage of the rated power. 比。
Reactive Scheduling		
3	Reactive Scheduling Mode	<p>According to the requirements of the power grid company in the country/region where the inverter is located, control the reactive power according to the selected dispatch mode. Supports:</p> <ul style="list-style-type: none"> • Disabled: Disables reactive scheduling. • Fixed value compensation: Dispatch according to a fixed value. • Percentage compensation: Dispatch based on a percentage of the rated power. • PF compensation.
4	Status	Set the power factor as lagging or leading based on actual needs and local grid standards and requirements.

No.	Parameter	Description
5	Reactive Power	<ul style="list-style-type: none"> When the reactive power dispatch mode is set to fixed value derating, the reactive power is set to a fixed value. When the reactive power dispatch mode is set to percentage derating, the reactive power is set as a percentage of the rated power.
6	Power Factor	When the reactive power dispatch mode is set to PF compensation, set the power factor.

7.2.8 Setting Advanced Parameters

NOTICE

Contact the supplier or after sales service for Advanced Setting password.
Password for professional technicians only.

7.2.8.1 Setting Three-phase Unbalanced Output

Enable the Three-phase unbalanced output when connecting unbalanced loads, which means L1, L2, L3 of the inverter respectively connected to loads with different power. Only for three phase inverters.

Step 1 : Tap **Home > Settings > Advanced Settings > Three-phase Unbalanced Output** to set the parameters.

Step 2 : Enable or disable the function based on actual needs.

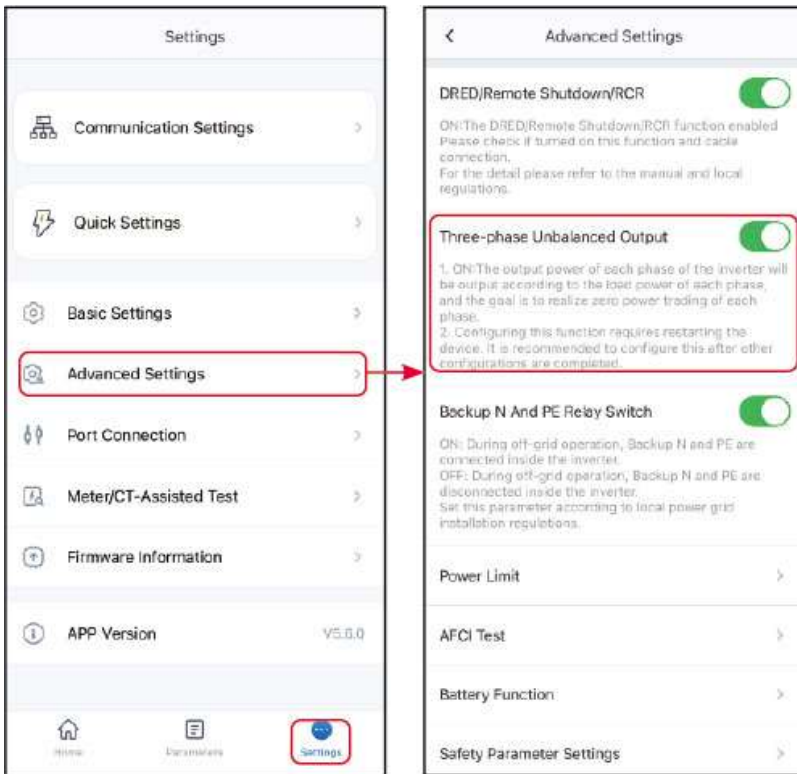

SLG00CON0068

7.2.8.2 Setting the Backup N and PE Relay Switch

To comply with local laws and regulations, ensure that the relay inside the back-up port remains closed and the N and PE wires are connected when the inverter is working off-grid.

Step 1 : Tap **Home > Settings > Advanced Settings > Backup N and PE Relay Switch** to set the parameters.

Step 2 : Enable or disable the function based on actual needs.

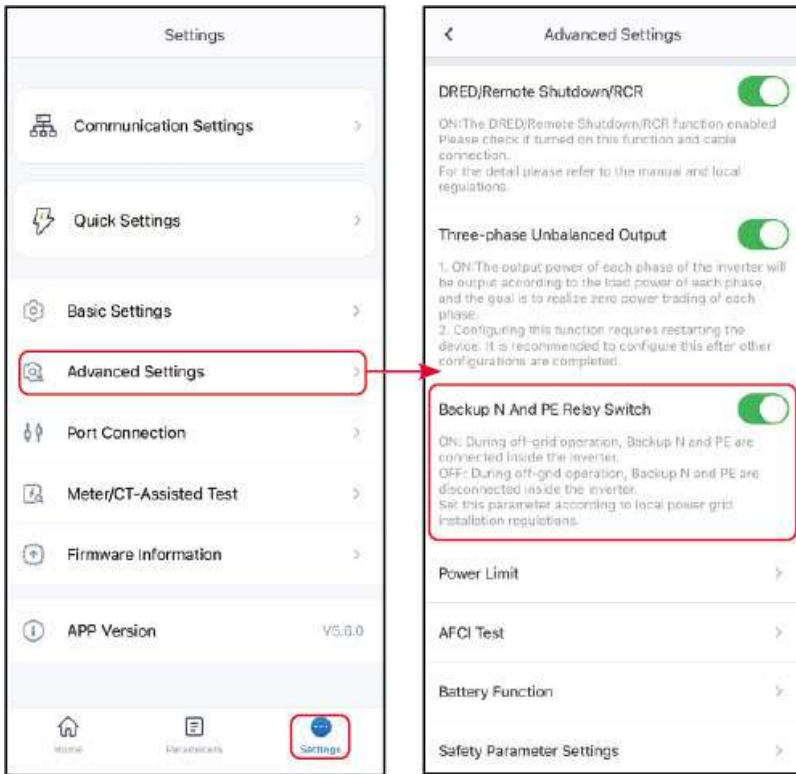

SLG00CON0069

7.2.8.3 Setting DRED/Remote Shutdown/RCR/EnWG 14a

Enable DRED/Remote Shutdown/RCR before connecting the third party DRED, remote shutdown, or RCR device to comply with local laws and regulations.

Step 1 : Tap **Home > Settings > Advanced Settings > DRED/Remote Shutdown/RCR** to set the parameters.

Step 2 : Enable or disable the function based on actual needs.

Step 3 : For areas where the EnWG 14a regulation applies, when enabling the RCR function, you need to select the RCR mode according to the actual device type and set the DI port power.

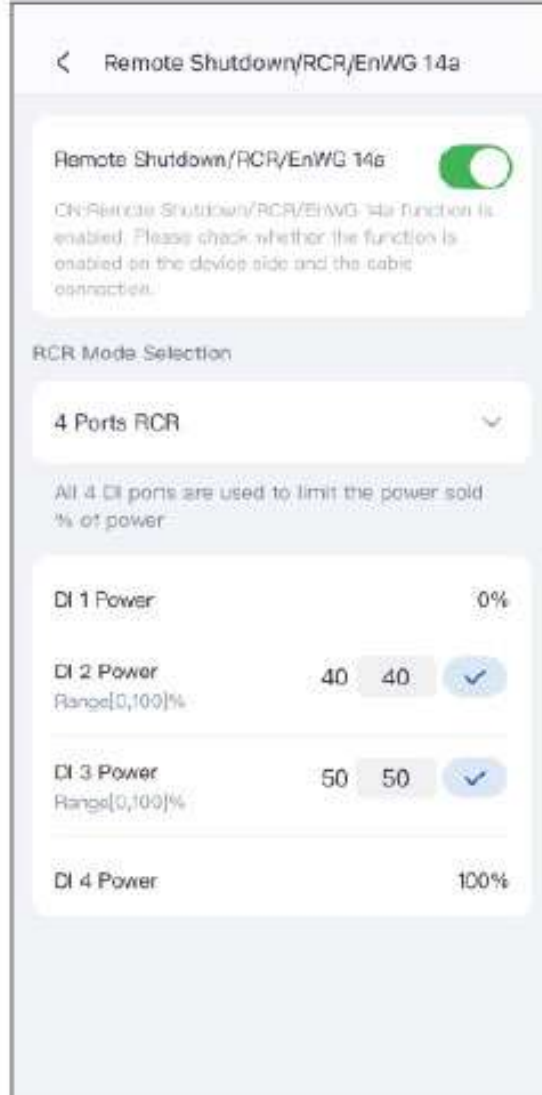

SLG00CON0067

7.2.8.4 Setting the Power Limit Parameters

Step 1: Tap **Home > Settings > Advanced Settings > Power Limit** to set the parameters.

Step 2: Turn on or off the power limit function according to actual needs.

Step 3: After turning on the function, enter the parameter value according to actual needs and tap "v" to successfully set the parameter.

7.2.8.4.1 Set the grid-connected power limit parameters (general)

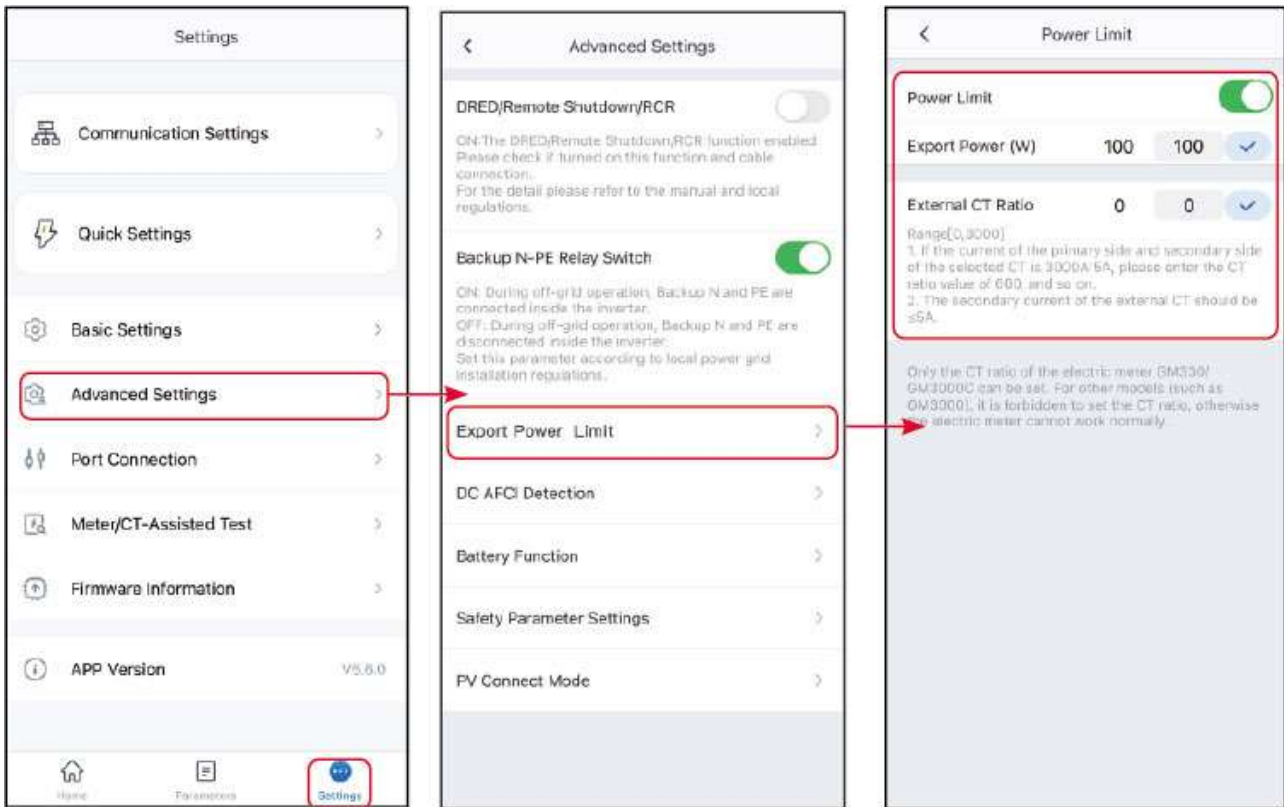

SLG00CON0070

No.	Parameters	Description
1	Power Limit	Turn on this function when output power needs to be limited according to the grid standards of some countries or regions.
2	Export Power	Set according to the maximum power that can be input to the grid.
3	External Meter CT ratio	Set the ratio of the primary current to the secondary current of the external CT.

7.2.8.5 Setting the AFCI Detection

Step 1 : Tap **Home > Settings > Advanced Settings > AFCI Test** to set the parameters.

Step 2 : Enable AFCI Test, Clear AFCI Alarm and Self-Check based on actual needs.

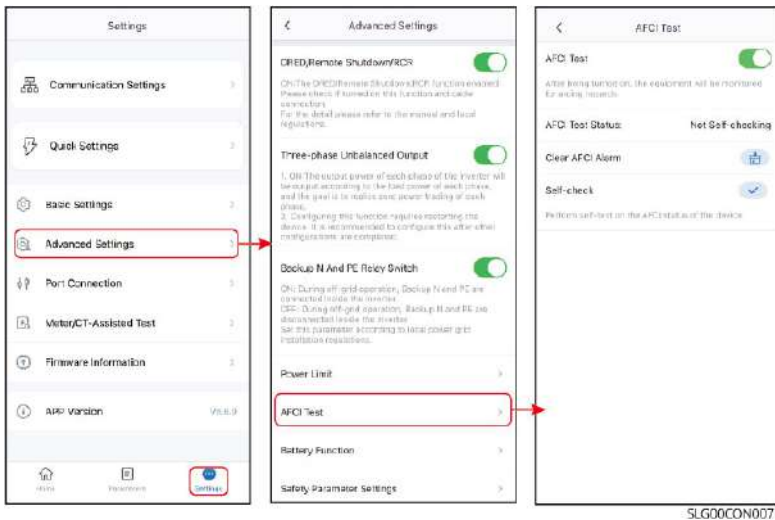

No.	Parameters	Description
1	AFCI Test	Enable or disable AFCI accordingly.
2	AFCI Test Status	The detection status like Not Self-checking.
3	Clear AFCI Alarm	Clear ARC Faulty alarm records.
4	Self-check	Tap to check whether the AFCI function works normally.

7.2.8.6 Setting Power Adjustment Response Parameters

Step 1: Go to the parameter settings page via **Home > Settings > Advanced Settings > Power Adjustment Response Parameters**.

Step 2: Based on actual requirements, select **Disable, Slope Adjustment, or First-Order Low-Pass Filter** Mode from the Active Power Adjustment drop-down menu. If you select slope adjustment, enter the power change gradient value; if you select first-order low-pass filter mode, enter the first-order low-pass filter time parameter value.

Step 3: Based on actual requirements, select **Disable, Slope Adjustment, or First-Order Low-Pass Filter** Mode from the Reactive Power Adjustment drop-down menu. If you select slope adjustment, enter the power change gradient value; if you select first-order low-pass filter mode, enter the first-order low-pass filter time parameter value.

Step 4: Click ✓ to save the settings.



SLG00CON0125

No.	Parameter	Description
Active Adjustment Response Mode		
1	First-order Low-pass Filter	Within the response time constant, active adjustment is implemented according to a first-order low-pass curve.
2	First-order Low-pass Filter Time Parameter	Set the time constant within which the active power changes based on the first order LPF curve.
3	Slope Adjustment	Implement active power dispatch based on the power change slope.
4	Power Change Gradient	Set the slope of active power adjustment changes.
Reactive Adjustment Response Mode		

No.	Parameter	Description
5	First-order Low-pass Filter	Within the response time constant, reactive adjustment is implemented according to a first-order low-pass curve.
6	First-order Low-pass Filter Time Parameter	Set the time constant within which the reactive power changes based on the first order LPF curve.
7	Slope Adjustment	Implement reactive power dispatch based on the power change slope.
8	Power Change Gradient	Set the slope of reactive power adjustment changes.

7.2.8.7 Setting Safety Parameters

NOTICE

Set the custom safety parameters in compliance with local requirements. Do not change the parameters without the prior consent of the grid company.

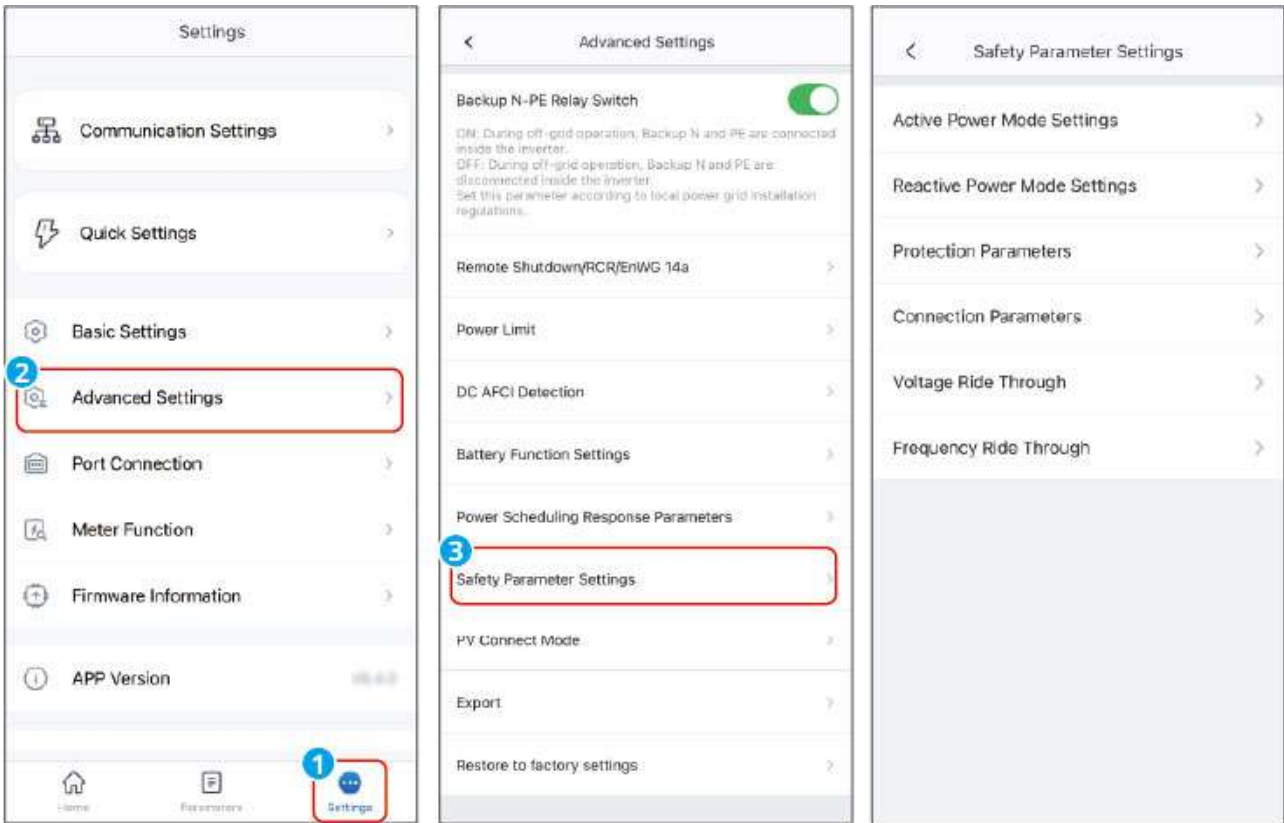

SLG00CON0076

7.2.8.7.1 Setting the Reactive Power Mode

Step 1 : Tap **Home > Settings > Advanced Settings > Safety Parameter Setting > Reactive Power Mode Settings** to set the parameters.

Step 2 : Set the parameters based on actual needs.

Q(U) Curve

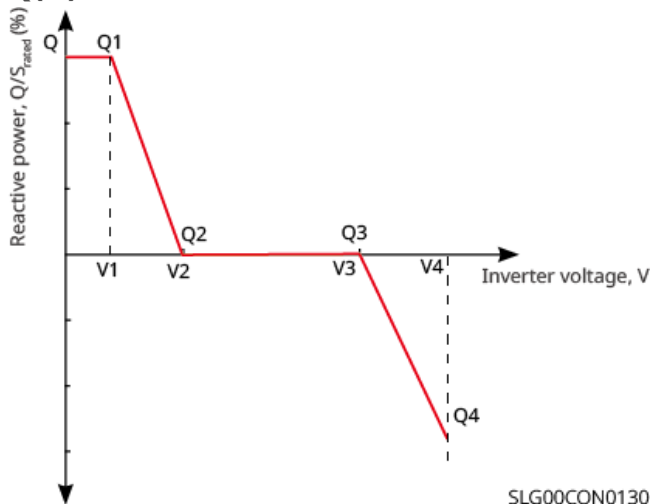

SLG00CON0130

Cosφ Curve

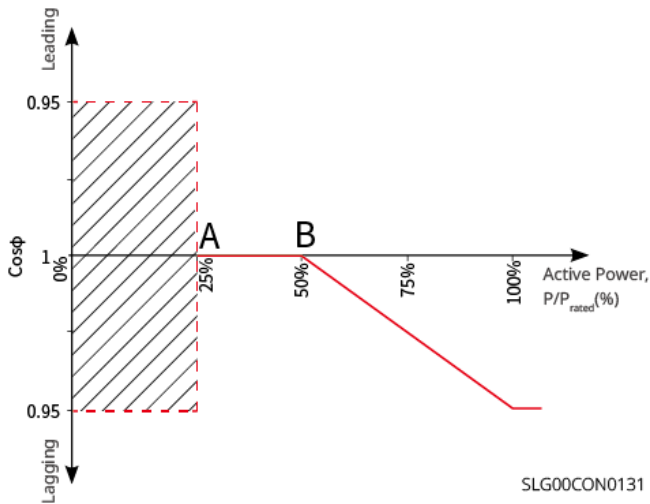

No.	Parameters	Description
Fix PF		
1	Fix PF	Enable Fix PF when it is required by local grid standards and requirements. After the parameters are set successfully, the power factor remains unchanged during the operation of the inverter.
2	Under-excited	Set the power factor as lagging or leading based on actual needs and local grid standards and requirements.
3	Over-excited	
4	Power Factor	Set the power factor based on actual needs. Range: 0~-0.8, or +0.8~+1.
Fix Q		
1	Fix Q	Enable Fix Q when it is required by local grid standards and requirements.
2	Over-excited/Under-excited	Set the reactive power as inductive or capacitive reactive power based on actual needs and local grid standards and requirements.
3	Reactive Power	Set the ratio of reactive power to apparent power.
Q(U) Curve		
1	Q(U) Curve	Enable Q(U) Curve when it is required by local grid standards and requirements.

No.	Parameters	Description
2	Mode Selection	Set Q(U) curve mode, supporting basic mode and slope mode.
3	Vn Voltage	The percentage of actual voltage to the rated voltage at Vn point, n=1, 2, 3, 4. When set to 90, it means: $V/V_{rated}\% = 90\%$.
4	Vn Reactive Power	The percentage of the reactive output power to the apparent power at Vn point, n=1, 2, 3, 4. For example, setting Vn Reactive Power to 48.5 means $Q/S_{rated}\%=48.5\%$.
5	Voltage Deadband Width	When Q(U) curve mode is set to slope mode, this parameter defines the voltage deadband range where no reactive power output is required.
6	Over-excitation Slope	(In Q(U) slope mode) Sets the positive or negative slope for reactive power variation during over-voltage conditions.
7	Under-excitation Slope	
8	Vn Reactive Power	The percentage of the reactive output power to the apparent power at Vn point, n=1, 2, 3, 4. For example, setting Vn Reactive Power to 48.5 means $Q/S_{rated}\%=48.5\%$.
9	Q(U) Curve Response Time Constant	The reactive power must reach 95% of the target value within 3 time constants, following a first-order low-pass filter curve.
10	Extended Function	Enable the extended function and configure the corresponding parameters.
11	Lock-In Power	When the inverter output reactive power to the rated power ratio is between the Lock-in power and Lock-out power, the ratio meets Q(U) curve requirements.
12	Lock-out Power	
Cosφ(P) Curve		

No.	Parameters	Description
1	Cosφ(P) Curve	Enable Cosφ Curve when it is required by local grid standards and requirements.
2	Mode Selection	Set cosφ(P) Curve Mode and support basic mode and slope mode configurations.
3	N-point Power	The percentage of inverter output active power relative to rated power at the N-point. N=A, B, C, D, E.
4	N-point cosφ Value	N-point Power Factor N=A, B, C, D, E.
5	Over-excitation Slope	When cosφ(P) curve mode is set to slope mode, configures the power variation slope as either positive or negative.
6	Under-excitation Slope	
7	N-point Power	The percentage of inverter output active power relative to rated power at the N-point. N=A, B, C.
8	N-point cosφ Value	N-point Power Factor N=A, B, C.
9	cosφ(P) Curve Response Time Constant	The reactive power must reach 95% of the target value within 3 time constants, following a first-order low-pass filter curve.
10	Extended Function	Enable the extended function and configure the corresponding parameters.
11	Lock-in Voltage	When the grid voltage is between Lock-in Voltage and Lock-out Voltage, the voltage meets Cosφ curve requirements.
12	Lock-out Voltage	
Q(P) Curve		
1	Q(P) Curve Function	Enable Q(P) Curve when it is required by local grid standards and requirements.
2	Mode Selection	Set Q(P) curve mode, supporting basic mode and slope mode.

No.	Parameters	Description
3	Pn-point Power	The percentage of the output reactive power to the rated power at Pn point, n=1, 2, 3, 4, 5, 6. For example, setting to 90 means $Q/Prated\%=90\%$.
4	Pn-point Reactive Power	The percentage of the output active power to the rated power at Pn point, n=1, 2, 3, 4, 5, 6. For example, When set to 90, it means: $P/Prated\% = 90\%$.
5	Over-excitation Slope	When the Q(P) curve mode is set to slope mode, configure the power variation slope as either a positive or negative value.
6	Under-excitation Slope	
7	Pn-point Power	Ratio of reactive power to rated power at Pn points (n=1, 2, 3). For example, setting to 90 means $Q/Prated\%=90\%$.
8	Pn-point Reactive Power	Ratio of active power to rated power at Pn points (n=1, 2, 3). For example, When set to 90, it means: $P/Prated\% = 90\%$.
9	Time Constant	The reactive power must reach 95% of the target value within 3 time constants, following a first-order low-pass filter curve.

7.2.8.7.2 Setting the Active Power Mode

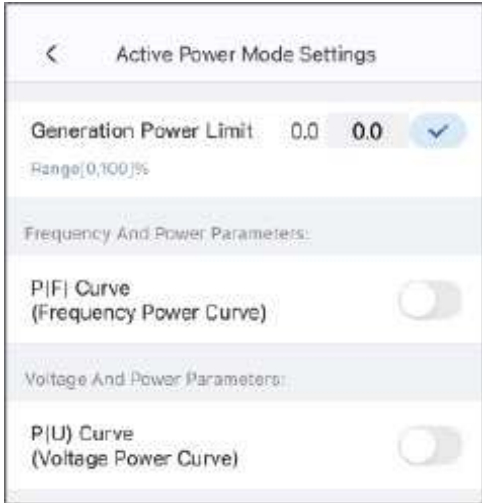

SLG00CON0149

Step 1: Tap **Home > Settings > Advanced Settings > Safety Parameter Settings > Active Power Mode Settings** to set the parameters.

Step 2: Set the parameters based on actual needs.

P(F) Curve

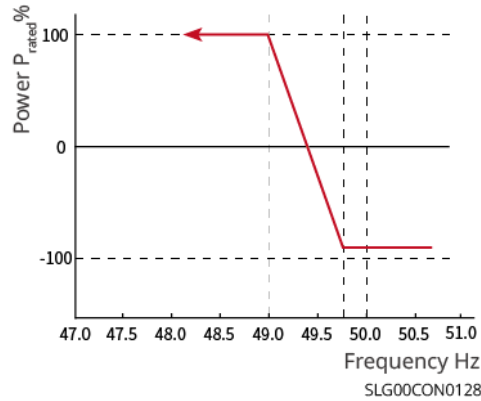
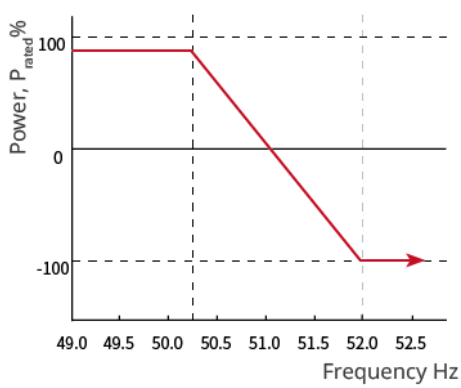

SLG00CON0128

P(U) Curve

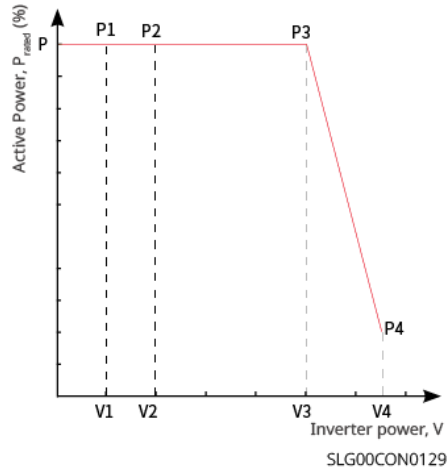

SLG00CON0129

No.	Parameters	Explanation
1	Generation Power Limit	Set the change slope when the active output power increases or decreases.
2	Power Gradient	Set the active power change slope.
Overfrequency Unloading		
1	P(F) Curve	Enable P(F) Curve when it is required by local grid standards and requirements.
2	Over-Frequency Load Shedding Mode	Set the overfrequency unloading mode based on actual needs. <ul style="list-style-type: none"> • Slope mode: adjusts power based on the over frequency point and load reduction slope. • Stop mode: adjusts the power based on the over-frequency start point and over-frequency end point.
3	Overfrequency Threshold	The inverter output active power will decrease when the utility grid frequency is too high. The inverter output power will decrease when the utility grid frequency is higher than Overfrequency Threshold .
4	Import/Export Electricity Conversion Frequency	When the set frequency value is reached, the system switches from selling electricity to buying electricity.
5	Overfrequency Endpoint	The inverter output active power will decrease when the utility grid frequency is too high. The inverter output power will stop decreasing when the utility grid frequency is higher than Overfrequency Endpoint .

No.	Parameters	Explanation
6	Over-Frequency Power Slope Reference Power	Adjust the inverter output power based on Apparent Active Power, Rated Active Power, Momentary Active Power, Or Max. Active Power.
7	Power response to overfrequency gradient	The inverter output active power will increase when the utility grid frequency is too high. Indicates the slope when the inverter output power decreases.
8	Tentential Delay Ta	Indicates the delayed response time when the inverter output power is higher than the Overfrequency Threshold .
9	Hysteretic Function	Enable the hysteretic function.
10	Frequency Hysteresis Point	During over-frequency load reduction, if the frequency decreases, the power output is based on the lowest point of the load reduction power until the frequency is less than the hysteresis point and the power is restored.
11	Hysteresis Waiting Time	For over-frequency load reduction and frequency decrease, when the frequency is less than the hysteresis point, the power recovery waiting time, that is, it takes a certain amount of time to recover the power.
12	Hysteresis Power Recovery Slope Reference Power	For over-frequency load reduction and frequency decrease, when the frequency is less than the hysteresis point, the power recovery benchmark, that is, the power recovery is based on the recovery slope * the rate of change of the reference power. Support: Pn rated power, Ps apparent power, Pm current power, Pmax maximum power, power difference (ΔP).

No.	Parameters	Explanation
13	Hysteretic Power Recovery Slope	For over-frequency load reduction and frequency reduction, when the frequency is less than the hysteresis point, the power change slope when the power is restored.
Underfrequency Loading		
1	P(F) Curve	Enable P(F) Curve when it is required by local grid standards and requirements.
2	Underfrequency Load Mode	Set the underfrequency unloading mode based on actual needs. <ul style="list-style-type: none"> • Slope mode: adjusts power based on the underfrequency point and load increase slope. • Stop mode: adjusts the power based on the underfrequency start point and underfrequency end point.
3	Underfrequency Threshold	The inverter output active power will increase when the utility grid frequency is too low. The inverter output power will increase when the utility grid frequency is lower than Underfrequency Threshold.
4	Import/Export Electricity Conversion Frequency	When the set frequency value is reached, the system switches from selling electricity to buying electricity.
5	Underfrequency Endpoint	The inverter output active power will increase when the utility grid frequency is too low. The inverter output power will stop increasing when the utility grid frequency is lower than Underfrequency Endpoint.

No.	Parameters	Explanation
6	Over-Frequency Power Slope Reference Power	Adjust the inverter output power based on Apparent Active Power, Rated Active Power, Momentary Active Power, Or Max. Active Power.
7	Under-Frequency Power Slope	The inverter output active power will increase when the utility grid frequency is too low. The slope of the inverter output power when it rises.
8	Tentional Delay Ta	Indicates the delayed response time when the inverter output power is lower than the Underfrequency Threshold .
9	Hysteretic Function	Enable the hysteretic function.
10	Frequency Hysteresis Point	During underfrequency loading, if the frequency increases, the power is output according to the lowest point of the loaded power until the frequency is higher than the hysteresis point and the power is restored.
11	Hysteresis Waiting Time	For underfrequency loading, the frequency increases, when the frequency is higher than the hysteresis point, the waiting time for power recovery, that is, it takes a certain amount of time to recover the power.
12	Hysteresis Power Recovery Slope Reference Power	For underfrequency loading, the frequency increases, when the frequency is higher than the hysteresis point, the benchmark for power recovery, that is, the power recovery is carried out according to the recovery slope * the rate of change of the benchmark power. Support: Pn rated power, Ps apparent power, Pm current power, Pmax maximum power, power difference (ΔP).

No.	Parameters	Explanation
13	Hysteretic Power Recovery Slope	For under-frequency loading, frequency increase, when the frequency is higher than the hysteresis point, the power change slope when power is restored.
14	P(U) Curve	Enable P(U) Curve when it is required by local grid standards and requirements.
15	Vn Voltage	The percentage of actual voltage to the rated voltage at Vn point, n= 1, 2, 3, 4. For example, setting Vn Voltage to 90 means $V/V_{rated}\%=90\%$.
16	Vn Active Power	The percentage of the output active power to the apparent power at Vn point, (n= 1, 2, 3, 4). For example, setting Vn Reactive Power to 48.5 means $P/P_{rated}\%=48.5\%$.
17	Output Response Mode	Set the active power output response mode. Supports: <ul style="list-style-type: none"> • PT-1 Behavior, realize active scheduling based on the first-order LPF curve within the response time constant. • Gradient Control, realize active scheduling based on the power change slope.
18	Power Gradient	When the output response mode is set to Gradient Control, active power scheduling is achieved according to the power change gradient.
19	First-order Low-pass Filter Time Parameter	Set the time constant within which the active power changes based on the first order LPF curve when the Output Response Mode is set to be First-order Low-pass Filter Time Parameter.
20	Overload Function Switch	When enabled, the maximum active power output is 1.1 times the rated power; otherwise, the maximum active power output is consistent with the rated power value.

7.2.8.7.3 Setting Protection Parameters

Step 1 : Tap **Home > Settings > Advanced Settings > Safety Parameter Settings >**

Protection Parameters to set the parameters.

Step 2: Set the parameters based on actual needs.

No.	Parameters	Description
1	OV Stage n Trip Value	Set the grid overvoltage protection threshold value, n=1,2,3,4.
2	OV Stage n Trip Time	Set the grid overvoltage protection tripping time, n=1,2,3,4.
3	UV Stage n Trip Value	Set the grid undervoltage protection threshold value, n=1,2,3,4.
4	UV Stage n Trip Time	Set the grid undervoltage protection tripping time.
5	10min Overvoltage Trip Threshold	Set the 10min overvoltage protection threshold value.
6	10min Overvoltage Trip Time	Set the 10min overvoltage protection tripping time.
7	OF Stage n Trip Value	Set the grid overfrequency triggering n-th order protection point, n=1,2,3,4.
8	OF Stage n Trip Time	Set the grid overfrequency trigger n-th order trip time, n=1,2,3,4.
9	UF Stage n Trip Value	Set the grid underfrequency triggering n-th order protection point, n=1,2,3,4.
10	UF Stage n Trip Time	Set the grid underfrequency trigger n-th order trip time, n=1,2,3,4.

7.2.8.7.4 Setting Connection Parameters

Step 1 : Tap **Home > Settings > Advanced Settings > Safety Parameter Settings > Protection Parameters** to set the parameters.

Step 2: Set the parameters based on actual needs.

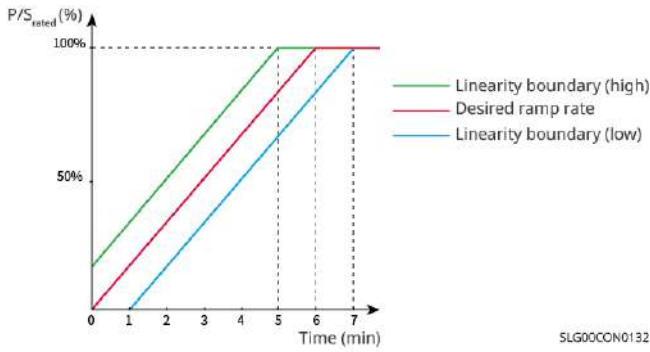

No.	Parameters	Description
Ramp Up		
1	Upper Voltage	The inverter cannot connect to the grid if it is powered on for the first connection and the grid voltage is higher than the Upper Voltage .
2	Lower Voltage	The inverter cannot connect to the grid if it is powered on for the first connection and the grid voltage is lower than the Lower Voltage .
3	Upper Frequency	The inverter cannot connect to the grid if it is powered on for the first connection and the grid frequency is higher than the Upper Frequency .
4	Lower Frequency	The inverter cannot connect to the grid if it is powered on for the first connection and the grid frequency is lower than the Lower Frequency .
5	Observation Time	The waiting time for connecting the inverter to the grid when meeting the following requirements. 1. The inverter is powered on for the first connection. 2. The utility grid voltage and frequency meet certain requirements.
6	Soft Ramp Up Gradient	Enable the start up power slope.
7	Soft Ramp Up Gradient	Indicates the percentage of incremental output power per minute based on the local requirements when the inverter is powered on for the first time.
Reconnection		

No.	Parameters	Description
8	Upper Voltage	The inverter cannot connect to the grid if it is reconnecting due to a fault and the grid voltage is higher than the Upper Voltage .
9	Lower Voltage	The inverter cannot connect to the grid if it is reconnecting due to a fault and the grid voltage is lower than the Lower Voltage .
10	Upper Frequency	The inverter cannot connect to the grid if it is reconnecting due to a fault and the grid frequency is higher than the Upper Frequency .
11	Lower Frequency	The inverter cannot connect to the grid if it is reconnecting due to a fault and the grid frequency is lower than the Lower Frequency .
12	Observation Time	The waiting time for connecting the inverter to the grid when meeting the following requirements. 1. The inverter is reconnecting to the grid due to a fault. 2. The utility grid voltage and frequency meet certain requirements.
13	Reconnection Gradient	Enable the start up power slope.
14	Reconnection Gradient	Indicates the percentage of incremental output power per minute based on the local requirements when the inverter is powered on for the first time. For example, setting Reconnection Gradient to 10 means the reconnect slope is 10%P/Srated/min.

7.2.8.7.5 Setting Voltage Ride Through Parameters

Step 1 : Tap **Home** > **Settings** > **Advanced Settings** > **Safety Parameter Settings** > **Voltage Ride Through** to set the parameters.

Step 2 : Set the parameters based on actual needs.

No.	Parameters	Description
LVRT		
1	UVn Voltage	The ratio of the ride through voltage to the rated voltage at UVn point during LVRT. n=1,2,3,4,5,6,7。
2	UVn Time	The ride through time at UVn point during LVRT. n=1,2,3,4,5,6,7
3	Enter Into LVRT Threshold	The inverter will not be disconnected from the utility grid immediately when the grid voltage is between Enter Into LVRT Threshold and Exit LVRT Endpoint.
4	Exit LVRT Endpoint	
5	Slope K2	K-factor for reactive power during LVRT.
6	Zero Current Mode	The system outputs zero current during LVRT.
7	Entry Threshold	Set the entry threshold of zero current mode.
HVRT		
1	OVn Voltage	The ratio of the ride through voltage to the rated voltage at OVn point during HVRT. n=1,2,3,4,5,6,7。
2	OVn Time	The ride through time at OVn point during HVRT. n=1,2,3,4,5,6,7。
3	Enter High Crossing Threshold	The inverter will not be disconnected from the utility grid immediately when the grid voltage is between Enter High Crossing Threshold and Exit High Crossing Threshold.
4	Exit High Crossing Threshold	
5	Slope K2	K-factor for reactive power during HVRT.

No.	Parameters	Description
6	Zero Current Mode	The system outputs zero current during HVRT.
7	Entry Threshold	Set the entry threshold of zero current mode.

7.2.8.7.6 Setting Frequency Ride Through Parameters

Step 1 : Tap **Home > Settings > Advanced Settings > Safety Parameter Settings > Frequency Ride Through** to set the parameters.

Step 2 : Set the parameters based on actual needs.

No.	Parameters	Description
1	UFn Frequency	The frequency at the UFn point during frequency ride through.
2	UFn Frequency	The frequency at the UFn point during frequency ride through. n=1,2,3.
3	UFn Time	The ride through duration at the UFn point during frequency ride through. n=1,2,3.
4	OFn Frequency	The frequency at the OFn point during frequency ride through. n=1,2,3.
5	OFn Time	The ride through duration at the OFn point during frequency ride through. n=1,2,3.

7.2.8.8 Setting PV Connect Mode

Select the PV connect mode based on the actual connections between the PV strings and MPPT ports of the inverter.

Step 1 : Tap **Home > Settings > Advanced Settings > PV Connect Mode** to set the parameters.

Step 2 : Set the connect mode to Independent Access, Partial Parallel Connect or Parallel Connection based on actual connections.

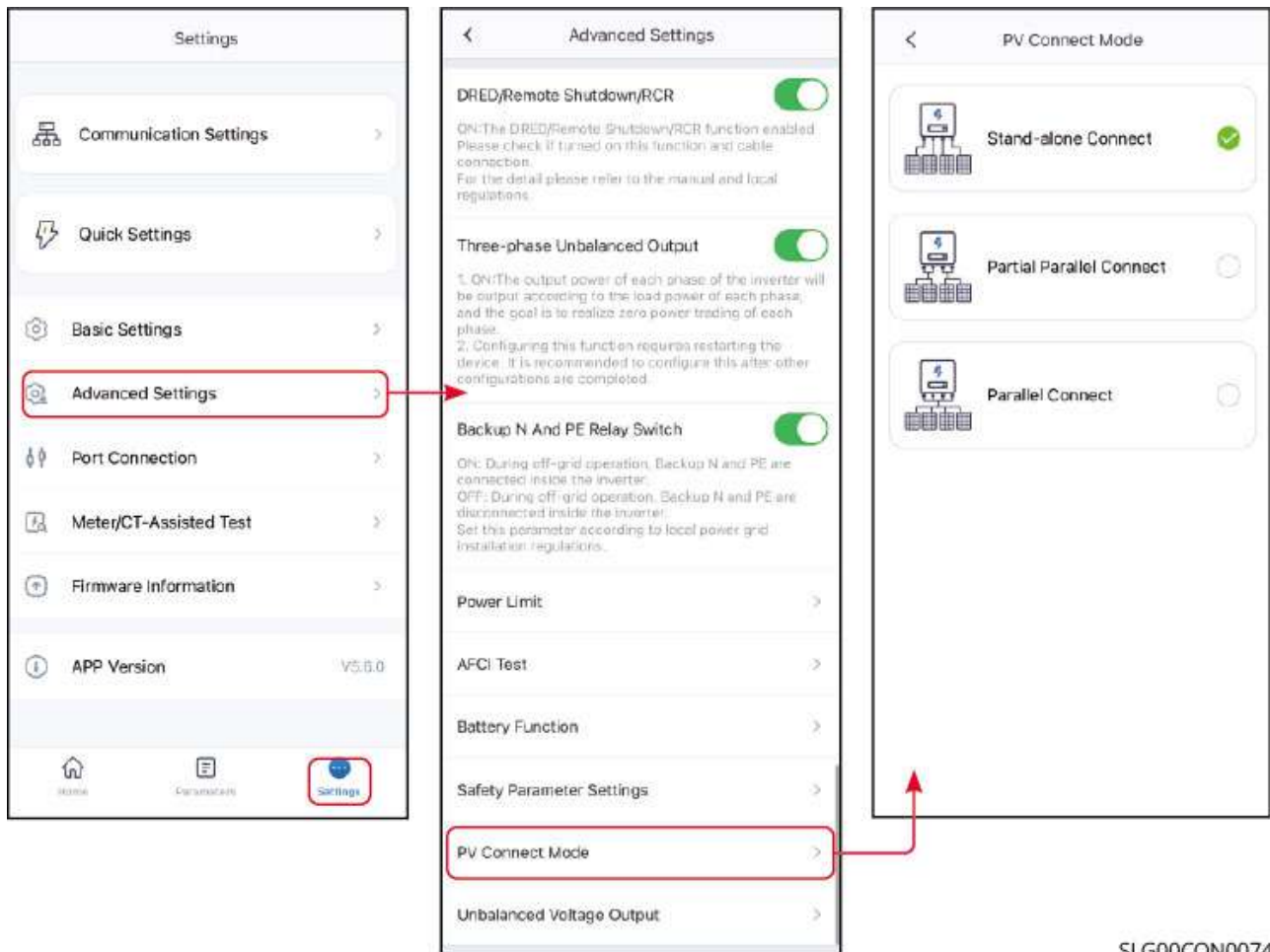

SLG00CON0074

No.	Parameters	Description
1	Stand-alone Connect	The external PV string is connected to multi MPPT terminals of the inverter.
2	Partial Parallel Connect	The PV strings are connected to the inverter in both stand-alone and parallel connection. For example, one PV string connect to MPPT1 ad MPPT2, another PV string connect to MPPT3.
3	Parallel Connect	When an external PV string is connected to the PV input port on the inverter side, one PV string is connected to multiple PV input ports.

7.2.8.9 Setting the Unbalanced Voltage Output

Step 1 : Tap **Home > Settings > Advanced Settings > Unbalanced Voltage Output** to see the parameters.

Step 2 : Enable or disable the function based on actual needs.

Step 3 : After enabling the Unbalance Voltage Function, set parameters based on actual needs. And tap 'V'. The parameters are set successfully.

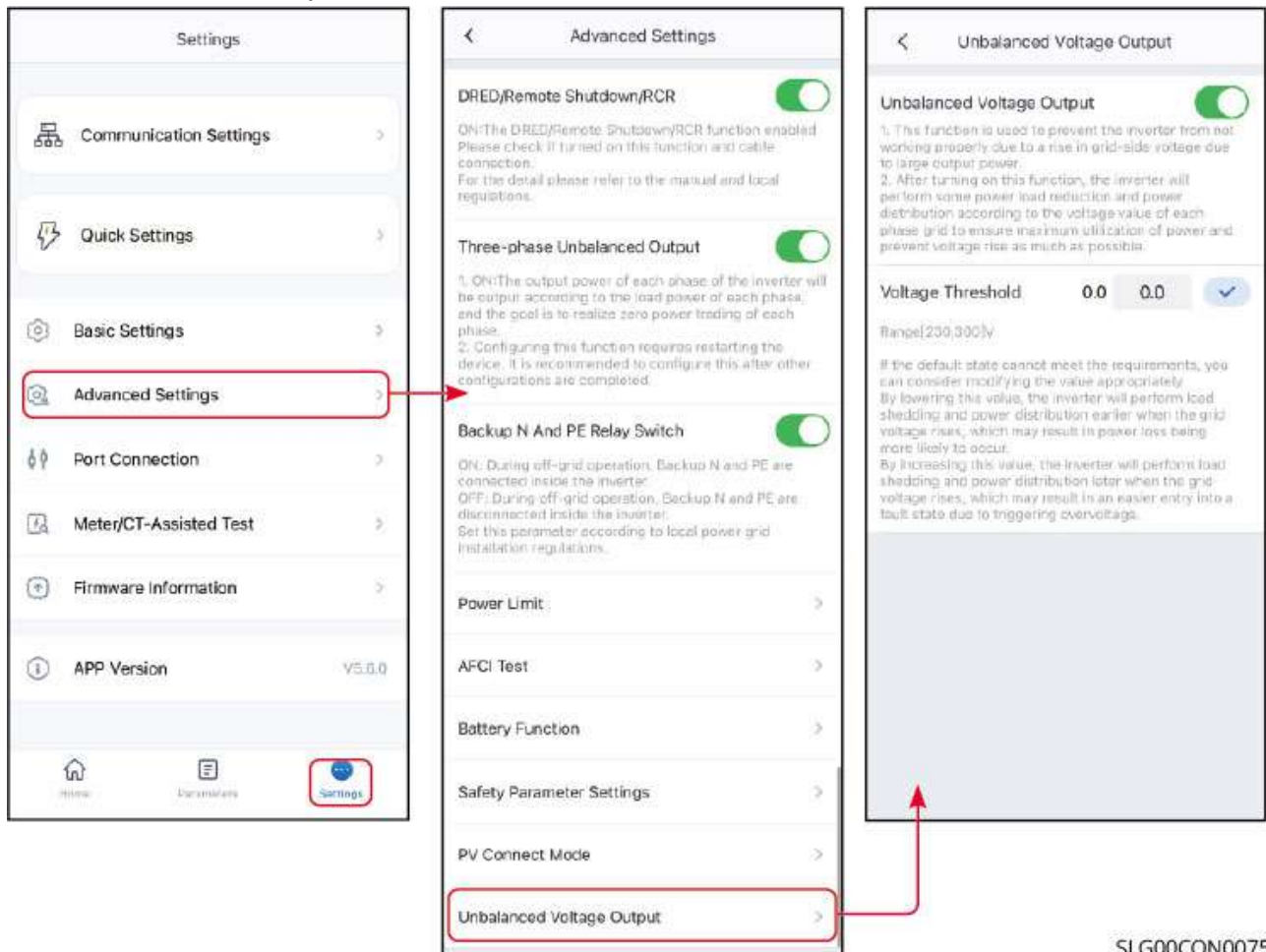

7.2.8.10 Restore Factory Settings

To restore the device to its factory default settings, perform the following steps.

Step 1: Go to the settings page by selecting **Home > Settings > Advanced Settings > Restore Factory Settings**.

Step 2: Tap **Restore Factory Settings** to restore the interface prompt section to factory settings.

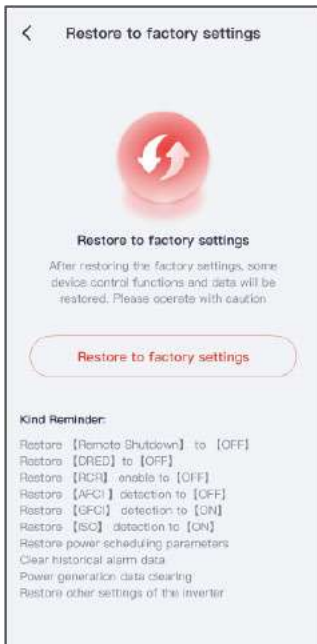

SLG00CON0122

7.2.8.11 Exporting Parameters

7.2.8.11.1 Exporting Safety Parameters

After selecting the safety code, some models support exporting safety parameter files.

Step 1 : Tap **Home > Settings > Advanced Settings > Export** to export the parameters.

Step 2 : Select Safety Parameters, and tap **Export** to start downloading the current safety parameter file. When the export is complete, tap **Share** and choose how you want to open the exported file.

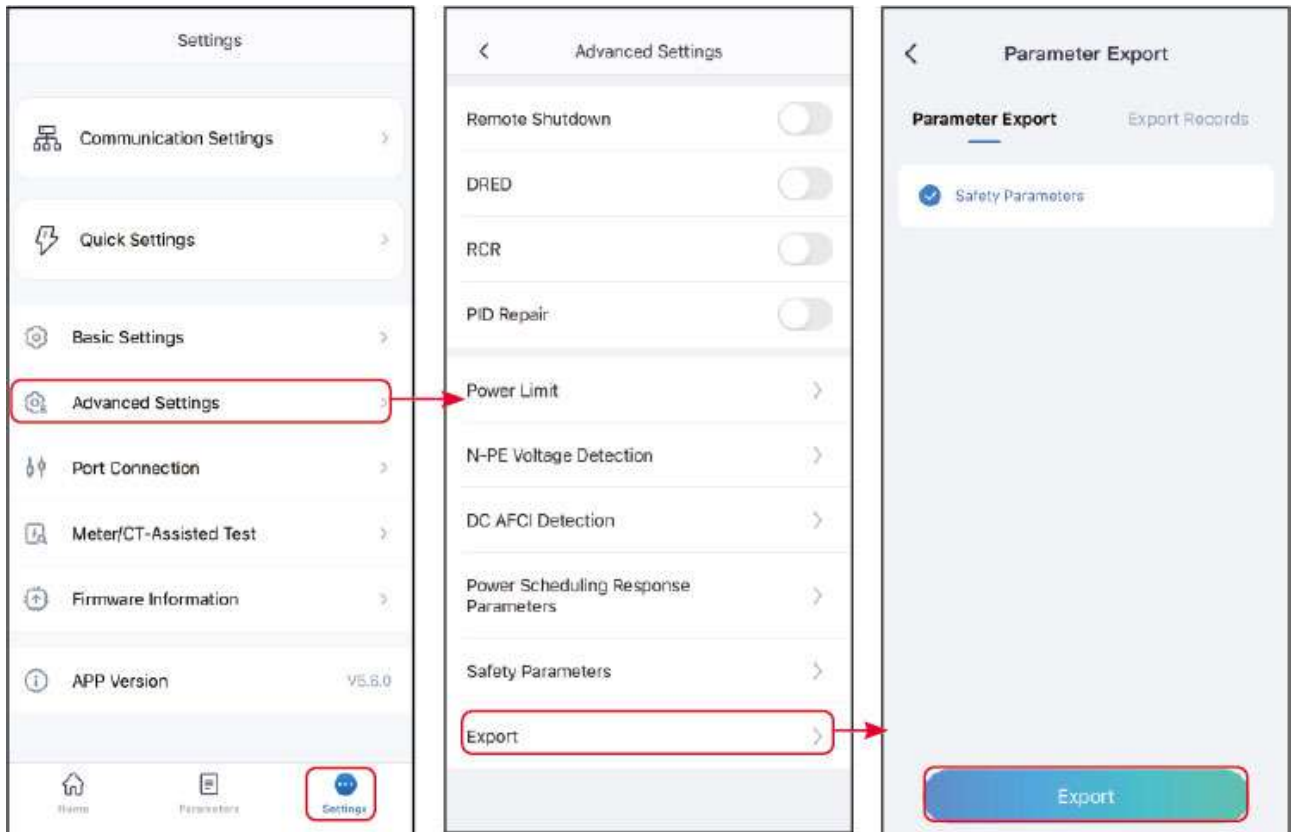

SLG00CON0077

7.2.8.11.2 Exporting Log Parameters

Step 1 : Tap **Home** > **Settings** > **Advanced Settings** > **Export**.

Step 2 : Select the device type to export logs, such as inverter logs, communication module logs, etc.

Step 3: Select the log type to export, download and export the log file. After the export is complete, tap **Share** and choose how to open the exported file according to actual needs.

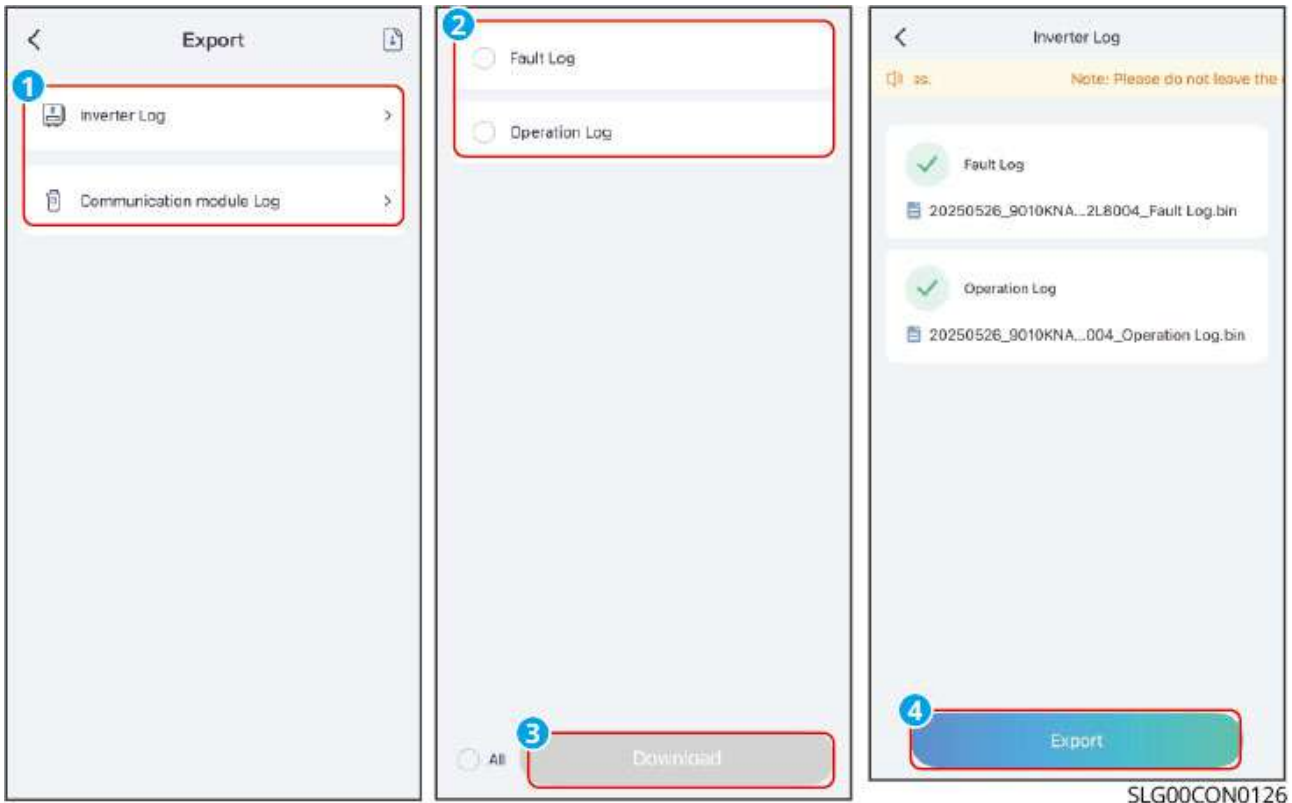

7.2.9 Setting the Battery

7.2.9.1 Set Parameters for Lithium Battery

Step 1: Tap **Home > Settings > Advanced Settings > Battery Function Settings** to set the parameters.

Step 2: Set the parameters based on actual needs.

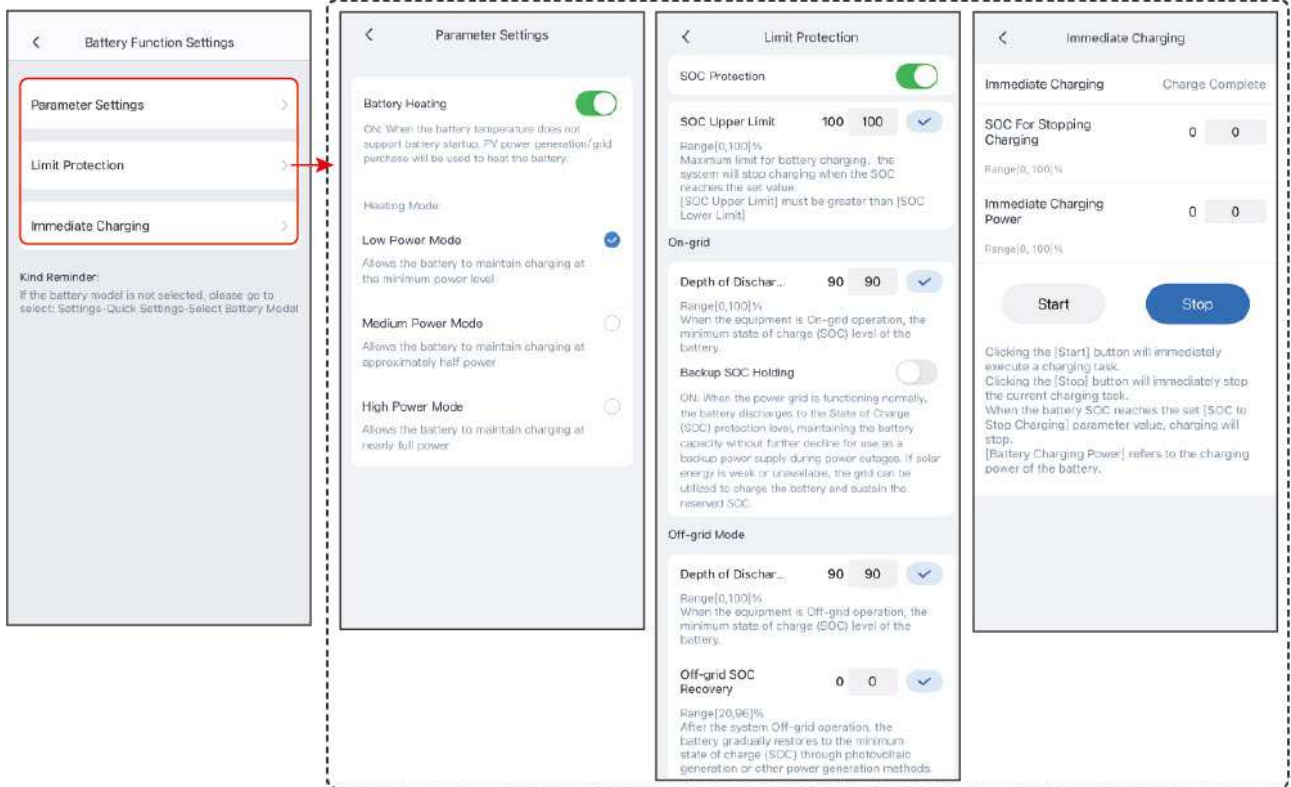

SLG00CON0072

No.	Parameter	Description
Parameter Settings		
1	Max. Charging Current	Only applicable to certain models. Set the maximum charging current based on actual needs.
2	Max. Discharging Current	Only applicable to certain models. Set the maximum discharging current based on actual needs.

No.	Parameter	Description
3	Battery Heating	<p>Optional. This option is displayed on the interface when a battery that supports heating is connected. After the battery heating function is turned on, when the temperature is below the value that starts up the battery, PV power or electricity from the grid will be used to heat the battery.</p> <p>Heating Mode:</p> <ul style="list-style-type: none"> • GW5.1-BAT-D-G20/GW8.3-BAT-D-G20 <ul style="list-style-type: none"> ◦ Low Power Mode: Maintains minimum battery power input capacity, turns on when the temperature is below -9°C, and turns off when the temperature is above or equal to -7°C. ◦ Medium Power Mode: to maintain the moderate power input capacity of the battery. It will be turned on when the temperature is less than 6°C, and turned off when it is greater than or equal to 8°C. ◦ High Power Mode: to maintain the higher power input capacity of the battery. It will be turned on when the temperature is less than 11°C, and turned off when it is greater than or equal to 13°C. • GW14.3-BAT-LV-G10 <ul style="list-style-type: none"> ◦ Low Power Mode: Maintains minimum battery power input capacity, turns on when the temperature is below 5°C, and turns off when the temperature is above or equal to 7°C. ◦ Medium Power Mode: to maintain the moderate power input capacity of the battery. It will be turned on when the temperature is less than 10°C, and turned off when it is greater than or equal to 12°C. ◦ High Power Mode: to maintain the higher power input capacity of the battery. It will be turned on when the temperature is less than 20°C, and turned off when it is greater than or equal to 22°C.

No.	Parameter	Description
4	Battery Wake-up	<ul style="list-style-type: none"> After being turned on, the battery can be awakened when it shuts down due to undervoltage protection. Only applicable to lithium batteries without circuit breakers. After being turned on, the output voltage of the battery port is about 60V.
Limit Protection		
5	SOC Protection	Start battery protection when the battery capacity is lower than the Depth of Discharge.
6	SOC Limit	The upper limit value for battery charging. Charging stops when the battery SOC reaches the SOC upper limit.
7	Discharge Depth (On-grid)	The maximum discharge value allowed for the battery when the inverter is in the on-grid scenario.
8	Backup Power SOC Maintenance	To ensure that the battery SOC is sufficient to maintain normal operation when the system is off-grid, the battery will purchase electricity from the grid and charge to the set SOC protection value when the system is connected to the grid.
9	Discharge Depth (Off-grid)	The maximum discharge value allowed for the battery when the inverter is in the off-grid scenario.
10	Off-grid SOC Recovery	When the inverter is operating off-grid, if the battery SOC drops below the lower limit, the inverter stops outputting power and only charges the battery until the battery SOC returns to the off-grid recovery SOC value. If the SOC lower limit value is higher than the off-grid recovery SOC value, charge to SOC lower limit +10%.
Immediate Charging		
11	Immediate Charging	Enable to charge the battery by the grid immediately. This takes effect once. Enable or Disable based on actual needs.

No.	Parameter	Description
12	SOC for Stopping Charging	Stop charging the battery once the battery SOC reaches SOC For Stopping Charging.
13	Immediate Charging Power	Indicates the percentage of the charging power to the inverter rated power when enabling Immediate Charging. For example, for an inverter with a rated power of 10kW, when set to 60, the charging power is 6kW.
14	Start	Start charging immediately.
15	Stop	Immediately stop the current charging task.

7.2.9.2 Setting Lead-acid Battery Parameter

Step 1: Tap **Home > Settings > Advanced Settings > Battery Function Settings** to set the parameters.

Step 2: Set the parameters based on actual needs.

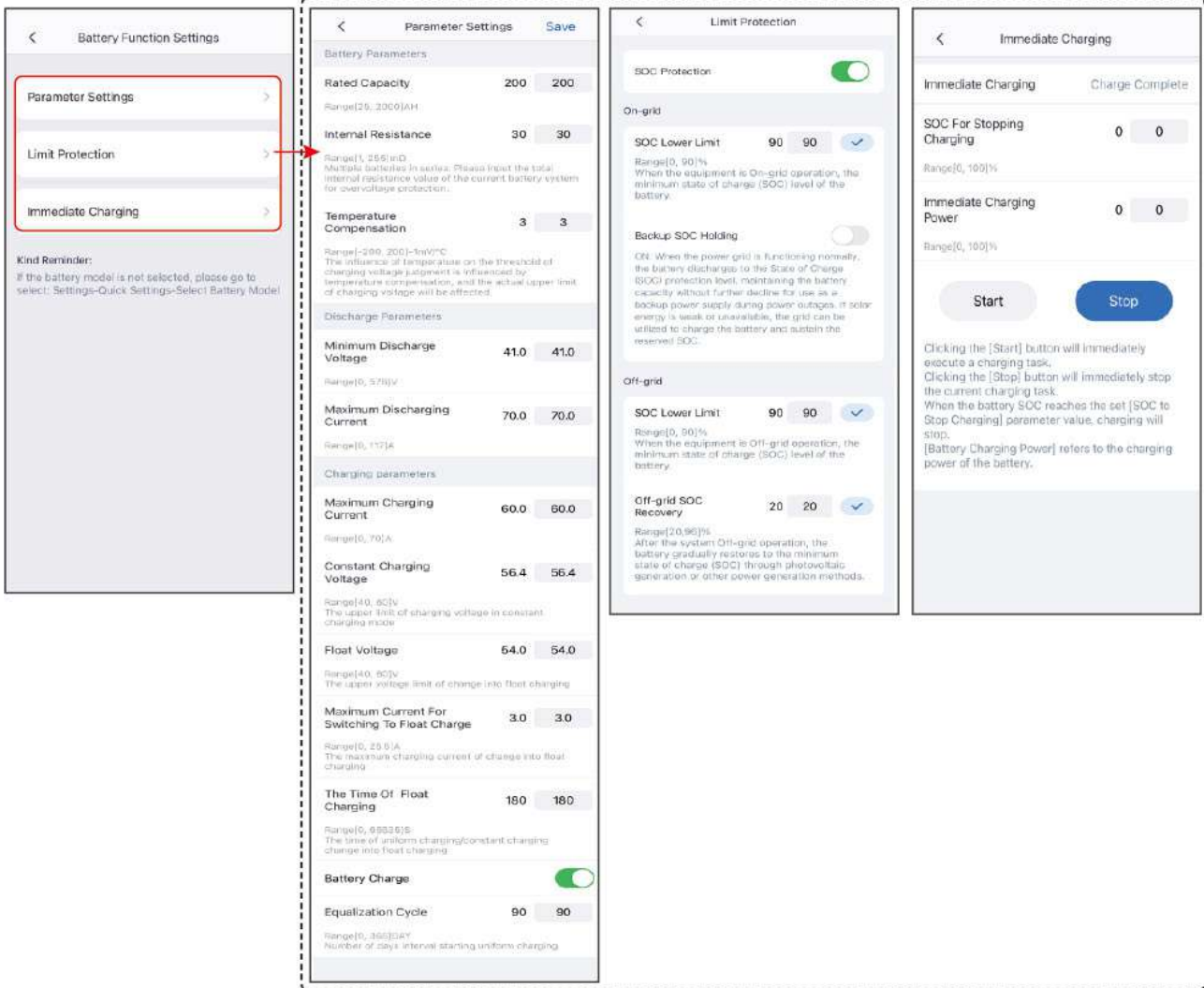

SLG00CON0073

No.	Parameter	Description
Parameter Settings		
1	Nominal Capacity	Set the battery capacity according to the actual parameters.
2	Battery Internal Resistance	Set the battery internal resistance according to the actual parameters.

No.	Parameter	Description
3	Temperature Compensation	<p>When the battery temperature changes, the battery charging voltage will be affected. Based on 25°C, the charging voltage upper limit is adjusted according to the set value for every degree change in battery temperature.</p> <p>For example, if the charging temperature influence coefficient is set to 10, when the battery temperature rises to 26 degrees, the charging voltage upper limit decreases by 10 mV.</p>
4	Lower Discharge Voltage	Set the minimum voltage during battery discharge according to actual requirements.
5	Max. Discharging Current	Set the maximum discharging current based on actual needs.
6	Max. Charging Current	Set the maximum charging current based on actual needs.
7	Constant Charging Voltage	Set the voltage value for constant charging of the battery according to actual requirements.
8	Floating Voltage	Set the voltage value for battery float charging according to actual requirements.
9	Maximum Current When Switching to Floating Charge	The maximum charging current after switching the battery charging mode from constant charging/equal charging to float charging.
10	Time to Switch to Float Charging Mode	The time required to switch the battery charging mode from constant charging/equal charging to float charging.
11	Equalization Charging Cycle	Set the interval days for battery equalization charging.

No.	Parameter	Description
Restriction protection.		
12	SOC Protection	Start battery protection when the battery capacity is lower than the Depth of Discharge.
13	SOC Lower Limit (Grid Connection)	The minimum battery charge that must be maintained when the inverter is connected to the grid.
14	Backup Power SOC Maintenance	To ensure that the battery SOC is sufficient to maintain normal operation when the system is off-grid, the battery will purchase electricity from the grid and charge to the set SOC protection value when the system is connected to the grid.
15	SOC Lower Limit (Off-Grid)	The minimum battery charge that must be maintained when the inverter is operating off-grid.
16	Off-grid SOC Recovery	When the inverter is operating off-grid, if the battery SOC drops below the lower limit, the inverter stops outputting power and only charges the battery until the battery SOC returns to the off-grid recovery SOC value. If the SOC lower limit value is higher than the off-grid recovery SOC value, charge to SOC lower limit +10%.
Immediate Charging		
17	SOC for Stopping Charging	Stop charging the battery once the battery SOC reaches SOC For Stopping Charging.
18	Immediate Charging Power	Indicates the percentage of the charging power to the inverter rated power when enabling Immediate Charging. For example, for an inverter with a rated power of 10kW, when set to 60, the charging power is 6kW.
19	Start	Start charging immediately.
20	Stop	Immediately stop the current charging task.

7.2.10 Setting the Meter Parameters

7.2.10.1 Meter/CT-Assisted Test

Meter/CT-Assisted Test is used to auto-check if the Smart Meter and CT are connected in the right way and their working status.

Step 1 : Tap **Home > Settings > Meter/CT Assisted Test** to set the function.

Step 2 : Tap **Start Test** to start test. Check Test Result after test.

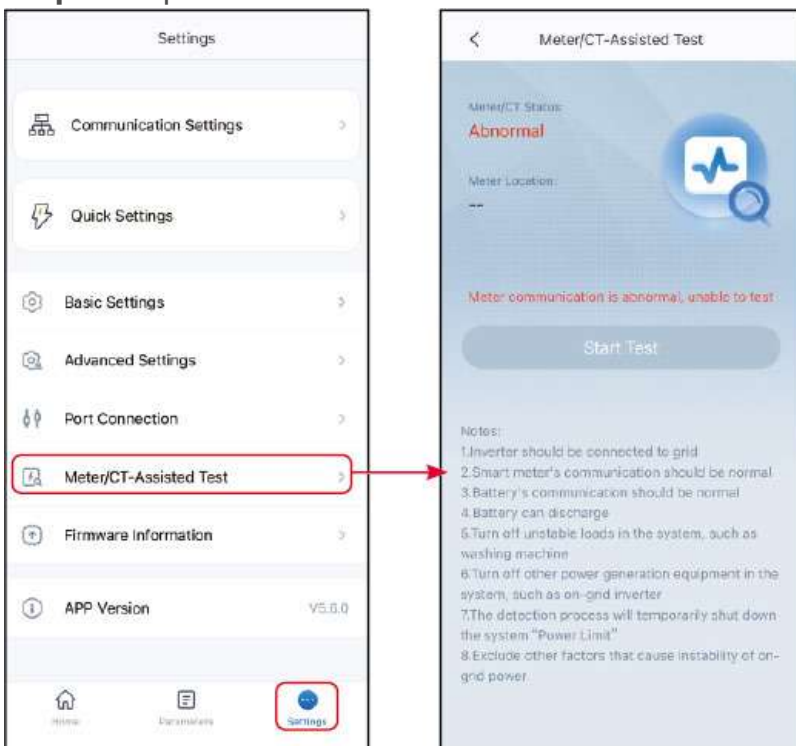

SLG00CON0086

7.2.11 Setting Generator/Load Control

7.2.11.1 Setting Load Control

NOTICE

- Loads and generators can be controlled by SolarGo app when the inverter supports load control function.
- For ET40-50kW series inverters, the load control function is supported only when the inverter is used with STS. The inverter supports load control of the GENERATOR port or the BACKUP LOAD port.

Step 1: Tap **Home > Settings > Port Connection** to set the parameters.

Step 2: Select **Generator Control** or **Load Control** based on actual needs.

- Dry Contact Mode: when the switch is ON, the loads will be powered; when the switch is OFF, the power will be cut off. Turn on or off the switch based on actual needs.

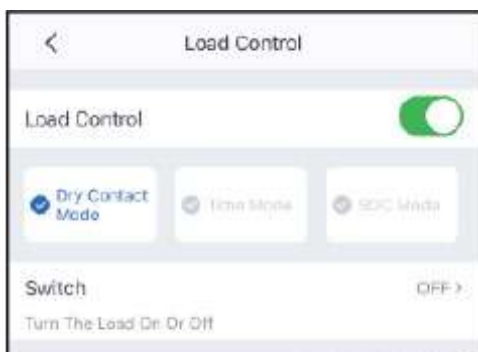

SLG00CON0080

- Time Mode: set the time to enable the load, and the load will be powered automatically within the setting time period. Select standard mode or intelligent mode.

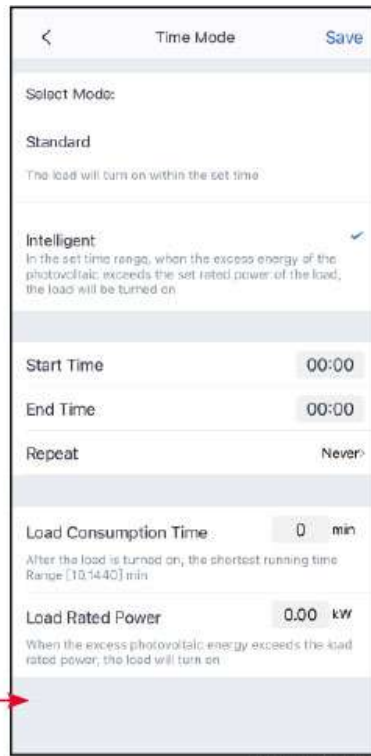

SLG00CON0081

No.	Parameters	Description
1	Standard	The loads will be powered within the setting time period.
2	Intelligent	Once the excess energy of the photovoltaic exceeds the load nominal power within the time period, the loads will be powered.
3	Start Time	The time mode will be on between the Start Time and End Time.
4	End Time	
5	Repeat	The repeat days.
6	Load Consumption Time	The shortest load working time after the loads been powered. The time is set to prevent the loads be turned on and off frequently when the PV power fluctuates greatly. Only for Intelligent mode.
7	Load Rated Power	The loads will be powered when the excess energy of the photovoltaic exceeds the nominal power of load. Only for Intelligent mode.

- SOC Mode: the inverter has integrated dry contact controlling port, which can control whether the load is powered or not by contactor. In off-grid mode, the load

connected to the port will not be powered if the BACKUP overload is detected or the battery SOC value is lower than the Off-grid battery protection value. Set Off-grid Battery Protection Value based on actual needs.



SLG00CON0082

7.2.11.2 Setting the Generator Parameters

NOTICE

- When the inverter supports the generator control function, the generator can be controlled through the SolarGo App.
- For ET40-50kW series inverters, the generator can be connected and controlled only when the inverter is used with STS.

Step 1 : Tap **Home > Settings > Port Connection** to set the parameters.

Step 2: Select Generator Connection or Load Connection based on actual needs.

Step 3 : When setting the generator control function, select the generator type according to the actual access situation. Currently supported:**Not Installed, Manual Control Of Generator** or **Automatic Control Generator**. And set the parameters according to the selected generator type.

- Not Installed: If no generator is connected in the system, select Not Installed.
- Manual Control Of Generator(Doesn't Support Dry Node Connection): Start or stop the generator manually. The inverter cannot control the generator when Manual

Control Of Generator(Doesn't Support Dry Node Connection) is selected.

- Automatic control generator (Supports dry node connection): If the generator has dry contact port and is connected to the inverter, set the generator control mode to Switch Control Mode or Automatic Control Mode based on actual needs.
 - Switch Control Mode: The generator will start working when the Generator Dry Node Switch is on, and stop automatically after reaching Run Time.
 - Automatic Control Mode: The generator will work during Run Time, but stop working during Prohibited Working Hours.

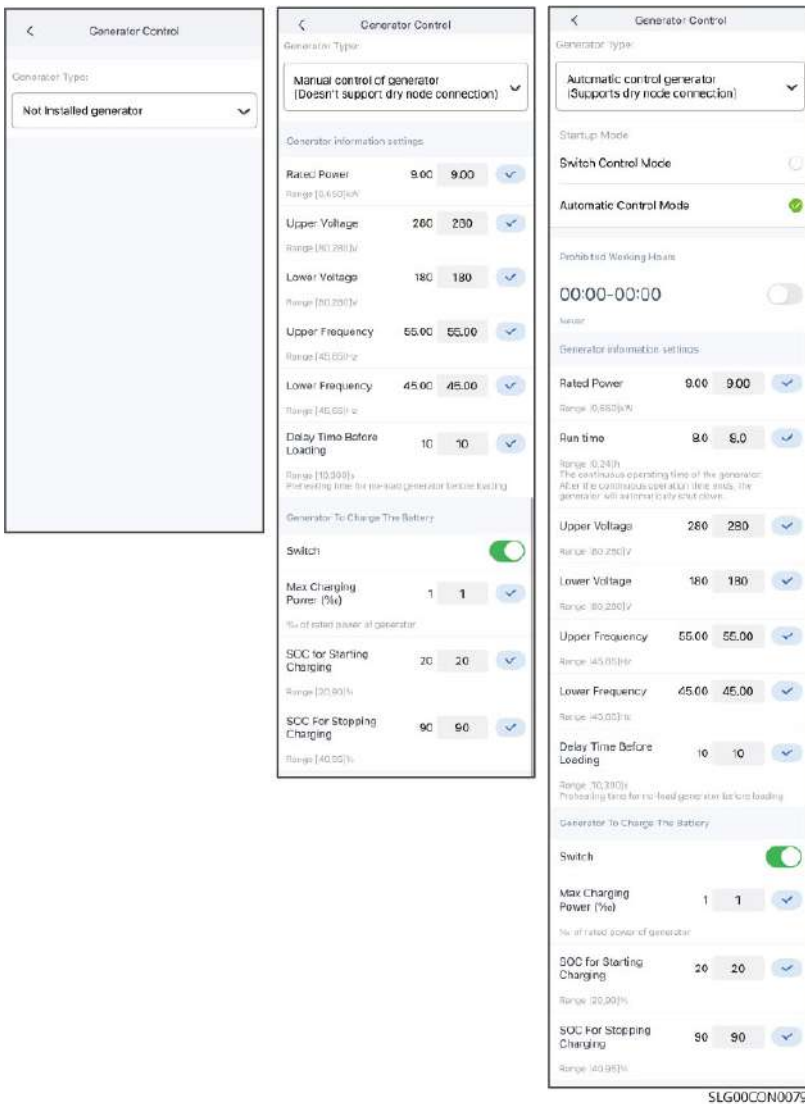

No.	Parameters	Description
1	Startup Mode	Switch Control Mode/Automatic Control Mode
Switch Control Mode		

No.	Parameters	Description
2	Generator Dry Node Switch	Only for Switch Control Mode.
3	Run Time	Set the generator's continuous runtime, after which the generator will be turned off.
Automatic Control Mode		
4	Prohibited Working Hours	Set the time period during which the generator cannot work.
5	Run Time	Set the generator's continuous runtime, after which the generator will be turned off. If the generator start-up operation time includes prohibited working time, the generator will stop running during this time period; after the prohibited working time, the generator will restart running and timing.

No.	Parameters	Description
Generator Information Settings		
1	Rated Power	Set the rated power of the generator.
2	Run Time	Set the continuous running time of the generator. The generator will be shut down after the continuous running time ends.
3	Upper Voltage	Set the operation voltage range of the generator.
4	Lower Voltage	
5	Frequency Cap	Set the operation frequency range of the generator.
6	Lower Frequency	
7	Preheating time	Set the generator no-load preheating time.
Parameter settings for generator charging batteries		
8	Switch	Select whether to use the generator to generate electricity to charge the battery.

No.	Parameters	Description
9	Max.charging power (%)	The charging power when the generator generates electricity to charge the battery.
10	Start charging SOC	When the battery SOC is lower than this value, the generator generates electricity to charge the battery.
11	Stop charging SOC	When the battery SOC is higher than this value, stop charging the battery.

7.2.11.3 Setting Microgrid Parameters

NOTICE

When the inverter supports microgrid function, you can set microgrid parameters through SolarGo App.

Step 1 : Tap **Home > Settings > Port Connection** to set the parameters.

Step 2 : According to the actual interface prompts, enter the microgrid control interface and set the microgrid parameters according to actual needs.



SLG00CON0078

No.	Parameters	Description
1	Maximum SOC for Charging	Set the upper limit of charging SOC, and stop charging when the upper limit is reached.
2	Manual wake-up	<ul style="list-style-type: none"> When the grid fails, if the battery power is low, the energy storage inverter cannot be supported to work off the grid. Click this button to force the energy storage inverter to output voltage to the grid-connected inverter, thereby starting the grid-connected inverter. Single effect.

No.	Parameters	Description
3	Automatic wake-up	<ul style="list-style-type: none"> When the grid fails, if the battery power is low, the energy storage inverter cannot be supported to work off the grid. After enabling this function, the system will force the energy storage inverter to output voltage to the grid-connected inverter at a fixed time, thereby starting the grid-connected inverter. Multiple effect.
4	Grid Import Power Limit Offset	Set the adjustable range of the maximum power that the device can actually buy from the grid.

7.2.12 Equipment Maintenance

7.2.12.1 Checking Firmware Information/Upgrading Firmware Version

Upgrade the DSP version, ARM version, BMS version, AFCI version, or STS version of the inverter, or firmware version of the communication module. Some devices do not support upgrading the firmware version through SolarGo app.

NOTICE

If the Firmware Upgrade dialog box pops up once logging into the app, click Firmware Upgrade to directly go to the firmware information page.

7.2.12.1.1 Regular Upgrade

NOTICE

- When there is a red dot on the right side of the firmware information, please click to view the firmware update information.
- During the upgrade process, please ensure that the network is stable and the device is connected to SolarGo, otherwise the upgrade may fail.

Step 1 : Tap **Home > Settings > Firmware Information** to check the firmware version. If the firmware upgrade dialog box pops up, tap **Firmware Upgrade** and turn to the upgrade interface.

Step 2 : (Optional) Tap **Check For Update** to confirm whether the latest firmware version is available for updating.

Step 3: Tap **Firmware Upgrade** to enter the firmware upgrade interface.

Step 4 : (Optional) Tap **Learn More** to view firmware-related information, such as the current version, the latest version, firmware update records, etc.

Step 5 : Tap **Upgrade** and complete the upgrade according to the prompts on the interface.

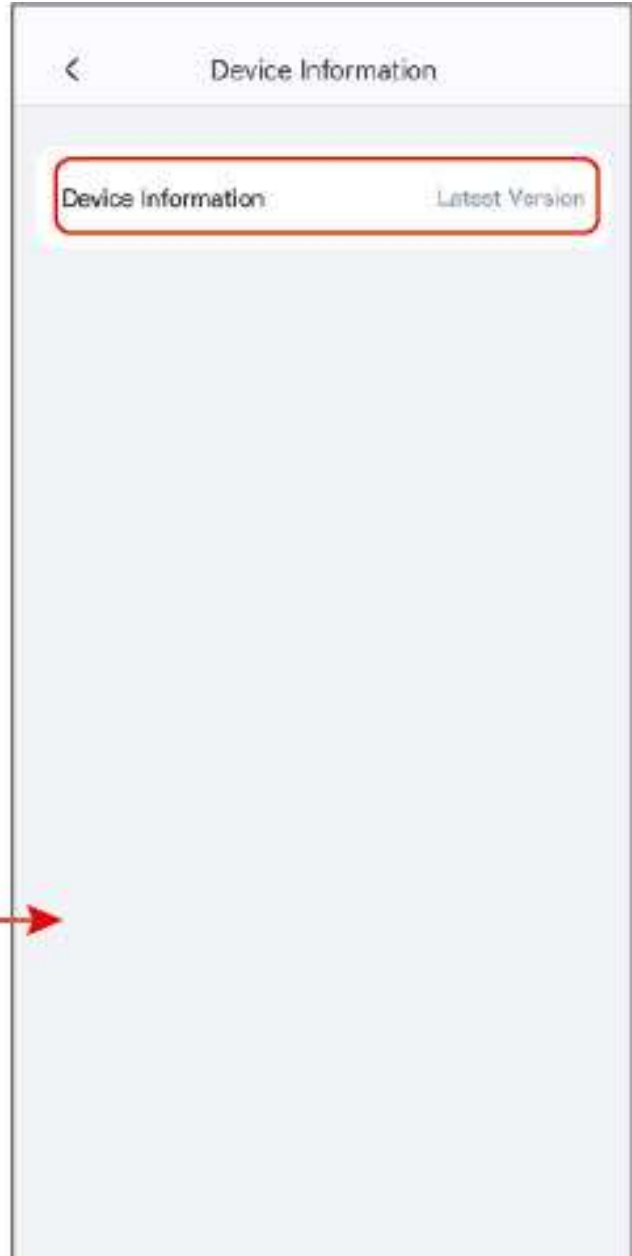

SLG00CON0087

7.2.12.1.2 One-click Upgrade

NOTICE

- When there is a red dot on the right side of the firmware information, please click to view the firmware update information.
- During the upgrade process, please ensure that the network is stable and the device is connected to SolarGo, otherwise the upgrade may fail.

Step 1 : Tap **Home** > **Settings** > **Firmware Information**. Tap **Firmware Information** as prompted to enter the firmware upgrade page.

Step 2 : Tap **Upgrade** and follow the prompts to complete the upgrading. If you only need to upgrade a specific firmware version, tap **Learn More** to check the firmware related information and tap **Firmware Upgrade** below the firmware version you want to upgrade, and follow the on-screen prompts to complete the operation.

Step 3 : Tap **Learn More** to view all current firmware version information.

Step 4: (Optional) Tap ,to view the version upgrade record.

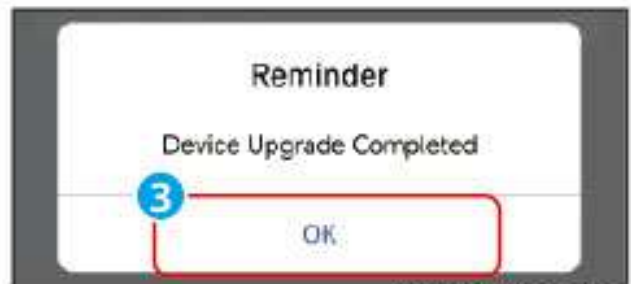
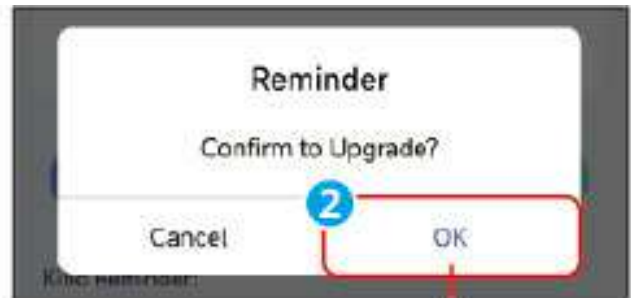
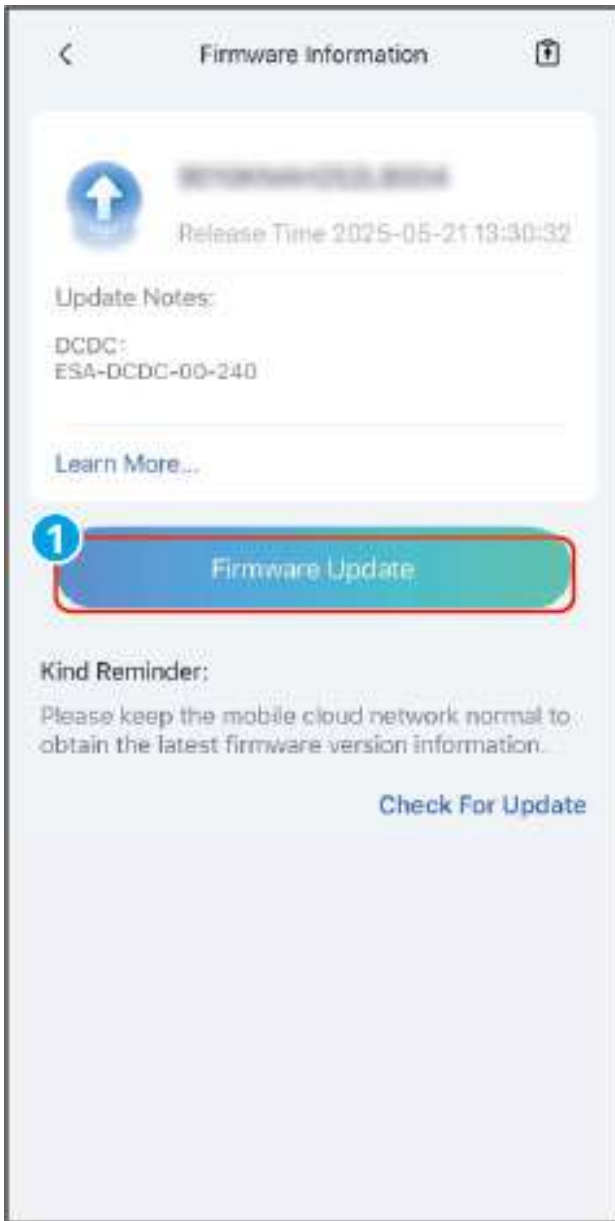

SLG00CON0127

7.2.12.1.3 Automatic Upgrade

NOTICE

- When using WiFi/LAN Kit-20 or WiFi Kit-20 module communication and the module firmware version is V2.0.1 or above, the device automatic upgrade function can be enabled.
- After the device automatic upgrade function is enabled, if the module version is updated and the device has been connected to the network, the corresponding firmware version can be automatically upgraded.

Step 1 : Tap **Home > Settings > Firmware Information.**

Step 2 : Enable or disable the automatic device upgrade function according to actual needs.

7.2.12.1.4 Checking Firmware Information

Step 1: Tap **Parameters > Firmware Version** to check the version information.



SLG00CON0191

7.2.12.2 Change the Login Password

NOTICE

The login password can be changed. Keep the changed password in mind after changing it. Contact the after-sales service if you forget the password.

Step 1 : Tap **Home > Settings > Change Login Password** to change the password.

Step 2 : Change the password based on actual needs.

Change Login Password [Save](#)

Please enter the new password

Please enter new password again

Note: 8-16 characters, need a combination of numbers and uppercase or lowercase letters (0-9, a-z, A-Z)

SLG00CON0088

8 System Debugging and Power Station Monitoring

8.1 Setting Inverter Parameters via App

SEMS+ App is a software for remote power station monitoring or local device debugging. It supports installers or owners:

- Remotely monitor the operation of the power station and set the operating parameters of the station and devices.
- Locally connect to devices, view device operation status, and set device parameters.

For detailed functions, please refer to the [SEMS+ App User Manual](#). The user manual can be obtained from the official website or by scanning the QR code below.



SEMS+ App User Manual

8.1.1 Download and Install SEMS+ App

Mobile Phone Requirements:

- Mobile operating system requirements: Android 7.0 and above, iOS 15.1 and above.
- The phone supports a web browser and connects to the Internet.
- The phone supports WLAN/Bluetooth functionality.

Download Methods:

Method 1:

Search for SEMS+ in Google Play, App Store, Huawei, Honor, Xiaomi, OPPO, vivo app stores to download and install.



Method 2:

Scan the QR code below to download and install.

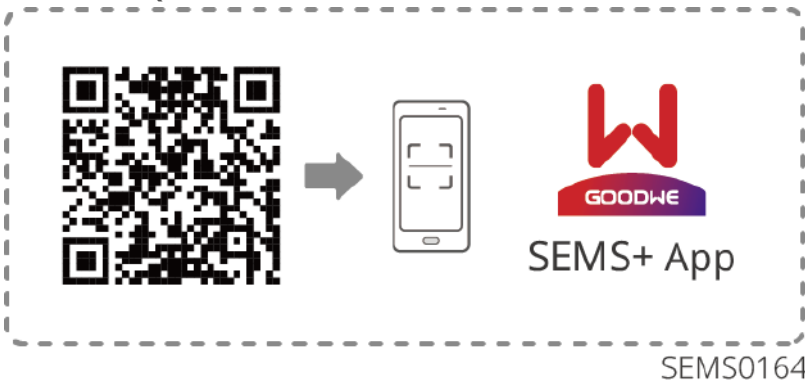

8.2 Monitoring Power Plants via SEMS+ WEB

SEMS+ WEB is a monitoring platform that communicates via WiFi or LAN. The following are the common functions of SEMS+ WEB:

1. Manage organizational or user information, etc.
2. Add and monitor power plant information, etc.
3. Maintain equipment.

For detailed functions, please refer to the [SEMS+ WEB User Manual](#).



SEMS+ WEB User Manual

9 Maintenance

9.1 Power OFF the System

DANGER

- When performing operation and maintenance on equipment within the system, please power down the system. Operating equipment while energized may cause equipment damage or electric shock hazard.
- After the equipment is powered off, internal components require a certain amount of time to discharge. Please wait according to the label's time requirement until the equipment is completely discharged.
- Restarting the battery should be performed using the air switch power-on method.
- When shutting down the battery system, please strictly adhere to the battery system power-down requirements to prevent damage to the battery system.
- When there are multiple batteries in the system, powering down any one battery will power down all batteries.

NOTICE

- The circuit breakers between the inverter and the battery, and between battery systems, must be installed in accordance with local laws and regulations.
- To ensure effective protection of the battery system, the cover plate of the battery system switch should remain closed, and the protective cover should automatically close after being opened. If the battery system switch is not used for a long time, it must be secured with screws.

Power OFF Procedure

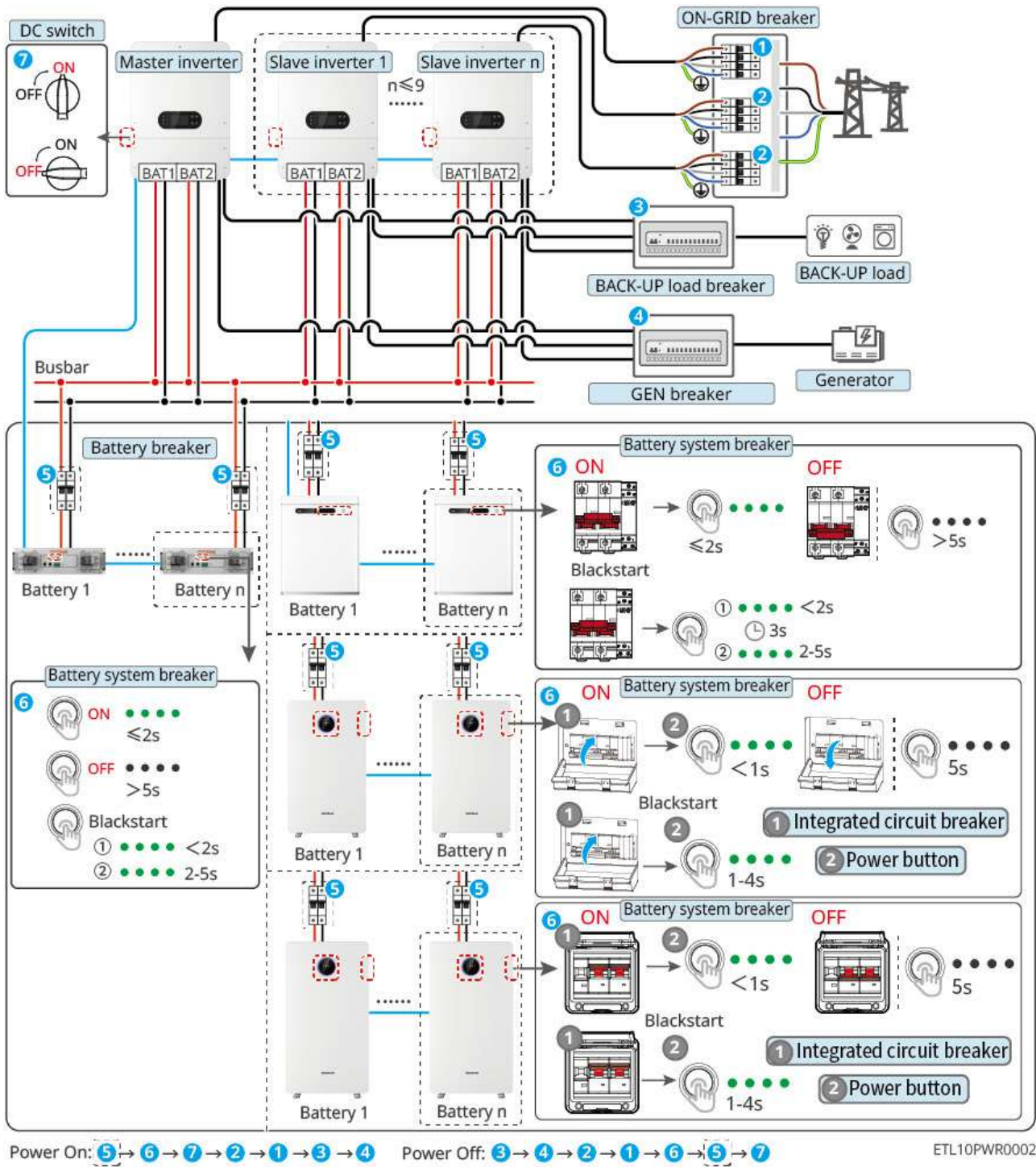

1. Turn OFF the BACK-UP circuit breaker.
2. (Optional) Turn OFF the GEN circuit breaker.
3. Turn OFF the main inverter ON-GRID circuit breaker.
4. (Optional) Turn OFF the slave inverter ON-GRID circuit breaker.
5. Turn OFF the battery system switch.

- a. LX A5.0-30: Turn OFF the battery system switch.
 - b. LX U5.0-30, GW14.3-BAT-LV-G10, GW16.1-BAT-LV-G10: Close the battery system integrated circuit breaker or press and hold the battery system button for ≥ 5 seconds, and the battery system integrated circuit breaker will automatically turn OFF.
6. (Select according to local regulations) Turn OFF the switch between the inverter and the battery.
 7. Turn OFF the DC switch of the inverter.

9.2 Removing the Equipment



- Ensure the device is powered off.
- When operating the device, please wear personal protective equipment.
- When removing wiring terminals, use standard disassembly tools to avoid damaging the terminals or device.
- Unless otherwise specified, the device disassembly method is the reverse order of the installation method, and this document will not elaborate further.

1. Power down the system.
2. Use labels to mark the cable types for the cables connected in the system.
3. Disconnect the connection cables for the inverter, battery, and smart meter in the system, such as: DC cables, AC cables, communication cables, PE cables.
4. Remove devices such as the smart communication device, inverter, battery, and smart meter.
5. Store the devices properly. If they will be put into use later, ensure that the storage conditions meet the requirements.

9.3 Disposing of the Equipment

When the equipment can no longer be used and needs to be disposed of, please dispose of the equipment according to the electrical waste disposal regulations of the country/region where the equipment is located. Do not dispose of the equipment as household waste.

9.4 Routine Maintenance

WARNING

- If any issues are found that may affect the battery or energy storage inverter system, contact after-sales personnel. Disassembly by unauthorized persons is prohibited.
- If exposed copper wires are found inside the conductive wires, do not touch them. High voltage hazard. Contact after-sales personnel. Disassembly by unauthorized persons is prohibited.
- In case of other emergencies, contact after-sales personnel immediately. Operate under the guidance of after-sales personnel or wait for on-site operation by after-sales personnel.

Maintenance Item	Maintenance Method	Maintenance Cycle	Maintenance Purpose
System Cleaning	Check the heat sink, fan, and air inlet/outlet for foreign objects or dust. Check if the installation space meets requirements and if there is any debris accumulated around the equipment.	Once every six months	Prevent cooling failures.
System Installation	Check if the equipment installation is secure and if fastening screws are loose. Check the equipment exterior for damage or deformation.	Once every six months to once a year	Confirm equipment installation stability.
Electrical Connections	Check electrical connections for looseness, inspect cable exteriors for damage or exposed copper.	Once every six months to once a year	Confirm electrical connection reliability.

Maintenance Item	Maintenance Method	Maintenance Cycle	Maintenance Purpose
Sealing	Check if the sealing of equipment cable entry holes meets requirements. If gaps are too large or unsealed, re-seal them.	Once a year	Confirm the machine is sealed and its waterproof performance is intact.
Battery Maintenance	If the battery has been unused or not fully charged for an extended period, it is recommended to charge it regularly.	Once every 15 days	Protect battery service life.

9.5 fault

9.5.1 Viewing Fault/Alarms Information

All fault and alarm details of the energy storage system are displayed in [SolarGo APP], [SEMS+ App], and [SEMS+ WEB]. If your product is abnormal and you do not see relevant fault information in [SolarGo APP], [SEMS+ App], and [SEMS+ WEB], please contact the after-sales service center.

- SolarGo APP

Through [Home] > [Parameters] > [Alarms], view the alarm information of the energy storage system.

- SEMS App

1. Open the SEMS App, log in with any account.
2. Through [Power Station] > [Alarms], you can view all fault information of the power station.
3. Click on the specific fault name to view the time when the fault occurred, possible causes, and solutions.

SEMS+ WEB

- Open SEMS+ WEB, log in with any account.
- On the power station details interface, click [Alarms] to view all alarm information

of the current power station.

9.5.2 Fault Information and Troubleshooting

Please troubleshoot according to the following methods. If the troubleshooting methods cannot help you, please contact the after-sales service center.

When contacting the after-sales service center, please collect the following information to facilitate a quick resolution.

1. Product information, such as: serial number, software version, device installation time, fault occurrence time, fault frequency, etc.
2. Device installation environment, such as: weather conditions, whether components are blocked, have shadows, etc. Providing photos, videos, and other files for the recommended installation environment can assist in problem analysis.
3. Grid conditions.

9.5.2.1 System Malfunction

If the system experiences a problem not listed, or following the instructions does not resolve the issue or abnormality, immediately stop operating the system and contact your dealer at once.

No.	fault	Resolution Measures
1	Unable to search for the Smart Communication Stick wireless signal	<ol style="list-style-type: none">1. Please ensure no other devices are connected to the Smart Communication Stick wireless signal.2. Please ensure the App is upgraded to the latest version.3. Ensure the Smart Communication Stick is powered normally, and the blue signal light is blinking or constantly on.4. Ensure the smart device is within the communication range of the Smart Communication Stick.5. Refresh the App device list again.6. Restart the inverter.

No.	fault	Resolution Measures
2	Unable to connect to the Smart Communication Stick wireless signal	<ol style="list-style-type: none"> 1. Please ensure no other devices are connected to the Smart Communication Stick wireless signal. 2. Restart the inverter or communication stick, and try to connect to the Smart Communication Stick wireless signal again. 3. Ensure Bluetooth encryption pairing is successful.
3	Unable to find the router SSID	<ol style="list-style-type: none"> 1. Place the router closer to the Smart Communication Stick, or add a WiFi repeater to enhance the WiFi signal. 2. Reduce the number of devices connected to the router.
4	After all configurations are completed, the Smart Communication Stick fails to connect to the router	<ol style="list-style-type: none"> 1. Restart the inverter. 2. Check if the network name, encryption method, and password in the WiFi configuration are the same as those of the router. 3. Restart the router. 4. Place the router closer to the Smart Communication Stick, or add a WiFi repeater to enhance the WiFi signal.
5	After all configurations are completed, the Smart Communication Stick fails to connect to the server	Restart the router and inverter.

9.5.2.2 Inverter Fault

9.5.2.2.1 Troubleshooting (Fault Codes F01-F40)

Fault Code	Fault Name	Fault Cause	Troubleshooting Suggestions
F01	Grid Power Outage	<ol style="list-style-type: none"> 1. Grid power outage. 2. AC line or AC switch is disconnected. 	<ol style="list-style-type: none"> 1. The alarm will disappear automatically after grid power is restored. 2. Check if the AC line or AC switch is disconnected.
F02	Grid Overvoltage Protection	<p>Grid voltage exceeds the allowable range, or the high-voltage duration exceeds the HVRT setting value.</p>	<ol style="list-style-type: none"> 1. If it occurs occasionally, it may be a short-term grid anomaly. The inverter will resume normal operation after detecting a normal grid, requiring no manual intervention. 2. If it occurs frequently, check if the grid voltage is within the allowable range. If not, contact the local power operator. If it is, you also need to modify the grid overvoltage protection point after obtaining consent from the local power operator. 3. If it cannot be restored for a long time, check if the AC side circuit breaker and output cables are properly connected.

Fault Code	Fault Name	Fault Cause	Troubleshooting Suggestions
F03	Grid Undervoltage Protection	Grid voltage is below the allowable range, or the low-voltage duration exceeds the LVRT setting value.	<ol style="list-style-type: none"> 1. If it occurs occasionally, it may be a short-term grid anomaly. The inverter will resume normal operation after detecting a normal grid, requiring no manual intervention. 2. If it occurs frequently, check if the grid voltage is within the allowable range. If not, contact the local power operator. If it is, you also need to modify the grid undervoltage protection point after obtaining consent from the local power operator. 3. If it cannot be restored for a long time, check if the AC side circuit breaker and output cables are properly connected.

Fault Code	Fault Name	Fault Cause	Troubleshooting Suggestions
F04	Grid Rapid Overvoltage Protection	Abnormal grid voltage detection or ultra-high voltage triggers the fault.	<p>1. If it occurs occasionally, it may be a short-term grid anomaly. The inverter will resume normal operation after detecting a normal grid, requiring no manual intervention.</p> <p>2. If it occurs frequently, check if the grid voltage is within the allowable range. If not, contact the local power operator. If it is, you also need to modify the grid undervoltage protection point after obtaining consent from the local power operator.</p> <p>3. If it cannot be restored for a long time, check if the AC side circuit breaker and output cables are properly connected.</p>
F05	10min Overvoltage Protection	The moving average of grid voltage within 10min exceeds the safety regulation specified range.	Check if the grid voltage has been operating at a high level for a long time. If it occurs frequently, check if the grid frequency is within the allowable range. If not, contact the local power operator. If it is, you also need to modify the grid 10min overvoltage protection point after obtaining consent from the local power operator.

Fault Code	Fault Name	Fault Cause	Troubleshooting Suggestions
F06	Grid Overfrequency	Grid anomaly: The actual grid frequency is higher than the local grid standard requirements.	<p>1. If it occurs occasionally, it may be a short-term grid anomaly. The inverter will resume normal operation after detecting a normal grid, requiring no manual intervention.</p> <p>2. If it occurs frequently, check if the grid frequency is within the allowable range. If not, contact the local power operator. If it is, you also need to modify the grid overfrequency protection point after obtaining consent from the local power operator.</p>
F07	Grid Underfrequency	Grid anomaly: The actual grid frequency is lower than the local grid standard requirements.	<p>1. If it occurs occasionally, it may be a short-term grid anomaly. The inverter will resume normal operation after detecting a normal grid, requiring no manual intervention.</p> <p>2. If it occurs frequently, check if the grid frequency is within the allowable range. If not, contact the local power operator. If it is, you also need to modify the grid overfrequency protection point after obtaining consent from the local power operator.</p>

Fault Code	Fault Name	Fault Cause	Troubleshooting Suggestions
F08	Grid Frequency Instability	Grid anomaly: The rate of change of the actual grid frequency does not comply with local grid standards.	<p>1. If it occurs occasionally, it may be a short-term grid anomaly. The inverter will resume normal operation after detecting a normal grid, requiring no manual intervention.</p> <p>2. If it occurs frequently, check if the grid frequency is within the allowable range. If not, contact the local power operator.</p>
F09	Anti-islanding Protection	The grid has been disconnected, but grid voltage is maintained due to the presence of loads. Grid connection is stopped according to safety protection requirements.	<p>1. If it occurs occasionally, it may be a short-term grid anomaly. The inverter will resume normal operation after detecting a normal grid, requiring no manual intervention.</p> <p>2. If it occurs frequently, check if the grid frequency is within the allowable range. If not, contact the local power operator.</p>
F10	LVRT Undervoltage Fault	Grid anomaly: The duration of abnormal grid voltage exceeds the time specified by the HVRT/LVRT.	<p>1. If it occurs occasionally, it may be a short-term grid anomaly. The inverter will resume normal operation after detecting a normal grid, requiring no manual intervention.</p> <p>2. If it occurs frequently, check if the grid voltage and frequency are within the allowable range and stable. If not, contact the local power operator.</p>

Fault Code	Fault Name	Fault Cause	Troubleshooting Suggestions
F11	HVRT Overvoltage	Grid anomaly: The duration of abnormal grid voltage exceeds the time specified by the HVRT/LVRT.	<p>1. If it occurs occasionally, it may be a short-term grid anomaly. The inverter will resume normal operation after detecting a normal grid, requiring no manual intervention.</p> <p>2. If it occurs frequently, check if the grid voltage and frequency are within the allowable range and stable. If not, contact the local power operator.</p>
F12	30mA GFCI Protection	The input-to-ground insulation impedance becomes low during inverter operation.	<p>1. If it occurs occasionally, it may be caused by occasional external line anomalies. It will resume normal operation after the fault is cleared, requiring no manual intervention.</p> <p>2. If it occurs frequently or cannot be restored for a long time, check if the PV string's impedance to ground is too low.</p>
F13	60mA GFCI Protection	The input-to-ground insulation impedance becomes low during inverter operation.	<p>1. If it occurs occasionally, it may be caused by occasional external line anomalies. It will resume normal operation after the fault is cleared, requiring no manual intervention.</p> <p>2. If it occurs frequently or cannot be restored for a long time, check if the PV string's impedance to ground is too low.</p>

Fault Code	Fault Name	Fault Cause	Troubleshooting Suggestions
F14	150mA GFCI Protection	The input-to-ground insulation impedance becomes low during inverter operation.	<p>1. If it occurs occasionally, it may be caused by occasional external line anomalies. It will resume normal operation after the fault is cleared, requiring no manual intervention.</p> <p>2. If it occurs frequently or cannot be restored for a long time, check if the PV string's impedance to ground is too low.</p>
F15	GFCI Gradual Change Protection	The input-to-ground insulation impedance becomes low during inverter operation.	<p>1. If it occurs occasionally, it may be caused by occasional external line anomalies. It will resume normal operation after the fault is cleared, requiring no manual intervention.</p> <p>2. If it occurs frequently or cannot be restored for a long time, check if the PV string's impedance to ground is too low.</p>
F16	DCI Level 1 Protection	The DC component of the inverter output current is higher than the safety regulation or the machine's default allowable range.	<p>1. If it is caused by an external fault, the inverter will automatically resume normal operation after the fault disappears, requiring no manual intervention.</p> <p>2. If this alarm occurs frequently, affecting the normal power generation of the power station, contact the distributor or after-sales service center.</p>

Fault Code	Fault Name	Fault Cause	Troubleshooting Suggestions
F17	DCI Level 2 Protection	The DC component of the inverter output current is higher than the safety regulation or the machine's default allowable range.	<ol style="list-style-type: none"> 1. If it is caused by an external fault, the inverter will automatically resume normal operation after the fault disappears, requiring no manual intervention. 2. If this alarm occurs frequently, affecting the normal power generation of the power station, contact the distributor or after-sales service center.

Fault Code	Fault Name	Fault Cause	Troubleshooting Suggestions
F18	Low Insulation Resistance	<ol style="list-style-type: none"> 1. PV string shorted to protective earth. 2. The PV string installation environment is long-term humid and the line has poor insulation to ground. 3. Battery port line has low impedance to ground. 	<ol style="list-style-type: none"> 1. Check the impedance of the PV string/battery port to protective earth. A value greater than 80kΩ is normal. If the checked value is less than 80kΩ, locate and rectify the short-circuit point. 2. Check if the inverter's protective earth wire is correctly connected. 3. If it is confirmed that the impedance is indeed lower than the default value in rainy/overcast environments, reset the inverter's "Insulation Impedance Protection Point" via the App. <p>For inverters in the Australian and New Zealand markets, the following additional alarm methods apply when an insulation impedance fault occurs:</p> <ol style="list-style-type: none"> 1. The inverter is equipped with a buzzer. When a fault occurs, the buzzer sounds continuously for 1 minute; if the fault is not resolved, the buzzer sounds again every 30 minutes. 2. If the inverter is added to the monitoring platform and alarm notification methods are set, alarm information can be sent to the customer via email.

Fault Code	Fault Name	Fault Cause	Troubleshooting Suggestions
F19	Grounding Abnormal	1. The inverter's protective earth wire is not connected. 2. When the PV string output is grounded, the inverter output side is not connected to an isolation transformer.	1. Confirm if the inverter's protective earth wire is not properly connected. 2. In scenarios where the PV string output is grounded, confirm if the inverter output side is connected to an isolation transformer.
F20	Hardware Anti-backfeed Protection	Load abnormal fluctuation	1. If it is caused by an external fault, the inverter will automatically resume normal operation after the fault disappears, requiring no manual intervention. 2. If this alarm occurs frequently, affecting the normal power generation of the power station, contact the distributor or after-sales service center.

Fault Code	Fault Name	Fault Cause	Troubleshooting Suggestions
F21	Internal Comm Loss	Sub DSP1 communication timeout - Main DSP, Sub DSP2 communication timeout - Main DSP, Sub DSP2 communication timeout - Sub DSP1, Main DSP communication timeout - Sub DSP1, Main DSP communication timeout - Sub DSP2 or Sub DSP1 communication timeout - Sub DSP2: 1. Chip not powered on 2. Chip program version error	Disconnect the AC output side switch and DC input side switch, wait for 5 minutes, then close the AC output side switch and DC input side switch. If the fault persists, contact the distributor or after-sales service center.

Fault Code	Fault Name	Fault Cause	Troubleshooting Suggestions
		Main DSP can module error, Sub DSP1 can module error or Sub DSP2 can module error: 1. Frame format error 2. Parity check error 3. can bus offline 4. Hardware CRC check error 5. Control bit is receive (transmit) during transmission (reception) 6. Transmission to an unauthorized unit	
F22	Generator Waveform Detection Fault	1. This fault will be displayed continuously when the generator is not connected; 2. When the generator is operating, failure to meet generator safety regulations will trigger this fault.	
F23	Generator Abnormal Connection		
F24	Generator Voltage Low		
F25	Generator Voltage High		
F26	Generator Frequency Low		

Fault Code	Fault Name	Fault Cause	Troubleshooting Suggestions
F27	Generator Frequency High		<p>1. Ignore this fault when the generator is not connected;</p> <p>2. When this fault occurs due to a generator fault, it is normal. Wait for a period after the generator recovers, and the fault will clear automatically;</p> <p>3. This fault does not affect the normal operation of off-grid mode.</p> <p>4. When both the generator and grid are connected and meet safety requirements, the grid has priority for grid connection, and the system will operate in grid-connected status.</p>
F28	Parallel I/O Self-check Abnormal	Parallel communication cable is not securely connected or parallel IO chip is damaged	Check if the parallel communication cable is securely connected, then check if the IO chip is damaged. If yes, replace the IO chip.
F29	Parallel Grid Line Reversed	Some machines' grid lines are connected in reverse with others	Reconnect the grid lines correctly.
F30	AC HCT check Abnormal	AC sensor has sampling abnormality	Disconnect the AC output side switch and DC input side switch, wait for 5 minutes, then close the AC output side switch and DC input side switch. If the fault persists, contact the distributor or after-sales service center.

Fault Code	Fault Name	Fault Cause	Troubleshooting Suggestions
F31	GFCI HCT Check Abnormal	Leakage current sensor has sampling abnormality	Disconnect the AC output side switch and DC input side switch, wait for 5 minutes, then close the AC output side switch and DC input side switch. If the fault persists, contact the distributor or after-sales service center.
F32	Inverter Internal Failure	Inverter has a fault	Disconnect the AC output side switch and DC input side switch, wait for 5 minutes, then close the AC output side switch and DC input side switch. If the fault persists, contact the distributor or after-sales service center.
F33	Flash Read/Write Error	Possible causes: flash content changed; flash lifespan exhausted;	<ol style="list-style-type: none"> 1. Upgrade to the latest program version. 2. Contact the distributor or after-sales service center.
F34	AFCI Check Failure	During the arc self-check process, the arc detection module did not detect an arc fault as expected.	Disconnect the AC output side switch and DC input side switch, wait for 5 minutes, then close the AC output side switch and DC input side switch. If the fault persists, contact the distributor or after-sales service center.

Fault Code	Fault Name	Fault Cause	Troubleshooting Suggestions
F35	Cabinet Overtemperature	<p>Cabinet temperature is too high, possible causes:</p> <ol style="list-style-type: none"> 1. Inverter installation location is not ventilated. 2. Ambient temperature is too high. 3. Internal fan operation is abnormal. 	<ol style="list-style-type: none"> 1. Check if the ventilation at the inverter installation location is good and if the ambient temperature exceeds the maximum allowable ambient temperature range. 2. If ventilation is poor or ambient temperature is too high, improve its ventilation and heat dissipation conditions. 3. If ventilation and ambient temperature are both normal, contact the distributor or after-sales service center.

Fault Code	Fault Name	Fault Cause	Troubleshooting Suggestions
F36	Bus Overvoltage	BUS overvoltage, possible causes: 1. PV voltage is too high; 2. Inverter BUS voltage sampling is abnormal; 3. The isolation effect of the dual-split transformer at the inverter rear end is poor, causing mutual influence when two inverters are connected in parallel, with one inverter reporting DC overvoltage during grid connection;	Disconnect the AC output side switch and DC input side switch, wait for 5 minutes, then close the AC output side switch and DC input side switch. If the fault persists, contact the distributor or after-sales service center.

Fault Code	Fault Name	Fault Cause	Troubleshooting Suggestions
F37	PV Input Overvoltage	PV input voltage is too high, possible cause: PV array configuration error, too many PV panels connected in series per string, causing the string's open-circuit voltage to be higher than the inverter's maximum operating voltage.	Check the series configuration of the corresponding PV array string to ensure the string's open-circuit voltage is not higher than the inverter's maximum operating voltage. After the PV array is correctly configured, the inverter alarm will disappear automatically.
F38	PV Continuous Hardware Overcurrent	1. Module configuration unreasonable. 2. Hardware damaged.	Disconnect the AC output side switch and DC input side switch, wait for 5 minutes, then close the AC output side switch and DC input side switch. If the fault persists, contact the distributor or after-sales service center.
F39	PV Continuous Software Overcurrent	1. Module configuration unreasonable. 2. Hardware damaged.	Disconnect the AC output side switch and DC input side switch, wait for 5 minutes, then close the AC output side switch and DC input side switch. If the fault persists, contact the distributor or after-sales service center.

Fault Code	Fault Name	Fault Cause	Troubleshooting Suggestions
F40, F98	String Reverse Connection (String 1-n) n: Determined based on the actual number of inverter strings.	PV string reverse connection	Check if the string is reversely connected.

9.5.2.2.2 Troubleshooting (Fault Codes F41-F80)

Fault Code	Fault Name	Fault Cause	Troubleshooting Recommendation
F41	Generator Port Overload	<ol style="list-style-type: none"> 1. Off-grid side output exceeds specification requirements. 2. Off-grid side short circuit. 3. Off-grid terminal voltage is too low. 4. When used as a heavy load port, the heavy load exceeds specification requirements. 	<ol style="list-style-type: none"> 1. Confirm the off-grid side output voltage, current, power and other data to identify the cause of the problem.

Fault Code	Fault Name	Fault Cause	Troubleshooting Recommendation
F42	DC Arcing Failure (String 1-n) n: Determined by the actual number of inverter strings.	1. Loose DC side connection terminals. 2. Poor contact at DC side connection terminals. 3. Damaged DC cable cores causing poor contact.	1. After the unit reconnects to the grid, check if the voltage and current of each string abnormally decrease or become zero. 2. Check if the DC side terminals are securely connected.
F43	Grid Waveform Abnormal	Utility grid abnormality: Abnormal grid voltage detection triggers the fault.	1. If it occurs occasionally, it may be due to a short-term grid abnormality. The inverter will resume normal operation after detecting a normal grid, requiring no manual intervention. 2. If it occurs frequently, please check if the grid voltage and frequency are within the allowable range and stable. If not, please contact the local power operator.
F44	Grid Phase Loss	Utility grid abnormality: Single-phase voltage dip on the grid.	1. If it occurs occasionally, it may be due to a short-term grid abnormality. The inverter will resume normal operation after detecting a normal grid, requiring no manual intervention. 2. If it occurs frequently, please check if the grid voltage and frequency are within the allowable range and stable. If not, please contact the local power operator.

Fault Code	Fault Name	Fault Cause	Troubleshooting Recommendation
F45	Grid Voltage Imbalance	Excessive difference in grid phase voltages.	<p>1. If it occurs occasionally, it may be due to a short-term grid abnormality. The inverter will resume normal operation after detecting a normal grid, requiring no manual intervention.</p> <p>2. If it occurs frequently, please check if the grid voltage and frequency are within the allowable range and stable. If not, please contact the local power operator.</p>
F46	Grid Phase Sequence Failure	Inverter and grid wiring abnormality: Wiring is not in positive sequence.	<p>1. Check if the inverter and grid wiring are in positive sequence. The fault will automatically disappear after correct wiring (e.g., swapping any two live wires).</p> <p>2. If the fault persists despite correct wiring, please contact the dealer or after-sales service center.</p>
F47	Grid Rapid Shutdown Protection	Quickly shuts down output after detecting a grid power outage condition.	The fault automatically disappears after grid power supply is restored.
F48	Grid Neutral Wire Loss (Split-phase Grid)	Loss of neutral wire in a split-phase grid.	<p>1. The alarm automatically disappears after grid power supply is restored.</p> <p>2. Check if the AC line or AC switch is disconnected.</p>
F49	L-PE Short Circuit	Low impedance or short circuit between output phase line and PE.	Measure the impedance between the output phase line and PE, locate the position with low impedance and repair it.

Fault Code	Fault Name	Fault Cause	Troubleshooting Recommendation
F50	DCV Level 1 Protection	Abnormal load fluctuation.	<p>1. If it is caused by an external fault, the inverter will automatically resume normal operation after the fault disappears, requiring no manual intervention.</p> <p>2. If this alarm occurs frequently, affecting normal power generation of the plant, please contact the dealer or after-sales service center.</p>
F51	DCV Level 2 Protection	Abnormal load fluctuation.	
F52	Leakage Current (GFCI) Multiple Fault Shutdown	North American safety regulations require manual reset or waiting 24h for recovery after multiple faults, no automatic recovery.	Please check if the PV string-to-ground impedance is too low.
F53	DC Arcing (AFCI) Multiple Fault Shutdown	North American safety regulations require manual reset or waiting 24h for recovery after multiple faults, no automatic recovery.	<p>1. After the unit reconnects to the grid, check if the voltage and current of each string abnormally decrease or become zero.</p> <p>2. Check if the DC side terminals are securely connected.</p>
F54	External Communication Link Failure	External device communication loss for the inverter. Possible causes: peripheral power issue, communication protocol mismatch, corresponding peripheral not configured, etc.	Determine based on the actual model and enabled detection bits. Peripherals not supported by certain models will not be detected.

Fault Code	Fault Name	Fault Cause	Troubleshooting Recommendation
F55	Back-up Port Overload Fault	Prevents the inverter from continuously outputting overload.	Turn off some off-grid loads to reduce the inverter's off-grid output power.
F56	Back-up Port Overvoltage Fault	Prevents inverter output overvoltage from damaging loads.	<ol style="list-style-type: none"> 1. If it occurs occasionally, it may be caused by load switching and requires no manual intervention. 2. If it occurs frequently, please contact the dealer or after-sales service center.
F57	External Box Fault	Waiting too long for Box relay switching during grid-to-off-grid transition.	<ol style="list-style-type: none"> 1. Check if the Box is working normally. 2. Check if the Box communication wiring is correct.
F58	CT Loss Fault	CT connection wire disconnected (Japanese safety regulation requirement).	Check if the CT wiring is correct.
F59	Parallel CAN Communication Abnormality	Parallel communication cable not securely connected or some units are offline.	Check if all units are powered on and if the parallel communication cables are securely connected.
F60	Parallel Back-up Connection Reversed	Backup wiring of some units is reversed with others.	Reconnect the backup wiring.
F61	Inverter Soft Start Failure	Inverter soft start failure during off-grid cold start.	Check if the inverter module is damaged.

Fault Code	Fault Name	Fault Cause	Troubleshooting Recommendation
F62	AC HCT Failure	HCT sensor abnormality exists.	Disconnect the AC output side switch and DC input side switch, wait 5 minutes, then close the AC output side switch and DC input side switch. If the fault persists, please contact the dealer or after-sales service center.
F63	GFCI HCT Failure	Leakage current sensor abnormality exists.	Disconnect the AC output side switch and DC input side switch, wait 5 minutes, then close the AC output side switch and DC input side switch. If the fault persists, please contact the dealer or after-sales service center.
F64	Inverter Internal Failure	Inverter fault exists.	Disconnect the AC output side switch and DC input side switch, wait 5 minutes, then close the AC output side switch and DC input side switch. If the fault persists, please contact the dealer or after-sales service center.
F65	AC Terminal Overtemperature	AC terminal temperature is too high. Possible causes: 1. Inverter installation location lacks ventilation. 2. Ambient temperature is too high. 3. Internal fan operation is abnormal.	1. Check if the ventilation at the inverter installation location is adequate and if the ambient temperature exceeds the maximum allowable range. 2. If ventilation is poor or ambient temperature is too high, improve its ventilation and heat dissipation conditions. 3. If both ventilation and ambient temperature are normal, please contact the dealer or after-sales service center.

Fault Code	Fault Name	Fault Cause	Troubleshooting Recommendation
F66	INV Module Overtemperature	Inverter module temperature is too high. Possible causes: 1. Inverter installation location lacks ventilation. 2. Ambient temperature is too high. 3. Internal fan operation is abnormal.	1. Check if the ventilation at the inverter installation location is adequate and if the ambient temperature exceeds the maximum allowable range. 2. If ventilation is poor or ambient temperature is too high, improve its ventilation and heat dissipation conditions. 3. If both ventilation and ambient temperature are normal, please contact the dealer or after-sales service center.
F67	Boost Module Overtemperature	Boost module temperature is too high. Possible causes: 1. Inverter installation location lacks ventilation. 2. Ambient temperature is too high. 3. Internal fan operation is abnormal.	1. Check if the ventilation at the inverter installation location is adequate and if the ambient temperature exceeds the maximum allowable range. 2. If ventilation is poor or ambient temperature is too high, improve its ventilation and heat dissipation conditions. 3. If both ventilation and ambient temperature are normal, please contact the dealer or after-sales service center.

Fault Code	Fault Name	Fault Cause	Troubleshooting Recommendation
F68	AC Capacitor Overtemperature	Output filter capacitor temperature is too high. Possible causes: 1. Inverter installation location lacks ventilation. 2. Ambient temperature is too high. 3. Internal fan operation is abnormal.	1. Check if the ventilation at the inverter installation location is adequate and if the ambient temperature exceeds the maximum allowable range. 2. If ventilation is poor or ambient temperature is too high, improve its ventilation and heat dissipation conditions. 3. If both ventilation and ambient temperature are normal, please contact the dealer or after-sales service center.
F69	PV IGBT Short Circuit Fault	Possible causes: 1. IGBT short circuit. 2. Inverter sampling circuit abnormality.	Disconnect the AC output side switch and DC input side switch, wait 5 minutes, then close the AC output side switch and DC input side switch. If the fault persists, please contact the dealer or after-sales service center.
F70	PV IGBT Open Circuit Fault	1. Software issue causing no PWM generation. 2. Drive circuit abnormality. 3. IGBT open circuit.	
F71	NTC Abnormality	NTC temperature sensor abnormality.	Disconnect the AC output side switch and DC input side switch, wait 5 minutes, then close the AC output side switch and DC input side switch. If the fault persists, please contact the dealer or after-sales service center.

Fault Code	Fault Name	Fault Cause	Troubleshooting Recommendation
F72	PWM Abnormal	Abnormal PWM waveform detected.	Disconnect the AC output side switch and DC input side switch, wait 5 minutes, then close the AC output side switch and DC input side switch. If the fault persists, please contact the dealer or after-sales service center.
F73	CPU Interrupt Abnormality	CPU interrupt abnormality occurred.	Disconnect the AC output side switch and DC input side switch, wait 5 minutes, then close the AC output side switch and DC input side switch. If the fault persists, please contact the dealer or after-sales service center.
F74	Microelectronics Fault	Functional safety detection detected an abnormality.	Disconnect the AC output side switch and DC input side switch, wait 5 minutes, then close the AC output side switch and DC input side switch. If the fault persists, please contact the dealer or after-sales service center.
F75	PV HCT Fault	Boost current sensor abnormality.	Disconnect the AC output side switch and DC input side switch, wait 5 minutes, then close the AC output side switch and DC input side switch. If the fault persists, please contact the dealer or after-sales service center.
F76	1.5V Reference Abnormality	Reference circuit fault.	Disconnect the AC output side switch and DC input side switch, wait 5 minutes, then close the AC output side switch and DC input side switch. If the fault persists, please contact the dealer or after-sales service center.
F77	0.3V Reference Abnormality	Reference circuit fault.	

Fault Code	Fault Name	Fault Cause	Troubleshooting Recommendation
F78	CPLD Version Recognition Error	CPLD version recognition error.	Disconnect the AC output side switch and DC input side switch, wait 5 minutes, then close the AC output side switch and DC input side switch. If the fault persists, please contact the dealer or after-sales service center.
F79	CPLD Communication Fault	CPLD and DSP communication content error or timeout.	Disconnect the AC output side switch and DC input side switch, wait 5 minutes, then close the AC output side switch and DC input side switch. If the fault persists, please contact the dealer or after-sales service center.
F80	Model Identification Fault	Fault related to model identification error.	Disconnect the AC output side switch and DC input side switch, wait 5 minutes, then close the AC output side switch and DC input side switch. If the fault persists, please contact the dealer or after-sales service center.

9.5.2.2.3 Troubleshooting (Fault Codes F81-F121)

Fault Code	Fault Name	Fault Cause	Troubleshooting Recommendation
F81	P-Bus Overvoltage		Disconnect the AC output side switch and the DC input side switch, wait for 5 minutes, then close the AC output side switch and the DC input side switch. If the fault persists, please contact the dealer or after-sales service center.

Fault Code	Fault Name	Fault Cause	Troubleshooting Recommendation
F82	N-Bus Overvoltage	BUS overvoltage, possible causes: 1. PV voltage is too high; 2. Inverter BUS voltage sampling is abnormal; 3. Poor isolation effect of the split-phase transformer at the inverter output, causing mutual interference when two inverters are grid-connected, with one inverter reporting DC overvoltage during grid connection;	
F83	Bus Overvoltage (Sub CPU1)		Disconnect the AC output side switch and the DC input side switch, wait for 5 minutes, then close the AC output side switch and the DC input side switch. If the fault persists, please contact the dealer or after-sales service center.
F84	P-Bus Overvoltage (Sub CPU1)		

Fault Code	Fault Name	Fault Cause	Troubleshooting Recommendation
F85	N-Bus Overvoltage (Sub CPU1)	BUS overvoltage, possible causes: 1. PV voltage is too high; 2. Inverter BUS voltage sampling is abnormal; 3. Poor isolation effect of the split-phase transformer at the inverter output, causing mutual interference when two inverters are grid-connected, with one inverter reporting DC overvoltage during grid connection;	
F86	Bus Overvoltage (Sub CPU2)		Disconnect the AC output side switch and the DC input side switch, wait for 5 minutes, then close the AC output side switch and the DC input side switch. If the fault persists, please contact the dealer or after-sales service center.
F87	P-Bus Overvoltage (Sub CPU2)		

Fault Code	Fault Name	Fault Cause	Troubleshooting Recommendation
F88	N-Bus Overvoltage (Sub CPU2)	BUS overvoltage, possible causes: 1. PV voltage is too high; 2. Inverter BUS voltage sampling is abnormal; 3. Poor isolation effect of the split-phase transformer at the inverter output, causing mutual interference when two inverters are grid-connected, with one inverter reporting DC overvoltage during grid connection;	
F89	P-Bus Overvoltage (CPLD)		Disconnect the AC output side switch and the DC input side switch, wait for 5 minutes, then close the AC output side switch and the DC input side switch. If the fault persists, please contact the dealer or after-sales service center.

Fault Code	Fault Name	Fault Cause	Troubleshooting Recommendation
F90	N-Bus Overvoltage(CPLD)	BUS overvoltage, possible causes: 1. PV voltage is too high; 2. Inverter BUS voltage sampling is abnormal; 3. Poor isolation effect of the split-phase transformer at the inverter output, causing mutual interference when two inverters are grid-connected, with one inverter reporting DC overvoltage during grid connection;	
F91	FlyCap Software Overvoltage	FlyCap overvoltage, possible causes: 1. PV voltage is too high; 2. Inverter FlyCap voltage sampling is abnormal;	Disconnect the AC output side switch and the DC input side switch, wait for 5 minutes, then close the AC output side switch and the DC input side switch. If the fault persists, please contact the dealer or after-sales service center.
F92	FlyCap Hardware Overvoltage		

Fault Code	Fault Name	Fault Cause	Troubleshooting Recommendation
F93	FlyCap Undervoltage	FlyCap undervoltage, possible causes: 1. PV energy is insufficient; 2. Inverter FlyCap voltage sampling is abnormal;	Disconnect the AC output side switch and the DC input side switch, wait for 5 minutes, then close the AC output side switch and the DC input side switch. If the fault persists, please contact the dealer or after-sales service center
F94	FlyCap Precharge Failure	FlyCap precharge failure, possible causes: 1. PV energy is insufficient; 2. Inverter FlyCap voltage sampling is abnormal;	Disconnect the AC output side switch and the DC input side switch, wait for 5 minutes, then close the AC output side switch and the DC input side switch. If the fault persists, please contact the dealer or after-sales service center
F95	FlyCap Precharge Abnormal	1. Control loop parameters are unreasonable 2. Hardware damage	Disconnect the AC output side switch and the DC input side switch, wait for 5 minutes, then close the AC output side switch and the DC input side switch. If the fault persists, please contact the dealer or after-sales service center

Fault Code	Fault Name	Fault Cause	Troubleshooting Recommendation
F96, F97	String Overcurrent(String1-n) n: Determined based on the actual number of inverter strings	Possible causes: 1. String overcurrent; 2. String current sensor is abnormal	Disconnect the AC output side switch and the DC input side switch, wait for 5 minutes, then close the AC output side switch and the DC input side switch. If the fault persists, please contact the dealer or after-sales service center
F99, F100	String Missing(String1-n) n: Determined based on the actual number of inverter strings	String fuse is open (if present)	Check if the fuse is open.
F101	Battery 1 Precharge fault	Battery 1 precharge circuit fault (precharge resistor burned out, etc.)	Check if the precharge circuit is in good condition, and whether the battery voltage matches the bus voltage after the battery is powered on. If not, please contact the dealer or after-sales service center.
F102	Battery 1 Relay Failure	Battery 1 relay cannot operate normally	After the battery is powered on, check if the battery relay is working, and if a closing sound is heard. If it does not operate, please contact the dealer or after-sales service center.

Fault Code	Fault Name	Fault Cause	Troubleshooting Recommendation
F103	Battery 1 Connection Overvoltage	Battery 1 connection voltage exceeds the machine's rated range	Confirm if the battery voltage is within the machine's rated range.
F104	Battery 2 Precharge fault	Battery 2 precharge circuit fault (precharge resistor burned out, etc.)	Check if the precharge circuit is in good condition, and whether the battery voltage matches the bus voltage after the battery is powered on. If not, please contact the dealer or after-sales service center.
F105	Battery 2 Relay Failure	Battery 2 relay cannot operate normally	After the battery is powered on, check if the battery relay is working, and if a closing sound is heard. If it does not operate, please contact the dealer or after-sales service center.
F106	Battery 2 Connection Overvoltage	Battery 2 connection voltage exceeds the machine's rated range	Confirm if the battery voltage is within the machine's rated range.
F107	On-grid PWM Sync Failure	Abnormalities occurred during carrier synchronization grid connection	<ol style="list-style-type: none"> 1. Check if the synchronization cable connection is normal 2. Check if the master/slave settings are normal; 3. Disconnect the AC output side switch and the DC input side switch, wait for 5 minutes, then close the AC output side switch and the DC input side switch. If the fault persists, please contact the dealer or after-sales service center.
F108	DSP Communication fault	-	-

Fault Code	Fault Name	Fault Cause	Troubleshooting Recommendation
F109	External STS fault	Abnormal cable connection between the inverter and the STS	Check if the wiring sequence of the harness between the inverter and the STS corresponds correctly one by one.
F110	Export Limit Protection	<ol style="list-style-type: none"> 1. Inverter reports error and disconnects from grid 2. meter communication is unstable 3. Reverse power flow condition occurs 	<ol style="list-style-type: none"> 1. Check if the inverter has other error messages. If yes, perform targeted troubleshooting; 2. Check if the meter connection is reliable; 3.If this alarm occurs frequently, affecting normal power generation of the power station, please contact the dealer or after-sales service center.
F111	Bypass Overload	-	-
F112	Black Start Failure	-	-
F113	Offgrid AC Ins Volt High	-	-
F114	Relay Failure2	<p>Relay abnormality, causes:</p> <ol style="list-style-type: none"> 1. Relay abnormality (relay short circuit) 2. Relay sampling circuit is abnormal. 3. AC side wiring is abnormal (there may be poor connection or short circuit) 	Disconnect the AC output side switch and the DC input side switch, wait for 5 minutes, then close the AC output side switch and the DC input side switch. If the fault persists, please contact the dealer or after-sales service center.

Fault Code	Fault Name	Fault Cause	Troubleshooting Recommendation
F115	SVG Precharge Disabled	SVG precharge hardware failure	Contact the dealer or after-sales service center.
F116	Nighttime SVG PID Prevention fault	PID prevention hardware abnormality	
F117	DSP Version Recognition Error	DSP software version recognition error	Disconnect the AC output side switch and the DC input side switch, wait for 5 minutes, then close the AC output side switch and the DC input side switch. If the fault persists, please contact the dealer or after-sales service center.
F118	MOS Continuous Overvoltage	<ol style="list-style-type: none"> 1. Software issue causing inverter drive to turn off earlier than flyback drive; 2. Inverter drive circuit abnormal causing failure to turn on; 3. PV voltage is too high; 4. Mos voltage sampling is abnormal; 	Disconnect the AC output side switch and the DC input side switch, wait for 5 minutes, then close the AC output side switch and the DC input side switch. If the fault persists, please contact the dealer or after-sales service center.
F119	Bus Short Circuit fault	Hardware damage	If the inverter remains offline after a BUS short circuit fault occurs, please contact the dealer or after-sales service center.

Fault Code	Fault Name	Fault Cause	Troubleshooting Recommendation
F120	Bus Sampling Abnormality	1. BUS voltage sampling hardware fault	Disconnect the AC output side switch and the DC input side switch, wait for 5 minutes, then close the AC output side switch and the DC input side switch. If the fault persists, please contact the dealer or after-sales service center.
F121	DC Side Sampling Abnormality	1. BUS voltage sampling hardware fault 2. Battery voltage sampling hardware fault 3. Dcrlly relay fault	Disconnect the AC output side switch and the DC input side switch, wait for 5 minutes, then close the AC output side switch and the DC input side switch. If the fault persists, please contact the dealer or after-sales service center.

Fault Code	Fault Name	Fault Cause	Troubleshooting Recommendation
F122	PV Access Mode Setting Error	<p>There are three PV access modes, taking four MPPT channels as an example:</p> <ol style="list-style-type: none"> 1. Parallel mode: i.e., AAAA mode (same source mode), PV1-PV4 are from the same source, all 4 PV channels are connected to the same solar panel 2. Partial parallel mode: i.e., AACC mode, PV1 and PV2 are connected from the same source, PV3 and PV4 are connected from the same source 3. Independent mode: i.e., ABCD mode (different sources), PV1, PV2, PV3, PV4 are connected independently, each of the 4 PV channels is connected to one solar panel <p>If the actual PV</p>	<p>Check if the PV access mode is set correctly (ABCD, AACC, AAAA), reset the PV access mode correctly.</p> <ol style="list-style-type: none"> 1. Confirm that the actual connected PV channels are correctly wired; 2. If the PV is correctly connected, check the currently set "PV Access Mode" via the APP or screen to see if it corresponds to the actual access mode; 3. If the currently set "PV Access Mode" does not match the actual access mode, use the APP or screen to set the "PV Access Mode" to the mode consistent with the actual situation. After setting, disconnect the PV and AC power supply and restart; 4. After setting, if the current "PV Access Mode" matches the actual access mode, but this fault still occurs, please contact the dealer or after-sales service center.

Fault Code	Fault Name	Fault Cause	Troubleshooting Recommendation
		access mode does not match the PV access mode set on the device, this fault will be reported	

9.5.2.2.4 Troubleshooting (Fault Codes F122-F163)

Fault Code	Fault Name	Fault Cause	Troubleshooting Suggestion
F123	Multi-channel PV Phase Error	PV Input Mode Setting Error	<p>Check if the PV Access Mode is set correctly (ABCD, AACC, AAAA). Reset the PV Access Mode correctly.</p> <ol style="list-style-type: none"> 1. Confirm that each actual PV channel is correctly connected. 2. If the PV is correctly connected, check via APP or screen whether the currently set "PV Access Mode" corresponds to the actual connection mode. 3. If the currently set "PV Access Mode" does not match the actual connection mode, use the APP or screen to set the "PV Access Mode" to the mode consistent with the actual situation. After setting, disconnect and restart the PV and AC power supply. 4. After setting, if the current "PV Access Mode" matches the actual connection mode but this fault still occurs, please contact the dealer or after-sales service center.
F124	Battery 1 Reverse Connection fault	Battery 1 Positive and Negative Poles Reversed	Check if the polarities of the Battery and the machine terminals are consistent.
F125	Battery 2 Reverse Connection fault	Battery 2 Positive and Negative Poles Reversed	Check if the polarities of the Battery and the machine terminals are consistent.

Fault Code	Fault Name	Fault Cause	Troubleshooting Suggestion
F126	Abnormal Battery Connection	Abnormal Battery Connection	Check if the Battery is working normally.
F127	BAT Overtemperature	Battery temperature is too high. Possible causes: 1. Poor ventilation at the inverter installation location. 2. Ambient temperature is too high. 3. Internal fan operation is abnormal.	Disconnect the AC output side switch and DC input side switch. After 5 minutes, close the AC output side switch and DC input side switch. If the fault persists, please contact the dealer or after-sales service center.
F128	Ref Voltage Abnormal	Reference circuit fault	Disconnect the AC output side switch and DC input side switch. After 5 minutes, close the AC output side switch and DC input side switch. If the fault persists, please contact the dealer or after-sales service center.
F129	Cabinet Under Temperature	Cabinet temperature is too low. Possible cause: Ambient temperature is too low.	Disconnect the AC output side switch and DC input side switch. After 5 minutes, close the AC output side switch and DC input side switch. If the fault persists, please contact the dealer or after-sales service center.
F130	AC Side SPD fault	AC Side Surge Protective Device Failure	Replace the AC side surge protective device.
F131	DC Side SPD fault	DC Side Surge Protective Device Failure	Replace the DC side surge protective device.

Fault Code	Fault Name	Fault Cause	Troubleshooting Suggestion
F132	Internal Fan Abnormal	Internal fan abnormal. Possible causes: 1. Abnormal fan power supply. 2. Mechanical fault (stall). 3. Fan aging or damage.	Disconnect the AC output side switch and DC input side switch. After 5 minutes, close the AC output side switch and DC input side switch. If the fault persists, please contact the dealer or after-sales service center.
F133	External Fan Abnormal	External fan abnormal. Possible causes: 1. Abnormal fan power supply. 2. Mechanical fault (stall). 3. Fan aging or damage.	Disconnect the AC output side switch and DC input side switch. After 5 minutes, close the AC output side switch and DC input side switch. If the fault persists, please contact the dealer or after-sales service center.
F134	PID Diagnosis Abnormal	PID hardware fault or PID paused due to high PV voltage.	No action required for PID pause warning caused by high PV voltage. For PID hardware fault, clear the PID fault by turning the PID switch off and then on, and replace the PID device.

Fault Code	Fault Name	Fault Cause	Troubleshooting Suggestion
F135	Trip-Switch Trip Warning	Possible causes: Overcurrent or PV reverse connection caused the trip-switch to trip.	Contact the dealer or after-sales service center. The tripping reason was due to PV short circuit or reverse connection. Check if there is a history of PV short circuit warning or PV reverse connection warning. If present, maintenance personnel need to check the corresponding PV condition. After checking and confirming no fault, you can manually close the trip-switch and clear this warning via the APP interface's clear historical fault operation.
F136	Historical PV IGBT Short Circuit Warning	Possible causes: Overcurrent caused the trip-switch to trip.	Contact the dealer or after-sales service center. Maintenance personnel need to check the Boost hardware and external string for faults according to the historical PV short circuit warning subcode. After checking and confirming no fault, this warning can be cleared via the APP interface's clear historical fault operation.

Fault Code	Fault Name	Fault Cause	Troubleshooting Suggestion
F137 , F138	Historical PV Reverse Connection Warning (String 1-n) (n: determined by the actual number of inverter strings)	Possible causes: PV reverse connection caused the trip-switch to trip.	Contact the dealer or after-sales service center. Maintenance personnel need to check if the corresponding string has a reverse connection according to the historical PV reverse connection warning subcode, and check if there is a voltage difference in the PV panel configuration. After checking and confirming no fault, this warning can be cleared via the APP interface's clear historical fault operation.
F139	Flash Read/Write Error Warning	Possible causes: 1. Flash content changed. 2. Flash end of life reached.	1. Upgrade to the latest firmware. 2. Contact the dealer or after-sales service center.
F140	Meter Comm Loss	This warning may only occur after enabling anti-backflow function. Possible causes: 1. Meter not connected. 2. Incorrect wiring of the communication cable between the meter and the inverter.	Check the meter wiring and connect the meter correctly. After checking, if the fault persists, please contact the dealer or after-sales service center.
F141	PV Panel Type Identification Failure	PV panel identification hardware abnormal	Contact the dealer or after-sales service center.

Fault Code	Fault Name	Fault Cause	Troubleshooting Suggestion
F142	PV String Mismatch	PV string mismatch. Two strings under the same MPPT have different open-circuit voltage configurations.	Check the open-circuit voltage of the two strings. Configure strings with the same open-circuit voltage under the same MPPT. Prolonged string mismatch poses a safety hazard.
F143	CT Not Connected	CT not connected	Check CT wiring.
F144	CT Reverse Connection	CT reverse connection	Check CT wiring.
F145	PE Loss	Ground wire not connected	Check the ground wire.
F146	String Terminal High Temperature (String 1~8)	Register 37176 PV terminal temperature warning subcode 1 is set.	-
F147	String Terminal High Temperature (String 9~16)	Register 37177 PV terminal temperature warning subcode 2 is set.	-
F148	String Terminal High Temperature (String 17~20)	Register 37178 PV terminal temperature warning subcode 3 is set.	-

Fault Code	Fault Name	Fault Cause	Troubleshooting Suggestion
F149	Historical PV Reverse Connection Warning (String 33~48)	Possible causes: PV reverse connection caused the trip-switch to trip.	Contact the dealer or after-sales service center. Maintenance personnel need to check if the corresponding string has a reverse connection according to the historical PV reverse connection warning subcode, and check if there is a voltage difference in the PV panel configuration. After checking and confirming no fault, this warning can be cleared via the APP interface's clear historical fault operation.
F150	Battery 1 Low Voltage	Battery voltage is below the set value.	-
F151	Battery 2 Low Voltage	Battery voltage is below the set value.	-
F152	Low Voltage of Battery Power	Battery not in charging mode, voltage below shutdown voltage.	-
F153	Battery 1 High Voltage	-	-
F154	Battery 2 High Voltage	-	-

Fault Code	Fault Name	Fault Cause	Troubleshooting Suggestion
F155	Online Low Insulation Resistance	<p>1. Photovoltaic string short circuit to protective earth.</p> <p>2. The photovoltaic string installation environment is humid for a long time and the line has poor insulation to ground.</p>	<p>1. Check the impedance of the photovoltaic string to the protective earth. If a short circuit is found, please rectify the short circuit point.</p> <p>2. Check if the inverter's protective earth wire is correctly connected.</p> <p>3. If it is confirmed that the impedance is indeed below the default value in rainy conditions, please reset the "Insulation Resistance Protection Point".</p>
F156	Micro-grid Overload Warning	backup terminal input current is too high.	Occasional occurrence requires no action. If this warning occurs frequently, please contact the dealer or after-sales service center.
F157	Manual Reset	-	-
F158	Generator Phase Sequence Abnormal	-	-
F159	Multiplexed Port Configuration Abnormal	Multiplexed (generator) port is configured for micro-grid or large load, but a generator is actually connected.	Use the APP to change the multiplexed (generator) port configuration.
F160	EMS Forced Off-grid	EMS issued forced off-grid command, but off-grid function is not enabled.	Enable the off-grid function.

Fault Code	Fault Name	Fault Cause	Troubleshooting Suggestion
F161	Passive Anti-islanding Protection	-	-
F162	Grid Type Fault	Actual grid type (two-phase or split-phase) does not match the set safety standard.	Switch to the corresponding safety standard according to the actual grid type.
F163	Grid Phase Instability	Grid abnormal: The rate of change of grid voltage phase does not comply with local grid standards.	<p>1. If it occurs occasionally, it may be a temporary grid anomaly. The inverter will resume normal operation after detecting a normal grid, requiring no manual intervention.</p> <p>2. If it occurs frequently, please check if the grid frequency is within the allowable range. If not, please contact the local power operator.</p>

9.5.2.2.5 Fault Symptom Handling

Fault Name	Fault Cause	Fault Handling Recommendation
Generator Failure	<ol style="list-style-type: none"> 1. If the generator is not connected, this fault will always be displayed. 2. When the generator is operating, if it does not meet the generator safety regulations, this fault will be triggered. 	<ol style="list-style-type: none"> 1. If the generator is not connected, ignore this fault; 2. When this fault occurs due to a generator failure, it is normal; after the generator recovers, wait for a period of time, and the fault will automatically clear; 3. This fault does not affect the normal operation of off-grid mode 4. If both the generator and grid are connected and meet safety requirements, the grid will be prioritized for grid connection, and the system will operate in grid-connected state.
BMS Status Bit Error	BMS module failure	Disconnect the AC output side switch and DC input side switch, wait for 5 minutes, then close the AC output side switch and DC input side switch. If the fault still exists, please contact the dealer or after-sales service center.
Ambient Overtemperature	<ol style="list-style-type: none"> 1. Poor ventilation of the machine 2. Hot air flow back to the ambient temperature sampling point 	Disconnect the AC output side switch and DC input side switch, wait for 5 minutes, then close the AC output side switch and DC input side switch. If the fault still exists, please contact the dealer or after-sales service center.

Fault Name	Fault Cause	Fault Handling Recommendation
PV Terminal Overtemperature	PV terminal overtemperature, possible causes: 1. Inverter installation location is not ventilated. 2. Ambient temperature is too high. 3. Internal fan operation is abnormal.	1. Check if the ventilation at the inverter installation location is good, and if the ambient temperature exceeds the maximum allowable ambient temperature range. 2. If it is not ventilated or the ambient temperature is too high, please improve its ventilation and heat dissipation conditions. 3. If both ventilation and ambient temperature are normal, please contact the dealer or after-sales service center.
BAT Terminal Overtemperature	BAT terminal overtemperature, possible causes: 1. Inverter installation location is not ventilated. 2. Ambient temperature is too high.	1. Check if the ventilation at the inverter installation location is good, and if the ambient temperature exceeds the maximum allowable ambient temperature range.
AC Terminal Overtemperature Warning	AC terminal overtemperature, possible causes: 1. Inverter installation location is not ventilated. 2. Ambient temperature is too high. 3. Internal fan operation is abnormal.	2. If it is not ventilated or the ambient temperature is too high, please improve its ventilation and heat dissipation conditions. 3. If both ventilation and ambient temperature are normal, please contact the dealer or after-sales service center.

Fault Name	Fault Cause	Fault Handling Recommendation
BAT Terminal Overtemperature Warning	BAT terminal overtemperature, possible causes: 1. Inverter installation location is not ventilated. 2. Ambient temperature is too high.	1. Check if the ventilation at the inverter installation location is good, and if the ambient temperature exceeds the maximum allowable ambient temperature range. 2. If it is not ventilated or the ambient temperature is too high, please improve its ventilation and heat dissipation conditions. 3. If both ventilation and ambient temperature are normal, please contact the dealer or after-sales service center.
Three-phase on-grid fault	Three-phase external wiring error	Re-wire the connections.
External STS Failure	Abnormal connection cable between inverter and STS	Check if the wiring sequence of the harness connection between the inverter and STS corresponds one by one in order.

Fault Name	Fault Cause	Troubleshooting Recommendation
Parallel Comm Timeout Shutdown	In parallel operation, if a slave unit fails to communicate with the master for more than 400 seconds.	Check if the parallel communication harness is securely connected. Check if the slave addresses are duplicated.
Three-phase off-grid phase loss fault	Phase loss in a three-phase system group.	1. Check if all inverters are powered on. 2. Check if each phase of the three-phase group is connected to an inverter.

Fault Name	Fault Cause	Troubleshooting Recommendation
EPO	External hardware EPO button triggered or remote EPO command triggered.	<ol style="list-style-type: none"> 1. If it was triggered by a remote shutdown command, it can be ignored. 2. If not actively triggered, please contact the dealer or after-sales service center.
High combustible gas concentration	Automatically triggered when the combustible gas device detects a concentration of 20% LEL or higher.	<ol style="list-style-type: none"> 1. After the fault occurs, the machine will automatically open the air valve to exhaust and reduce the concentration. The fault will clear automatically after the concentration remains below 5% LEL for 15 minutes. 2. If a cluster-level fire protection fault is triggered after this fault, the air valve will be automatically closed. Confirm the air valve status within 30s to ensure the cluster-level fire protection operates in a sealed space. 3. Please contact the dealer or after-sales service center.
Combustible gas device air valve open command and feedback signal mismatch	The control signal to open the air valve does not match the feedback signal.	<ol style="list-style-type: none"> 1. Check the harness signal connection for issues. 2. Please contact the dealer or after-sales service center.
One-click shutdown	Check via the App if the one-click shutdown function is enabled.	Disable the one-click shutdown.

Fault Name	Fault Cause	Troubleshooting Recommendation
Offline shutdown	-	-
Remote shutdown	-	-
On-Grid SPD Fault	-	<ol style="list-style-type: none"> 1. Try restarting the machine and observe if the fault clears; 2. If the fault persists after restart, please contact the dealer or after-sales service center.
Off-Grid SPD Fault	-	<ol style="list-style-type: none"> 1. Try restarting the machine and observe if the fault clears; 2. If the fault persists after restart, please contact the dealer or after-sales service center.
Child Node Communication Failure	Internal Comm Abnormal	<ol style="list-style-type: none"> 1. Try restarting the machine and observe if the fault clears; 2. If the fault persists after restart, please contact the dealer or after-sales service center.
Dehumidifier communication fault	Communication link abnormality between the dehumidifier and the LC control box.	<ol style="list-style-type: none"> 1. Check the link communication harness and observe if the fault clears. 2. Try restarting the machine and observe if the fault clears. 3. If the fault persists after restart, please contact the dealer or after-sales service center.

Fault Name	Fault Cause	Troubleshooting Recommendation
Combustible gas detection device communication fault	<ol style="list-style-type: none"> 1. The combustible gas device was not properly configured with a 485 address of 2 during factory setup. 2. Communication link abnormality between the combustible gas device and the LC control box. 	<ol style="list-style-type: none"> 1. Check the link communication harness and observe if the fault clears. 2. Try restarting the machine and observe if the fault clears. 3. Use the method provided by the combustible gas device manufacturer to check if the device's address is 2. If not, modify it. 4. If the fault persists after restart, please contact the dealer or after-sales service center.
DG Communication Failure	Communication link abnormality between the control board and the diesel generator.	<ol style="list-style-type: none"> 1. Check the link communication harness and observe if the fault clears. 2. Try restarting the machine and observe if the fault clears. 3. If the fault persists after restart, please contact the dealer or after-sales service center.
Battery Over Voltage	<ol style="list-style-type: none"> 1. Individual cell voltage is too high. 2. Voltage sensing line abnormality. 	Record the fault phenomenon, restart the battery, wait a few minutes, and confirm if the fault disappears. If the problem persists after restart, please contact the after-sales service center.
Battery Undervoltage	<ol style="list-style-type: none"> 1. Battery total voltage is too high. 2. Voltage sensing line abnormality. 	

Fault Name	Fault Cause	Troubleshooting Recommendation
	<ol style="list-style-type: none"> 1. Battery total voltage is too low. 2. Voltage sensing line abnormality. 	
Battery Overcurrent	<ol style="list-style-type: none"> 1. Charging current is too high, battery current limiting abnormality: sudden change in temperature and voltage values. 2. Inverter response abnormality. 	
	Battery discharge current is too high.	
Battery Overtemperature	<ol style="list-style-type: none"> 1. Ambient Overtemperature. 2. Temperature sensor abnormality. 	
Battery Undertemperature	<ol style="list-style-type: none"> 1. Ambient temperature is too low. 2. Temperature sensor abnormality. 	
Battery Terminal Overtemperature	Terminal temperature is too high.	

Fault Name	Fault Cause	Troubleshooting Recommendation
Battery Imbalance	<ol style="list-style-type: none"> 1. Excessive temperature difference. At different stages, the battery will limit its power, i.e., limit charge/discharge current. Therefore, this issue is generally difficult to occur. 2. Cell capacity degradation, leading to excessive internal resistance and large temperature rise during overcurrent, resulting in large temperature difference. 3. Poor welding of cell tabs, causing rapid cell temperature rise during overcurrent. 4. Temperature sampling issue. 5. Loose power line connection. 	

Fault Name	Fault Cause	Troubleshooting Recommendation
	<ol style="list-style-type: none"> 1. Inconsistent cell aging levels. 2. Slave board chip issues can also cause excessive cell voltage difference. 3. Slave board balancing issues can also cause excessive cell voltage difference. 4. Caused by harness issues. 	
Insulation Resistance	Insulation resistance damaged.	Check if the ground wire is properly connected, restart the battery. If the problem persists after restart, please contact the after-sales service center.
Pre-charging Failure	Pre-charging Failure	Indicates that during pre-charging, the voltage across the pre-charge MOS always exceeds the specified threshold. Power off and restart, then observe if the fault persists. Check if the wiring is correct and if the pre-charge MOS is damaged.
Sensing line fault	Battery sensing line poor contact or disconnected.	Check wiring, restart the battery. If the problem persists after restart, please contact the after-sales service center.
	Cell voltage sensing line poor contact or disconnected.	Check wiring, restart the battery. If the problem persists after restart, please contact the after-sales service center.
	Cell temperature sensing line poor contact or disconnected.	

Fault Name	Fault Cause	Troubleshooting Recommendation
	Dual-channel current comparison error is too large, or current sensing line loop abnormality.	
	Dual-channel voltage comparison error is too large or MCU vs AFE voltage comparison error is too large, or voltage sensing line loop abnormality.	
	Temperature sensing line loop abnormality or poor contact/disconnection.	
	Overvoltage level 5 or overtemperature level 5, tripping the three-terminal fuse.	The three-terminal fuse is blown. Please contact the after-sales service center to replace the main control board.
Relay or MOS overtemperature	Relay or MOS overtemperature	This fault indicates the MOS tube temperature exceeds the specified threshold. Power off and let it sit for 2 hours for the temperature to recover.
Shunt overtemperature	Shunt overtemperature	This fault indicates the shunt temperature exceeds the specified threshold. Power off and let it sit for 2 hours for the temperature to recover.

Fault Name	Fault Cause	Troubleshooting Recommendation
BMS1 Other Fault 1 (Residential Storage)	Relay or MOS open circuit.	<ol style="list-style-type: none"> 1. Upgrade software, power off and let it sit for 5 minutes, restart and see if the fault persists. 2. If it persists, replace the battery pack.
	Relay or MOS short circuit.	<ol style="list-style-type: none"> 1. Upgrade software, power off and let it sit for 5 minutes, restart and see if the fault persists. 2. If it persists, replace the battery pack.
	Communication abnormality between master cluster and slave cluster, or cell inconsistency between clusters.	<ol style="list-style-type: none"> 1. Check the slave battery information and software version, and whether the communication cable connection to the master is normal. 2. Upgrade software.
	Battery system loop harness abnormality, causing the interlock signal to not form a loop.	Check if the terminal resistor is installed correctly.
	BMS and PCS communication abnormality.	<ol style="list-style-type: none"> 1. Confirm the communication cable interface definition between the inverter and the connected battery is correct. 2. Please contact the after-sales service center to check background data and observe if the inverter and battery software match correctly.

Fault Name	Fault Cause	Troubleshooting Recommendation
	BMS master and slave control communication harness abnormality.	<ol style="list-style-type: none"> 1. Check wiring, restart the battery. 2. Upgrade the battery. If the problem persists after restart, please contact the after-sales service center.
	Communication loss between main negative chips.	
	Circuit breaker, shunt trip abnormality.	<ol style="list-style-type: none"> 1. Power off and let it sit for 5 minutes, restart and see if the fault persists. 2. Observe the blind-mating connectors at the bottom of the PACK and PCU, check if the communication pins are loose or bent.
	MCU self-test failure.	Upgrade software, restart the battery. If the problem persists after restart, please contact the after-sales service center.
	<ol style="list-style-type: none"> 1. Software version is too low or BMS board is damaged. 2. Large number of inverters in parallel, causing excessive inrush current during battery pre-charging. 	<ol style="list-style-type: none"> 1. Upgrade software, observe if the fault persists. 2. For parallel systems, black-start the battery first, then start the inverters.
	MCU internal fault.	Upgrade software, restart the battery. This usually indicates MCU or external component damage. If the problem persists after restart, please contact the after-sales service center.

Fault Name	Fault Cause	Troubleshooting Recommendation
	Total control current exceeds the specified threshold.	<ol style="list-style-type: none"> 1. Power off and let it sit for 5 minutes, restart and see if the fault persists. 2. Check if the inverter power setting is too high, causing it to exceed the bus load.
	Inconsistent cells in parallel clusters.	Confirm if the cells in the parallel battery clusters are consistent.
	Reverse polarity connection of parallel cluster battery.	Check if the positive and negative terminals of the parallel cluster battery are reversed.
	Severe overtemperature/overvoltage, etc., triggering the fire protection system.	Contact the after-sales service center.
Air Conditioner Failure	Air conditioner abnormal failure.	Try restarting the system. If the fault is not resolved, please contact the after-sales service center.
	Cabinet door not closed.	Check if the cabinet door is properly closed.
	Supply voltage too high.	Confirm if the supply voltage meets the air conditioner input voltage requirements. Confirm compliance, then power on again.
	Supply voltage insufficient.	
	No voltage input.	
	Supply voltage unstable.	
	Compressor voltage unstable.	

Fault Name	Fault Cause	Troubleshooting Recommendation
	Sensor poor contact or damaged.	Try restarting the system. If the fault is not resolved, please contact the after-sales service center.
	Air conditioner fan abnormal.	
BMS1 Other Fault 2 (Residential Storage)	DCDC internal voltage or current abnormality.	Refer to specific DC fault content.
	DCDC overload or heatsink overtemperature, etc.	
	Cell sensing abnormality or inconsistent aging levels.	Please contact the after-sales service center.
	Fan operation not executed normally.	Please contact the after-sales service center.
	Output port screw loose or poor contact.	<ol style="list-style-type: none"> 1. Power off the battery, check wiring and output port screw condition. 2. After confirmation, restart the battery, observe if the fault persists. If it persists, please contact the after-sales service center.
	Battery used for too long or cells severely damaged.	Please contact the after-sales service center to replace the pack.

Fault Name	Fault Cause	Troubleshooting Recommendation
	1. Software version is too low or BMS board is damaged. 2. Large number of inverters in parallel, causing excessive inrush current during battery pre-charging.	1. Upgrade software, observe if the fault persists. 2. For parallel systems, black-start the battery first, then start the inverters.
	Heating film damaged.	Please contact the after-sales service center.
	Heating film three-terminal fuse blown, heating function unavailable.	Please contact the after-sales service center.
	Software model, Cell Type, hardware model mismatch.	Check if the software model, SN, Cell Type, and hardware model are consistent. If not, please contact the after-sales service center.
	Thermal management board communication line break.	1. Power off and let it sit for 5 minutes, restart and see if the fault persists. 2. If the fault does not recover, contact after-sales to replace the pack.
	Pack fan fault signal triggered.	
DCDC fault	Output port voltage too high.	Check the output port voltage. If the output port voltage is normal and the fault does not clear by itself after restarting the battery, please contact the after-sales service center.

Fault Name	Fault Cause	Troubleshooting Recommendation
	DCDC module detects battery voltage exceeds maximum charging voltage.	Stop charging, discharge to SOC below 90% or let it sit for 2 hours. If ineffective and the fault persists after restart, please contact the after-sales service center.
	Heatsink temperature too high.	Let the battery sit for 1 hour for the heatsink temperature to drop. If ineffective and the fault persists after restart, please contact the after-sales service center.
	Battery discharge current too high.	Check if the load exceeds the battery's discharge capability. Turn off the load or stop the PCS for 60 seconds. If ineffective and the fault persists after restart, please contact the after-sales service center.
	Output port power harness positive/negative reversed with parallel cluster battery or PCS.	Turn off the battery manual switch, check if the output port wiring is correct, restart the battery.
	Output power relay cannot close.	Check if the output port wiring is correct and if there is a short circuit. If ineffective and the fault persists after restart, please contact the after-sales service center.
	Power device temperature too high.	Let the battery sit for 1 hour for the internal power device temperature to drop. If ineffective and the fault persists after restart, please contact the after-sales service center.
	Relay welded/stuck.	If the fault persists after restart, please contact the after-sales service center.

Fault Name	Fault Cause	Troubleshooting Recommendation
Battery Rack Circulating Current Failure	<ol style="list-style-type: none"> 1. Cell imbalance. 2. No full charge calibration during first power-on. 	Record the fault phenomenon, restart the battery, wait a few minutes, and confirm if the fault disappears. If the problem persists after restart, please contact the after-sales service center.
BMS1 Other Fault 3 (Utility Storage)	Communication abnormality with Linux module.	<ol style="list-style-type: none"> 1. Check if the communication cable connection is normal. 2. Upgrade software, restart the battery and observe if the fault persists. If it persists, please contact the after-sales service center.
	Cell temperature rise too fast.	Cell abnormality, contact after-sales to replace the pack.
	SOC below 10%.	Charge the battery.
	SN writing does not comply with rules.	Check if the SN digit count is normal. If abnormal, please contact the after-sales service center.
	<ol style="list-style-type: none"> 1. Daisy chain communication abnormality within a battery rack. 2. Inconsistent cell aging levels between battery racks. 	<ol style="list-style-type: none"> 1. Check the pack contact condition within a single battery rack. 2. Confirm the usage of each rack, such as cumulative charge/discharge capacity, cycle count, etc. 3. Please contact the after-sales service center.
	High humidity inside the pack.	-
	Fuse blown.	Contact after-sales to replace the pack.
	Battery low power.	Charge the battery.
BMS1 Other Fault 4 (Utility Storage)	Circuit breaker abnormality.	Contact after-sales to replace the pack.

Fault Name	Fault Cause	Troubleshooting Recommendation
	External device abnormality.	Contact after-sales to replace the pack.
Contact Failure 1	-	-
Contact Failure 2	-	-
Overload Protection (Ksic)	Sustained overload (exceeding 690KVA) for 10s.	Please contact the after-sales service center.
Overload Protection (Smart Port)	Sustained overload (exceeding 690KVA) for 10s.	Please contact the after-sales service center.
Overcurrent Protection (Ksic)	-	-
Overcurrent Protection (Smart Port)	-	-
Master AC On Meter Comm Error	1. Possibly the meter is not connected to the master. 2. Possibly the meter communication cable is loose.	1. Check if the meter is connected to the master. 2. Check if the meter communication cable is loose.
Parallel Slave Meter Error	Meter connected to a slave unit.	Set the machine with the connected meter as the master.





Fault Name	Fault Cause	Troubleshooting Recommendation
Slave AC On Timeout with Master	<ol style="list-style-type: none"> 1. Slave address setting error. 2. Slave communication cable loose. 	<ol style="list-style-type: none"> 1. Check if the slave addresses are duplicated. 2. Check if the parallel communication cable is loose.

9.5.2.3 Battery Fault (LX A5.0-30, LX U5.0-30)







Alarm Status

 When the battery ALM indicator shows red, combine with the SOC indicator display status to locate and troubleshoot the fault.

No.	SOC Indicator	Fault Name	Resolution Steps
1		Battery Over Voltage Battery Undervoltage	<ol style="list-style-type: none"> 1. Check via the APP if the inverter's charging current limit is 0. If it is 0, confirm that the communication cable connection between the battery and the inverter is reliable and communication is normal. 2. Power off and let it sit for 5 minutes. After restarting, confirm if the fault persists. 3. If the fault is not resolved, please contact the after-sales service center.

No.	SOC Indicator	Fault Name	Resolution Steps
2		Battery Overcurrent	<ol style="list-style-type: none"> 1. Check via the APP if the battery model is correct. Confirm if the battery's real-time current is greater than the charging current limit or discharging current limit value. Please contact the after-sales service center. 2. If it is less, power off the battery or upgrade the program. After restarting, confirm if the fault continues to occur. 3. If the fault is not resolved, please contact after-sales.
3		Battery Overtemperature Battery Undertemperature Battery Terminal Overtemperature	Power off and let it sit for 60 minutes, wait for the temperature to recover. After restarting, if the issue still exists, please contact the after-sales service center.
4		Battery Imbalance Low SOH Fault	Power off and let it sit for 30 minutes. After restarting, if the issue still exists, please contact the after-sales service center.
5		Pre-charge Failure Fault	<ol style="list-style-type: none"> 1. Confirm if the battery output terminal and the inverter are connected in reverse. 2. Power off and let it sit for 5 minutes. After restarting, if the issue still exists, please contact the after-sales service center.
6		Collection Line Fault	Confirm if the battery switch is closed. If the battery switch is closed and the problem still exists, please contact the after-sales service center.

No.	SOC Indicator	Fault Name	Resolution Steps
7	●●○○	Relay or MOS Overtemperature Shunt Overtemperature	Power off and let it sit for 30 minutes. After restarting, if the issue still exists, please contact the after-sales service center.
		Other BMS Faults: Output Port Overtemperature Fault	1. Check if the battery power cable is tightened. Power off and let it sit for 5 minutes. After restarting, if the issue still exists, please contact the after-sales service center.
8	○●●○	Other Protections: MOS Cannot Close	Power off and let it sit for 5 minutes. After restarting, if the issue still exists, please contact the after-sales service center.
9	○●●●	Other Protections: MOS Sticking	
10	●○○○	Other Protections: Parallel Cluster Fault	1. Confirm if the type and installation position of the terminal resistor are correct. 2. Confirm that the communication cable connections between batteries and between the battery and inverter are reliable and communication is normal. 3. If the fault is not resolved, please contact the after-sales service center.





No.	SOC Indicator	Fault Name	Resolution Steps
11		Other Protections: Communication Loss with Inverter	<ol style="list-style-type: none"> 1. Confirm that the communication cable connections between batteries and between the battery and inverter are reliable and communication is normal. 2. If the fault is not resolved, please contact the after-sales service center.
12		Other Protections: BMU Communication Fault	<ol style="list-style-type: none"> 1. Confirm if the type and installation position of the terminal resistor are correct. 2. Confirm that the communication cable connections between batteries and between the battery and inverter are reliable and communication is normal. 3. Power off and let it sit for 5 minutes. After restarting, if the issue still exists, please contact the after-sales service center.
13		Other Protections: Circuit Breaker Sticking Fault	Power off and let it sit for 5 minutes. After restarting, if the issue still exists, please contact the after-sales service center.
14		Other Protections: Software Failure	Restart the battery. After restarting, if the issue still exists, please contact the after-sales service center.
15		Other Protections: Hardware Overcurrent Fault	
16		Other Protections: Microelectronic Fault	



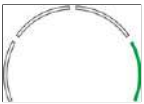

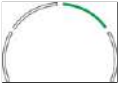
No.	SOC Indicator	Fault Name	Resolution Steps
		Heating Film Three-Terminal Abnormality	<ol style="list-style-type: none"> 1. Upgrade the software. 2. Power off and let it sit for 5 minutes. After restarting, if the issue still exists, please contact the after-sales service center.



9.5.2.4 Battery Fault (GW14.3-BAT-LV-G10)

When the battery alarm indicator shows red , the outer ring marquee lights show red flashing , and the running light is off, locate and troubleshoot the fault based on the status indicated by the SOC indicator.

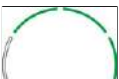

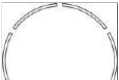
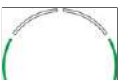
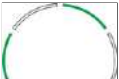
No.	SOC Indicator	Fault Name	Resolution
1		Battery Over Voltage Battery Undervoltage	<ol style="list-style-type: none"> 1. Check via the App whether the inverter's charging current limit is 0. If it is 0, verify that the communication cable connection between the battery and the inverter is reliable and communication is normal. 2. Power off and let it sit idle for 5 minutes. After restarting, confirm if the fault persists. 3. If the fault is not resolved, please contact the after-sales service center.

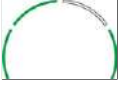
2		Battery Overcurrent	<p>1. Check via the App whether the battery model is correct. Confirm if the battery's real-time current is greater than the charging current limit or discharging current limit. If so, please contact the after-sales service center.</p> <p>2. If it's less, power off the battery or upgrade the software. Restart and confirm if the fault continues to occur.</p> <p>3. If the fault is not resolved, please contact after-sales.</p>
3		Battery Overtemperature	Power off and let it sit idle for 60 minutes, waiting for the temperature to recover. If the problem still exists after restarting, please contact the after-sales service center.
		Battery Undertemperature	
		Battery Terminal Overtemperature	
4		Battery Imbalance	Power off and let it sit idle for 30 minutes. If the problem still exists after restarting, please contact the after-sales service center.
		SOH Too Low Fault	
5		Precharge Failure Fault	<p>1. Confirm whether the battery output terminals are connected reversely to the inverter.</p> <p>2. Power off and let it sit idle for 5 minutes. If the problem still exists after restarting, please contact the after-sales service center.</p>
6		Harness Fault	Confirm whether the battery circuit breaker is closed. If the battery circuit breaker is already closed and the problem persists, please contact the after-sales service center.





7		Relay or MOS Overtemperature	Power off and let it sit idle for 30 minutes. If the problem still exists after restarting, please contact the after-sales service center.
		Output Port Overtemperature	1. Check whether the battery power cables are tightened. 2. Power off and let it sit idle for 5 minutes. If the problem still exists after restarting, please contact the after-sales service center.
8		MOS Cannot Close	Power off and let it sit idle for 5 minutes. If the problem still exists after restarting, please contact the after-sales service center.
9		MOS Sticking	
10		Cluster Parallel Fault	1. Confirm the type and installation position of the terminal resistor used are correct. 2. Confirm that the communication cable connections between batteries, and between the battery and the inverter, are reliable and communication is normal. 3. If the fault is not resolved, please contact the after-sales service center.
11		Software/Hardware Version Mismatch	Restart the battery. If the problem still exists after restarting, please contact the after-sales service center.
12		BMU Communication Fault	
13		Circuit Breaker Sticking Fault	Power off and let it sit idle for 5 minutes. If the problem still exists after restarting, please contact the after-sales service center.

14		Software Failure	Restart the battery. If the problem still exists after restarting, please contact the after-sales service center.
15		Hardware Overcurrent Fault	
16		Microelectronics Fault	
		Heater Three-Terminal Anomaly	1. Upgrade the software. 2. Power off and let it sit idle for 5 minutes. If the problem still exists after restarting, please contact the after-sales service center.

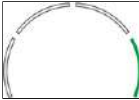
9.5.2.5 Battery Fault (GW16.1-BAT-LV-G10)

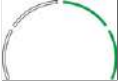
When the battery alarm indicator light shows red , the outer ring marquee light shows red flashing , and the operation light is off, troubleshoot the fault by combining the status indicated by the SOC indicator light.

No.	SOC Indicator Light	Fault Name	Resolution
1		Battery Over Voltage	1. Check via the App if the inverter's charging current limit is 0. If it is 0, confirm whether the communication cable connection between the battery and the inverter is reliable and communication is normal. 2. Power off and let it stand for 5 minutes. After restarting, confirm if the fault persists. 3. If the fault is not resolved, please contact the after-sales service center.
		Battery Undervoltage	

2		Battery Overcurrent	<p>1. Check via the App if the battery model is correct. Confirm if the real-time battery current is greater than the charging current limit or discharge current limit. Please contact the after-sales service center.</p> <p>2. If it is less, power off the battery or upgrade the software. After restarting, confirm if the fault continues to occur.</p> <p>3. If the fault is not resolved, please contact after-sales service.</p>
3		Battery Overtemperature	Power off and let it stand for 60 minutes, waiting for the temperature to recover. If the problem persists after restarting, please contact the after-sales service center.
		Battery Undertemperature	
		Battery Terminal Overtemperature	
4		Battery Imbalance	Power off and let it stand for 30 minutes. If the problem persists after restarting, please contact the after-sales service center.
		SOH Too Low Fault	
5		Precharge Failure Fault	<p>1. Confirm whether the battery output terminals and the inverter are connected reversely.</p> <p>2. Power off and let it stand for 5 minutes. If the problem persists after restarting, please contact the after-sales service center.</p>
6		Harness Fault	Confirm if the battery circuit breaker is closed. If the battery circuit breaker is closed and the problem persists, please contact the after-sales service center.

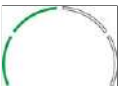
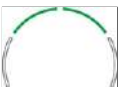
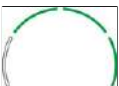
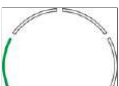
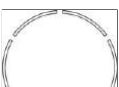
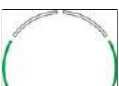
7		Relay or MOS Overtemperature	Power off and let it stand for 30 minutes. If the problem persists after restarting, please contact the after-sales service center.
		Output Port Overtemperature	1. Check if the battery power cables are tightened securely. 2. Power off and let it stand for 5 minutes. If the problem persists after restarting, please contact the after-sales service center.
8		MOS Cannot Close	Power off and let it stand for 5 minutes. If the problem persists after restarting, please contact the after-sales service center.
9		MOS Sticking	
10		Parallel Cluster Fault	1. Confirm whether the type and installation position of the terminal resistor are correct. 2. Confirm whether the communication cable connections between batteries, and between the battery and the inverter, are reliable and communication is normal. 3. Use the battery SN code to confirm whether the cells in the parallel cluster are consistent. 4. If the fault is not resolved, please contact the after-sales service center.
11		Software/Hardware Version Mismatch	Restart the battery. If the problem persists after restarting, please contact the after-sales service center.
12		BMU Communication Fault	

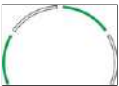
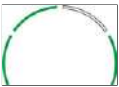
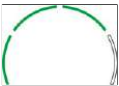
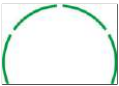
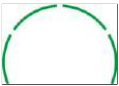
13		Circuit Breaker Sticking Fault	Power off and let it stand for 5 minutes. If the problem persists after restarting, please contact the after-sales service center.
14		Software Failure	Restart the battery. If the problem persists after restarting, please contact the after-sales service center.
15		Hardware Overcurrent Fault	
16		Microelectronics Fault	
16		Heating Film Three-Terminal Abnormality	1. Upgrade the software. 2. Power off and let it stand for 5 minutes. If the problem persists after restarting, please contact the after-sales service center.

9.5.3 Post-Fault Clearance Processing

In energy storage systems, after some faults are handled, post-processing is required for the system to resume normal operation.

9.5.3.1 Clear AFCI Fault Warning

【Software Used】 : SolarGo APP

【Clear Method】 :

1. Go to **[Home] > [Settings] > [Advanced Settings] > [DC Arc Detection]**.
2. Click the **[Clear AFCI Fault Alarm]** button.

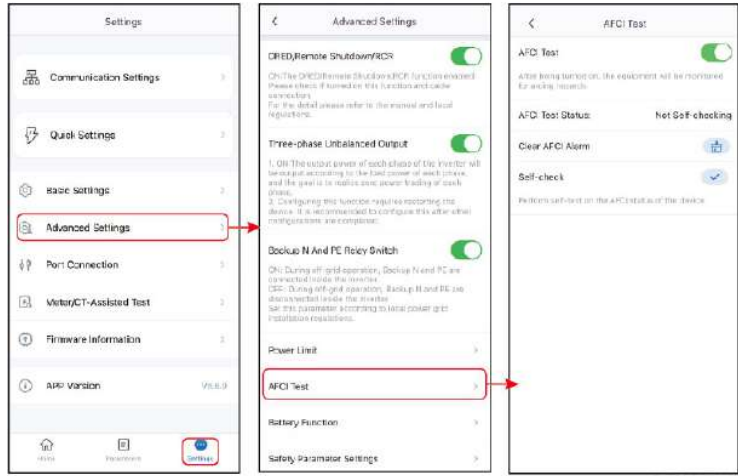

10 technical parameter

10.1 Inverter Parameters

Technical Data	GW5K-ET-L-G10 *8	GW6K-ET-L-G10	GW8K-ET-L-G10
Battery Side			
Battery Type	Li-Ion/Lead-acid	Li-Ion/Lead-acid	Li-Ion/Lead-acid
Nominal Battery Voltage (V)	48	48	48
Battery voltage range (V)	40~60	40~60	40~60
Start-up Voltage(V)	30	30	30
Number of Battery Input	1	1	1
Max. Continuous Charging Current (A)	125	135	175
Max. Continuous Discharging Current (A)	125	135	175
Max Charging Power (kW)	5	6	8
Max Discharging Power (kW)	5.5	6.6	8.8
PV Side			
Max. Input Power (kW)	10	12	16

Technical Data	GW5K-ET-L-G10 *8	GW6K-ET-L-G10	GW8K-ET-L-G10
Max. Input Voltage (V) *1	1000	1000	1000
MPPT Operating Voltage Range (V) *2	150-850	150-850	150-850
MPPT Operating Voltage Range at Nominal Power (V)	300~850	300~850	300~850
Start-up Voltage (V)	180	180	180
Nominal Input Voltage (V)	620	620	620
Max. MPPT Current (A)	20/20	20/20	20/20
Max. MPPT Short Circuit Current (A)	26/26	26/26	26/26
Number of MPPTs	2	2	2
Number of Strings per MPPT	1/1	1/1	1/1
AC Side (On-grid)			
Nominal Power (kW)	5.0	6.0	8.0
Max. Power (kW)	5.5	6.6	8.8
Nominal Power at 40 °C (kW)	5.0	6.0	8.0

Technical Data	GW5K-ET-L-G10 *8	GW6K-ET-L-G10	GW8K-ET-L-G10
Max. Power at 40 °C (kW)	5.0	6.0	8.0
Nominal Apparent Power Output to Grid (kVA)	5.0	6.0	8.0
Max. Apparent Power to Utility Grid (kVA)*9	5.5	6.6	8.8
Nominal Apparent Power from Grid (kVA)	5.0	6.0	8.0
Max. Apparent Power from Grid (kVA)	48.3	48.3	48.3
Nominal Voltage (V)	400/380, 3L/N/PE	400/380, 3L/N/PE	400/380, 3L/N/PE
Voltage Range (V)	170~290	170~290	170~290
Nominal Frequency (Hz)	50/60	50/60	50/60
Frequency Range (Hz)	45~65	45~65	45~65
Max. Current to Grid (A)	7.9@230V 8.3@220V	9.6@230V 10@220V	12.8@230V 13.4@220V
Max. Current From Grid (A)	70	70	70
Nominal Current From Grid (A)	7.5@220V 7.2@230V	9.1@220V 8.7@230V	12.1@220V 11.6@230V

Technical Data	GW5K-ET-L-G10 *8	GW6K-ET-L-G10	GW8K-ET-L-G10
Max. Output Fault Current (Peak and Duration) (A)	99	99	99
Inrush Current (Peak and Duration) (A)	300A/2ms	300A/2ms	300A/2ms
Nominal Current to Grid (A)	7.5@220V 7.2@230V	9.1@220V 8.7@230V	12.1@220V 11.6@230V
Power Factor	~1 (Adjustable from 0.8 leading~0.8 lagging)	~1 (Adjustable from 0.8 leading~0.8 lagging)	~1 (Adjustable from 0.8 leading~0.8 lagging)
THDI	<3%	<3%	<3%
Maximum Output Overcurrent Protection (A)	70	70	70
Type of voltage	a.c.	a.c.	a.c.
Back-up Side			
Nominal Output Apparent Power (kVA)	5.0	6.0	8.0
Max. Output Apparent Power(kVA)	5.5 (10.0, 10s)	6.6 (12.0, 10s)	8.8 (16.0, 10s)
Max. Output Apparent Power with Grid (kVA)	48.3	48.3	48.3

Technical Data	GW5K-ET-L-G10 *8	GW6K-ET-L-G10	GW8K-ET-L-G10
Nominal Output Current (A)	7.5@220V 7.2@230V	9.1@220V 8.7@230V	12.1@220V 11.6@230V
Max Output Current(Bypass)	70	70	70
Max. Fault Current (Peak and Duration) (A)	99 @100ms	99 @100ms	99 @100ms
Inrush Current (Peak and Duration) (A)	300 @2ms	300 @2ms	300 @2ms
Maximum Overcurrent Protection (A)	70	70	70
Nominal Output Voltage (V)	400/380, 3L/N/PE	400/380, 3L/N/PE	400/380, 3L/N/PE
Nominal Output Frequency (Hz)	50/60	50/60	50/60
Generator Side			
Nominal Apparent Power (kVA)	20.0	20.0	20.0
Max. Apparent Power (kVA)	20.0	20.0	20.0
Nominal Voltage (V)	400/380	400/380	400/380
Input Voltage Range (V)	170~290	170~290	170~290
Nominal Frequency (Hz)	50/60	50/60	50/60

Technical Data	GW5K-ET-L-G10 *8	GW6K-ET-L-G10	GW8K-ET-L-G10
Frequency Range (Hz)	45~55/55~65	45~55/55~65	45~55/55~65
Max. Current (A)	30.3	30.3	30.3
Efficiency			
Max. Efficiency	97.8%	97.8%	97.8%
European Efficiency	97.0%	97.0%	97.1%
Max. Battery to AC Efficiency	95.5%	95.5%	95.5%
MPPT Efficiency	99.9%	99.9%	99.9%
Protection			
PV String Current Monitoring	Integrated	Integrated	Integrated
PV Insulation Resistance Detection	Integrated	Integrated	Integrated
Residual Current Monitoring	Integrated	Integrated	Integrated
PV Reverse Polarity Protection	Integrated	Integrated	Integrated
Battery Reverse Polarity Protection	Optional	Optional	Optional
Anti-islanding Protection	Integrated	Integrated	Integrated
AC Overcurrent Protection	Integrated	Integrated	Integrated
AC Short Circuit Protection	Integrated	Integrated	Integrated

Technical Data	GW5K-ET-L-G10 *8	GW6K-ET-L-G10	GW8K-ET-L-G10
AC Overvoltage Protection	Integrated	Integrated	Integrated
DC Switch	Integrated	Integrated	Integrated
AC Switch	NA	NA	NA
DC Surge Protection	Type II	Type II	Type II
AC Surge Protection	Type II	Type II	Type II
AFCI *6	Optional	Optional	Optional
Rapid Shutdown	Optional	Optional	Optional
Remote Shutdown	Integrated	Integrated	Integrated
General Data			
Operating Temperature Range (°C)	-35~+60	-35~+60	-35~+60
Operating Environment	Outdoor	Outdoor	Outdoor
Relative Humidity	0 ~ 95%	0 ~ 95%	0 ~ 95%
Max. Operating Altitude (m)	4000	4000	4000
Cooling Method	Smart Fan Cooling	Smart Fan Cooling	Smart Fan Cooling
User Interface	LCD	LCD	LCD
Communication with BMS	CAN	CAN	CAN
Communication	WIFI+LAN+Bluetooth, 4G, RS485, CAN	WIFI+LAN+Bluetooth, 4G, RS485, CAN	WIFI+LAN+Bluetooth, 4G, RS485, CAN

Technical Data	GW5K-ET-L-G10 *8	GW6K-ET-L-G10	GW8K-ET-L-G10
Communication Protocols	Modbus RTU(RS485), Modbus TCP/IP(Ethernet), Sunspec Modbus RTU	Modbus RTU(RS485), Modbus TCP/IP(Ethernet), Sunspec Modbus RTU	Modbus RTU(RS485), Modbus TCP/IP(Ethernet), Sunspec Modbus RTU
Weight (kg)	42.2	42.2	42.2
Dimension (W×H×D mm)	551*756*258	551*756*258	551*756*258
Noise Emission (dB)	<45	<45	<45
Topology	Non-isolated	Non-isolated	Non-isolated
Power Self-consumption at Night (W)	<15	<15	<15
Ingress Protection Rating	IP66	IP66	IP66
Anti-corrosion Class	C4	C4	C4
DC Connector	MC4	MC4	MC4
AC Connector	Tube Terminal	Tube Terminal	Tube Terminal
Environmental Category	4K4H	4K4H	4K4H
Pollution Degree	III	III	III
Overvoltage Category	DC II / AC III	DC II / AC III	DC II / AC III
Protective Class	I	I	I
Storage Temperature (°C)	-40~70	-40~70	-40~70

Technical Data	GW5K-ET-L-G10 *8	GW6K-ET-L-G10	GW8K-ET-L-G10
Decisive Voltage Classification (DVC)	Battery: A PV: C AC: C Com: A	Battery: A PV: C AC: C Com: A	Battery: A PV: C AC: C Com: A
Mounting Method	Wall Mounted	Wall Mounted	Wall Mounted
Active Anti-islanding Method	AFDPF + AQDPF *7	AFDPF + AQDPF *7	AFDPF + AQDPF *7
Type of Electrical Supply System	Three phase Grid	Three phase Grid	Three phase Grid
Country of Manufacture	China	China	China
Certification			
Grid Standards	NRS 097-2-1, IEC 62116, IEC 61727, IEC 61683, IEC 62891, IEC 60068, EN50530		
Safety Regulation	IEC 62109-1, IEC 62109-2		
EMC	IEC 62920, IEC 61000, EN300328, EN 301489, EN IEC 62311, EN 62479		

Technical Data	GW10K-ET-L-G10	GW12K-ET-L-G10	GW15K-ET-L-G10
Battery Side			
Battery Type	Li-Ion/Lead-acid	Li-Ion/Lead-acid	Li-Ion/Lead-acid
Nominal Battery Voltage (V)	48	48	48
Battery voltage range (V)	40~60	40~60	40~60
Start-up Voltage(V)	30	30	30

Technical Data	GW10K-ET-L-G10	GW12K-ET-L-G10	GW15K-ET-L-G10
Number of Battery Input	1	1	2
Max. Continuous Charging Current (A)	220	250	165/165
Max. Continuous Discharging Current (A)	220	250	165/165
Max Charging Power (kW)	10	12	15
Max Discharging Power (kW)	11	13.2	16.5
PV Side			
Max. Input Power (kW)	20	24	30
Max. Input Voltage (V) *1	1000	1000	1000
MPPT Operating Voltage Range (V) *2	150-850	150-850	150-850
MPPT Operating Voltage Range at Nominal Power (V)	300~850	300~850	350~850
Start-up Voltage (V)	180	180	180
Nominal Input Voltage (V)	620	620	620

Technical Data	GW10K-ET-L-G10	GW12K-ET-L-G10	GW15K-ET-L-G10
Max. MPPT Current (A)	20/20/20	20/20/20	20/20/20/20
Max. MPPT Short Circuit Current(A)	26/26/26	26/26/26	26/26/26/26
Number of MPPTs	3	3	4
Number of Strings per MPPT	1/1/1	1/1/1	1/1/1/1
AC Side (On-grid)			
Nominal Power (kW)	10.0	12.0	15.0
Max. Power (kW)	11.0	13.2*3	16.5*3
Nominal Power at 40 °C (kW)	10.0	12.0	15.0
Max. Power at 40 °C (kW)	10.0	12.0	15.0
Nominal Apparent Power Output to Grid (kVA)	10.0	12.0	15.0
Max. Apparent Power to Utility Grid (kVA) ^{*9}	11.0	13.2	16.5
Nominal Apparent Power from Grid(kVA)	10.0	12.0	15.0
Max. Apparent Power from Grid (kVA)	48.3	48.3	48.3

Technical Data	GW10K-ET-L-G10	GW12K-ET-L-G10	GW15K-ET-L-G10
Nominal Voltage (V)	400/380, 3L/N/PE	400/380, 3L/N/PE	400/380, 3L/N/PE
Voltage Range (V)	170~290	170~290	170~290
Nominal Frequency (Hz)	50/60	50/60	50/60
Frequency Range (Hz)	45~65	45~65	45~65
Max. Current to Grid (A)	15.9@230V 16.7@220V	19.1@230V *4 20@220V	23.9@230V *4 25@220V
Max. Current From Grid (A)	70	70	70
Nominal Current From Grid (A)	15.2@220V 14.5@230V	18.2@220V 17.4@230V	22.7@220V 21.7@230V
Max. Output Fault Current (Peak and Duration) (A)	99	99	99
Inrush Current (Peak and Duration) (A)	300A/2ms	300A/2ms	300A/2ms
Nominal Current to Grid (A)	15.2@220V 14.5@230V	18.2@220V 17.4@230V	22.7@220V 21.7@230V
Power Factor	~1 (Adjustable from 0.8 leading~0.8 lagging)	~1 (Adjustable from 0.8 leading~0.8 lagging)	~1 (Adjustable from 0.8 leading~0.8 lagging)
THDI	<3%	<3%	<3%
Maximum Output Overcurrent Protection (A)	70	70	70

Technical Data	GW10K-ET-L-G10	GW12K-ET-L-G10	GW15K-ET-L-G10
Type of voltage	a.c.	a.c.	a.c.
Backup Side			
Rated Output Apparent Power (kVA)	10.0	12.0	15.0
Maximum Output Apparent Power (kVA)	11.0 (20.0, 10s)	13.2 (24.0, 10s)	16.5 (30.0, 10s)
Maximum Output Apparent Power with Grid (kVA)	48.3	48.3	48.3
Rated Output Current (A)	15.2@220V 14.5@230V	18.2@220V 17.4@230V	22.7@220V 21.7@230V
Maximum Output Current (Bypass)	70	70	70
Maximum Fault Current (Peak and Duration) (A)	99 @100ms	99 @100ms	99 @100ms
Inrush Current (Peak and Duration) (A)	300 @2ms	300 @2ms	300 @2ms
Maximum Overcurrent Protection (A)	70	70	70
Rated Output Voltage (V)	400/380, 3L/N/PE	400/380, 3L/N/PE	400/380, 3L/N/PE

Technical Data	GW10K-ET-L-G10	GW12K-ET-L-G10	GW15K-ET-L-G10
Rated Output Frequency (Hz)	50/60	50/60	50/60
Generator Side			
Rated Apparent Power (kVA)	20.0	20.0	20.0
Maximum Apparent Power (kVA)	20.0	20.0	20.0
Rated Voltage (V)	400/380	400/380	400/380
Input Voltage Range (V)	170~290	170~290	170~290
Nominal Frequency (Hz)	50/60	50/60	50/60
Frequency Range (Hz)	45~55/55~65	45~55/55~65	45~55/55~65
Max. Current (A)	30.3	30.3	30.3
Efficiency			
Max. Efficiency	97.8%	97.8%	97.9%
European Efficiency	97.3%	97.3%	97.3%
Max. Battery to AC Efficiency	95.5%	95.5%	95.5%
MPPT Efficiency	99.9%	99.9%	99.9%
Protection			
PV String Current Monitoring	Integrated	Integrated	Integrated
PV Insulation Resistance Detection	Integrated	Integrated	Integrated

Technical Data	GW10K-ET-L-G10	GW12K-ET-L-G10	GW15K-ET-L-G10
Residual Current Monitoring	Integrated	Integrated	Integrated
PV Reverse Polarity Protection	Integrated	Integrated	Integrated
Battery Reverse Polarity Protection	Optional	Optional *5	Optional *5
Anti-islanding Protection	Integrated	Integrated	Integrated
AC Overcurrent Protection	Integrated	Integrated	Integrated
AC Short Circuit Protection	Integrated	Integrated	Integrated
AC Overvoltage Protection	Integrated	Integrated	Integrated
DC Switch	Integrated	Integrated	Integrated
AC Switch	NA	NA	NA
DC Surge Protection	Type II	Type II	Type II
AC Surge Protection	Type II	Type II	Type II
AFCI *6	Optional	Optional	Optional
Rapid Shutdown	Optional	Optional	Optional
Remote Shutdown	Integrated	Integrated	Integrated
General Data			
Operating Temperature Range (°C)	-35~+60	-35~+60	-35~+60

Technical Data	GW10K-ET-L-G10	GW12K-ET-L-G10	GW15K-ET-L-G10
Operating Environment	Outdoor	Outdoor	Outdoor
Relative Humidity	0 ~ 95%	0 ~ 95%	0 ~ 95%
Max. Operating Altitude (m)	4000	4000	4000
Cooling Method	Smart Fan Cooling	Smart Fan Cooling	Smart Fan Cooling
User Interface	LCD	LCD	LCD
Communication with BMS	CAN	CAN	CAN
Communication	WIFI+LAN+Bluetooth, 4G, RS485, CAN	WIFI+LAN+Bluetooth, 4G, RS485, CAN	WIFI+LAN+Bluetooth, 4G, RS485, CAN
Communication Protocols	Modbus RTU(RS485), Modbus TCP/IP(Ethernet), Sunspec Modbus RTU	Modbus RTU(RS485), Modbus TCP/IP(Ethernet), Sunspec Modbus RTU	Modbus RTU(RS485), Modbus TCP/IP(Ethernet), Sunspec Modbus RTU
Weight (kg)	45.3	45.3	49.7
Dimension (W×H×D mm)	551*756*258	551*756*258	551*756*258
Noise Emission (dB)	<45	<45	<45
Topology	Non-isolated	Non-isolated	Non-isolated
Power Self-consumption at Night (W)	<15	<15	<15
Ingress Protection Rating	IP66	IP66	IP66

Technical Data	GW10K-ET-L-G10	GW12K-ET-L-G10	GW15K-ET-L-G10
Anti-corrosion Class	C4	C4	C4
DC Connector	MC4	MC4	MC4
AC Connector	Tube Terminal	Tube Terminal	Tube Terminal
Environmental Category	4K4H	4K4H	4K4H
Pollution Degree	III	III	III
Overvoltage Category	DC II / AC III	DC II / AC III	DC II / AC III
Protective Class	I	I	I
Storage Temperature (°C)	-40~70	-40~70	-40~70
Decisive Voltage Classification (DVC)	Battery: A PV: C AC: C Com: A	Battery: A PV: C AC: C Com: A	Battery: A PV: C AC: C Com: A
Mounting Method	Wall Mounted	Wall Mounted	Wall Mounted
Active Anti-islanding Method	AFDPF + AQDPF *7	AFDPF + AQDPF *7	AFDPF + AQDPF *7
Type of Electrical Supply System	Three phase Grid	Three phase Grid	Three phase Grid
Country of Manufacture	China	China	China
Certification			
Grid Standards	NRS 097-2-1, IEC 62116, IEC 61727, IEC 61683, IEC 62891, IEC 60068, EN50530		
Safety Regulation	IEC 62109-1, IEC 62109-2		

Technical Data	GW10K-ET-L-G10	GW12K-ET-L-G10	GW15K-ET-L-G10
EMC	IEC 62920, IEC 61000, EN300328, EN 301489, EN IEC 62311, EN 62479		

Technical Data	GW20K-ET-L-G10	GW12K-ET-LL-G10 *8
Battery Side		
Battery Type	Li-Ion/Lead-acid	Li-Ion/Lead-acid
Nominal Battery Voltage (V)	48	48
Battery voltage range (V)	40~60	40~60
Start-up Voltage(V)	30	30
Number of Battery Input	2	1
Max. Continuous Charging Current (A)	208/208	250
Max. Continuous Discharging Current (A)	208/208	250
Max Charging Power (kW)	20	12
Max Discharging Power (kW)	22	13.2
PV Side		
Max. Input Power (kW)	40	24

Technical Data	GW20K-ET-L-G10	GW12K-ET-LL-G10 *8
Max. Input Voltage (V) *1	1000	1000
MPPT Operating Voltage Range (V) *2	150-850	150-850
MPPT Operating Voltage Range at Nominal Power (V)	350~850	300~850
Start-up Voltage (V)	180	180
Nominal Input Voltage (V)	620	620
Max. MPPT Current (A)	20/20/20/20	20/20/20
Max. MPPT Short Circuit Current(A)	26/26/26/26	26/26/26
Number of MPPTs	4	3
Number of Strings per MPPT	1/1/1/1	1/1/1
AC Side (On-grid)		
Nominal Power (kW)	20.0	12.0
Max. Power (kW)	22.0*3	12.0
Nominal Power at 40 °C (kW)	20.0	12.0

Technical Data	GW20K-ET-L-G10	GW12K-ET-LL-G10 *8
Max. Power at 40 °C (kW)	20.0	12.0
Nominal Apparent Power Output to Grid (kVA)	20.0	12.0
Max. Apparent Power to Utility Grid (kVA)*9	22.0	13.2
Nominal Apparent Power from Grid(kVA)	20.0	12.0
Max. Apparent Power from Grid (kVA)	48.3	26.7
Nominal Voltage (V)	400/380, 3L/N/PE	220, 3L/N/PE
Voltage Range (V)	170~290	170~290
Nominal Frequency (Hz)	50/60	60
Frequency Range (Hz)	45~65	55~65
Max. Current to Grid (A)	31.9@230V *4 33.3@220V	31.5@127V
Max. Current From Grid (A)	70	70
Nominal Current From Grid (A)	30.3@220V 29@230V	31.5@127V

Technical Data	GW20K-ET-L-G10	GW12K-ET-LL-G10 *8
Max. Output Fault Current (Peak and Duration) (A)	99	99
Inrush Current (Peak and Duration) (A)	300A/2ms	300A/2ms
Nominal Current to Grid (A)	30.3@220V 29.0@230V	31.5@127V
Power Factor	~1 (Adjustable from 0.8 leading~0.8 lagging)	~1 (Adjustable from 0.8 leading~0.8 lagging)
THDI	<3%	<3%
Maximum Output Overcurrent Protection (A)	70	70
Type of voltage	a.c.	a.c.
Back-up Side		
Nominal Output Apparent Power (kVA)	20.0	12.0
Max. Output Apparent Power(kVA)	22.0 (40.0, 10s)	13.2 (24.0, 10s)
Max. Output Apparent Power with Grid (kVA)	48.3	26.7

Technical Data	GW20K-ET-L-G10	GW12K-ET-LL-G10 *8
Nominal Output Current (A)	30.3@220V 29@230V	31.5@127V
Max Output Current(Bypass)	70	70
Max. Fault Current (Peak and Duration) (A)	99 @100ms	99 @100ms
Inrush Current (Peak and Duration) (A)	300 @2ms	300 @2ms
Maximum Overcurrent Protection (A)	70	70
Nominal Output Voltage (V)	400/380, 3L/N/PE	220, 3L/N/PE
Nominal Output Frequency (Hz)	50/60	60
Generator Side		
Nominal Apparent Power (kVA)	20.0	12.0
Max. Apparent Power (kVA)	20.0	12.0
Nominal Voltage (V)	400/380	220
Input Voltage Range (V)	170~290	170~290
Nominal Frequency (Hz)	50/60	60

Technical Data	GW20K-ET-L-G10	GW12K-ET-LL-G10 *8
Frequency Range (Hz)	45~55/55~65	55~65
Max. Current (A)	30.3	31.5
Efficiency		
Max. Efficiency	97.8%	97.8%
European Efficiency	97.4%	97.3%
Max. Battery to AC Efficiency	95.5%	95.5%
MPPT Efficiency	99.9%	99.9%
Protection		
PV String Current Monitoring	Integrated	Integrated
PV Insulation Resistance Detection	Integrated	Integrated
Residual Current Monitoring	Integrated	Integrated
PV Reverse Polarity Protection	Integrated	Integrated
Battery Reverse Polarity Protection	Optional *5	Integrated
Anti-islanding Protection	Integrated	Integrated
AC Overcurrent Protection	Integrated	Integrated
AC Short Circuit Protection	Integrated	Integrated

Technical Data	GW20K-ET-L-G10	GW12K-ET-LL-G10 *8
AC Overvoltage Protection	Integrated	Integrated
DC Switch	Integrated	Integrated
AC Switch	NA	NA
DC Surge Protection	Type II	Type II
AC Surge Protection	Type II	Type II
AFCI *6	Optional	Integrated
Rapid Shutdown	Optional	Optional
Remote Shutdown	Integrated	Integrated
General Data		
Operating Temperature Range (°C)	-35~+60	-35~+60
Operating Environment	Outdoor	Outdoor
Relative Humidity	0 ~ 95%	0 ~ 95%
Max. Operating Altitude (m)	4000	4000
Cooling Method	Smart Fan Cooling	Smart Fan Cooling
User Interface	LCD	LCD
Communication with BMS	CAN	CAN
Communication	WIFI+LAN+Bluetooth, 4G, RS485, CAN	WIFI+LAN+Bluetooth, 4G, RS485, CAN

Technical Data	GW20K-ET-L-G10	GW12K-ET-LL-G10 *8
Communication Protocols	Modbus RTU(RS485), Modbus TCP/IP(Ethernet), Sunspec Modbus RTU	Modbus RTU(RS485), Modbus TCP/IP(Ethernet), Sunspec Modbus RTU
Weight (kg)	51.2	45.1
Dimension (W×H×D mm)	551*756*258	551*756*258
Noise Emission (dB)	<45	<45
Topology	Non-isolated	Non-isolated
Power Self-consumption at Night (W)	<15	<15
Ingress Protection Rating	IP66	IP66
Anti-corrosion Class	C4	C4
DC Connector	MC4	MC4
AC Connector	Tube Terminal	Tube Terminal
Environmental Category	4K4H	4K4H
Pollution Degree	III	III
Overvoltage Category	DC II / AC III	DC II / AC III
Protective Class	I	I
Storage Temperature (°C)	-40~70	-40~70

Technical Data	GW20K-ET-L-G10	GW12K-ET-LL-G10 *8
Decisive Voltage Classification (DVC)	Battery: A PV: C AC: C Com: A	Battery: A PV: C AC: C Com: A
Mounting Method	Wall Mounted	Wall Mounted
Active Anti-islanding Method	AFDPF + AQDPF *7	AFDPF + AQDPF *7
Type of Electrical Supply System	Three phase Grid	Three phase Grid
Country of Manufacture	China	China
Certification		
Grid Standards	NRS 097-2-1, IEC 62116, IEC 61727, IEC 61683, IEC 62891, IEC 60068, EN50530	
Safety Regulation	IEC 62109-1, IEC 62109-2	
EMC	IEC 62920, IEC 61000, EN300328, EN 301489, EN IEC 62311, EN 62479	

*1: When the input voltage is greater than 980V, the inverter will enter standby mode, and when the voltage returns to below 950V the inverter will return to normal operation.

*2: Please refer to the user manual for the MPPT Voltage Range at Nominal Power.

*3: For Brazil and Chile, the Max. power is the same with the Nominal Power.

*4: For Brazil, for GW12K-ET-L-G10, GW15K-ET-L-G10 and GW20K-ET-L-G10, the Max. Current to Grid is 18.2A@220V, 22.7A@220V and 30.3A@220V respectively.

*5: For Brazil, for GW12K-ET-L-G10, GW15K-ET-L-G10 and GW20K-ET-L-G10, the Battery Reverse Polarity Protection is integrated.

*6: AFCI is integrated in Brazil.

*7: AFDPF: Active Frequency Drift with Positive Feedback, AQDPF: Active Q Drift with Positive Feedback.

*8: GW5K-ET-L-G10 and GW12K-ET-LL-G10 are expected to be available around

October2025.

*9: For Chile, Max. Apparent Power to Utility Grid is same as Nominal Apparent Power Output to Grid.

10.2 Battery Technical Data

10.2.1 LX A5.0-30

Technical Parameters	LX A5.0-30
Nominal Capacity (kWh)	5.12
Usable energy (kWh) * 1	5
Cell Type	LFP (LiFePO4)
Operating Voltage Range (V)	43.2~58.24
Nominal Charge Current (A) *2	60
Max. Continuous Charge Current (A) *2*3	90
Nominal Discharge Current (A) *2	100
Max. Continuous Discharge Current (A) *2*3	150
Max. Pulse Discharge Current (A)*2*3	<200A (30s)
Max. Continuous Discharge Power (W)	7200
Communication	CAN
Operating Temperature Range (°C)	Charge: $0 < T \leq 55$ Discharge: $-20 < T \leq 55$

Technical Parameters	LX A5.0-30
Maximum Operating Altitude (m)	4000
Weight (Kg)	44
Dimensions (W x H x D mm)	442*133*520 (Excluding hanger) 483*133*559 (Including hanger)
Ingress Protection Rating	IP20
Application Method	On-grid/On-grid + Backup/ off Grid
Scalability	Max. 30 in Parallel (150kWh) (Hand to hand /Combiner box /Busbar)
Mounting Method	19-inch standard rack, Floor-mounted, Wall-Mounted
Round-trip Efficiency* ¹	≥96%
Safety	IEC62619、IEC63056、N140
EMC	EN IEC61000-6-1、EN IEC61000-6-2、EN IEC61000-6-3、EN IEC61000-6-4
Transportation	UN38.3、ADR
Environment	ROHS

*1 Test conditions: 100% DOD, 0.2C charge & discharge at 25°C± 2°C, at the beginning of life.

*2 The system's working current and power values will be related to temperature and State of Charge (SOC)

*3 Max charge / discharge current and power values maybe variant with different inverter models.

10.2.2 LX U5.0-30

Technical Parameters	LX U5.0-30
Nominal Battery Energy (kWh)	5.12
Usable Energy (kWh)*1	5
Cell Type	LiFePO4
Nominal Voltage (V)	51.2
Operating Voltage Range (V)	43.2~58.24
Rated Capacity (Ah)	100
Nominal Charge Current (A)	60
Max Charge Current (A)*2*3	90
Nominal Discharge Current (A)*4	100
Max Discharge Current (A)*2*3	100
Pulse Discharging current (A)*2*3	< 200A (30S)
Max. Charging/Discharging Power (kW)	4.95
Communication	CAN
TChg (Charging Temperature Range) (°C)	0<T≤55
TDsch (Discharging Temperature Range) (°C)	-20<T≤55
Ambient Temperature (°C)	0 < T ≤ 40 (Recommend 10 < T ≤ 30)
	Optional heating: -20 < T ≤ 40 (Recommend 10 < T ≤ 30)
Relative Humidity	5~95%
Maximum Storage Time	12 Months (maintenance-free)
Max. Operating Altitude (m)	4000
Heating	Optional
Fire Suppression	Optional, Aerosol
Unit Weight (kg)	50
Unit Dimensions (W*H*D mm)	460*580*160
Enclosure Protection Rating	IP65
Applications	On Grid / On Grid + Backup / off Grid
Scalability	30P

Technical Parameters	LX U5.0-30
Mounting Method	Wall Mounted / Grounded
Round-trip Efficiency*1	≥96%
Cycle Life	> 6000 @25±2°C 0.5C 70%SOH 90%DOD
Safety	VDE2510-50、IEC62619、IEC62040、N140、IEC63056
EMC	EN IEC61000-6-1, EN IEC61000-6-2, EN IEC61000-6-3, EN IEC61000-6-4
Transportation	UN38.3、ADR
Environment	ROHS
<p>*1 Test conditions: 100% DOD, 0.2C charge & discharge at 25°C±2°C, at the beginning of life.</p> <p>*2 The system's working current and power values will be related to temperature and State of Charge (SOC).</p> <p>*3 Max charge / discharge current values may be variant with different inverter models.</p>	

10.2.3 GW14.3-BAT-LV-G10

Technical Data	GW14.3-BAT-LV-G10
Rated Energy (kWh)	14.3
Usable Energy (kWh)*1	≥13.8
Battery Type	LFP (LiFePO ₄)
Nominal Voltage (V)	51.2
Max. Continuous Charging Current (A)	224
Max. Continuous Discharging Current (A)	260
Max. Input Power (System) (kW)*2	12

Technical Data	GW14.3-BAT-LV-G10
Max. Output Power (System) (kW) ^{*2}	12 (13.2 @10min)
Peak Output Power (System) (kW) ^{*2}	20 @15s
Charging Temperature Range (°C)	0~55
Discharging Temperature Range (°C)	-20~55
Relative Humidity	5~85%
Max. Operating Altitude (m)	4000
Noise Emission (dB)	≤35
Communication	CAN, RS485
Weight (kg)	125
Dimensions (W×H×D mm)	530*885*246 (Without the base) 530*918.6*246 (With base included)
Optional Function Configuration	Aerosol
Ingress Protection	IP20
Storage Temperature (°C)	-20~45
Ambient Temperature (°C)	0~45 (Standard configuration) 10~35 (Recommended) -20~45 (Optional)
Max. Storage Time	12 months (-20°C~35°C) 6 months (35°C~45°C)
Scalability	30 pcs
Mounting Method	Floor-Mounted, Wall-Mounted

Technical Data		GW14.3-BAT-LV-G10
Cycle Life		≥6500 (25±2°C, 0.5C, 90%DOD, 70%EOL)
Country of Manufacture		China
Standards and Certification	Safety	IEC 62619, IEC 63056, IEC 60730-1
	EMC	EN IEC61000-6-1, EN IEC61000-6-2, EN IEC61000-6-3, EN IEC61000-6-4
	Transportation	UN38.3, ADR, MSDS

*1: Test conditions, 100% DOD (cell 2.85~3.6V voltage range), 0.2P charge & discharge at 25±2 °C for battery system at the beginning of life. Usable energy is defined by its initial design value. Actual available energy may vary depending on charge/discharge rate, environmental conditions (e.g. temperature), transport and storage factors.

*2: Max. Input Power /Max. Output Power/Peak.Output Power derating will occur related to Temperature and SOC.

10.2.4 GW16.1-BAT-LV-G10

Technical Data		GW16.1-BAT-LV-G10
Battery Type		LFP (LiFePO4)
Rated Capacity (Ah)		314
Rated Energy (kWh)		16.1
Usable Energy (kWh)*1		≥14.9
Nominal Voltage(V)		51.2
Voltage Range(V)		45.92~57.76
Max. Continuous Charging Current (System) (A)		157

Technical Data	GW16.1-BAT-LV-G10
Max. Continuous Discharging Current (System) (A)	200
Max. Input.Power (kW) ^{*2}	8
Max. Output.Power (kW) ^{*2}	10
Peak Output Power (System)(kW) ^{*2}	16 (15s)
Charging Temperature Range(°C)	0~55
Discharging Temperature Range (°C)	-20~55
Relative Humidity	5-95%
Max. Operating Altitude (m)	4000
Communication	CAN
Weight (kg)	≤122
Useable Extinguishing Agent	CO2, H2O
Crucial Material	LiFePO ₄ , C, Cu, LiPF ₆ , Al, (C ₃ H ₆)n
Ingress Protection	IP65
Protective Class	I
Dimensions (W×H×D mm)	≤470*895*245 (No base)
Optional Function Configuration	Regulating wheel (Optional); Aerosol fire extinguishing (Optional)
Storage Temperature (°C)	-20 ~45
Max. Storage time	-20-35°C≤12months
	35-45°C≤ 6 months
Scalability	30P

Technical Data		GW16.1-BAT-LV-G10
Mounting Method		Wall-Mounted、Floor-Mounted
Cycle Life		≥6000 (25±2°C 0.5C 90%DOD 70% SOH)
Country of Manufacture		China
Standard and Certification	Safety	IEC62619, IEC60730, IEC63056, CE
	EMC	CE
	Transportation	UN38.3, MSDS

*1: Test conditions, 100% DOD (cell voltage range 2.87~3.61V), 0.2P charge & discharge at 25±2°C for battery system at beginning of life. Usable energy is defined by its initial design value. Actual available energy may vary depending on charge/discharge rate, environmental conditions (e.g., temperature), and transport and storage factors.

*2: Max. Input Power / Max. Output Power / Peak Output Power derating will occur related to Temperature and SOC.

*3: This refers to the Cycle Life of the battery cell.

10.3 Smart Meter Technical Data

10.3.1 GM330

technical parameter		GM330
Measurement Range	Supported Grid Types	Three-phase, split-phase, single-phase
	Voltage Range L-L (Vac)	172~817
	Voltage Range L-N (Vac)	100~472
	Nominal Frequency (Hz)	50/60
	CT ratio	nA:5A
Communication Parameters	Communication Method	RS485

technical parameter		GM330
	Communication Distance (m/ft)	1000/3280
Accuracy Parameters	Voltage/Current	Class 0.5
	Active Energy	Class 0.5
	Reactive Energy	Class 1
General Parameters	Dimensions (WxHxD mm/in)	72x85x72/2.83x3.35x2.83
	Housing	4 modules
	Weight (g/lb)	240/0.53
	Mounting Method	DIN rail
	User Interface	4 LEDs, Reset Button
	Power Consumption (W)	≤5
Environmental Parameters	IP Rating	IP20
	Operating Temperature Range (°C/°F)	-30~+70/-22~+158
	Storage Temperature Range(°C/°F)	-30~70/-22~+158
	Relative Humidity (no condensation)	0~95%
	Max. Operating Altitude (m/ft)	3000/9842
Certification Parameters	Certificates	UL1741/ANSI

10.4 Smart Dongle Technical Data

10.4.1 WiFi/LAN Kit-20

Technical Parameter		WiFi/LAN Kit-20
Output Voltage (V)		5
Power Consumption (W)		≤2
Communication Interface		USB
	Ethernet	10M/100Mbps Auto-negotiation

Technical Parameter		WiFi/LAN Kit-20
Communication Parameters	Wireless	IEEE 802.11 b/g/n @2.4 GHz
	Bluetooth	Bluetooth V4.2 BR/EDR and Bluetooth LE Standard
Mechanical Parameters	Dimensions (W×H×D mm)	48.3*159.5*32.1
	Weight (g)	82
	Ingress Protection Rating	IP65
	Mounting Method	USB Port Plug-in
Operating Temperature Range (°C)		-30~+60
Storage Temperature Range (°C)		-40~+70
Relative Humidity		0-95%
Max. Operating Altitude (m)		4000

10.4.2 4G Kit-CN-G20

Product Model	4G Kit-CN-G20
Device Management	
Max. Supported Inverter Quantity	1
Electrical Parameters	
Input Voltage (V)	5
Power Consumption (W)	≤4
Interface Type	USB
Communication Parameters	
4G/3G/2G	LTE-FDD: B1/B3/B5/B8 LTE-TDD: B34/B39/B40/B41
GNSS Positioning	/
Bluetooth	Bluetooth V5.0
Mechanical Parameters	
Dimensions (W×H×D mm)	48.3*95.5*32.1
Weight (g)	87
indicator	LED* 2
Mounting Method	Plug and Play
SIM Card Size	Micro sim,15mm*12mm
Environmental Parameters	

Product Model	4G Kit-CN-G20
Operating Temperature Range (°C)	-30~+65
Storage Temperature Range (°C)	-40~+70
Relative Humidity	0-100%
IP Rating	IP66
Max. Operating Altitude (m)	4000
Safety Service Life (Years)	5

10.4.3 4G Kit-G20

Product Model	4G Kit-G20
Device Management	
Max. Supported Inverter Count	1
Power Parameters	
Input Voltage (V)	5
Power Consumption (W)	≤5
Interface Method	USB
Communication Parameters	
4G/3G/2G	LTE-FDD: B1/2/3/4/5/7/8/12/13/18/19/20/25/26/28/66 LTE-TDD: B34/38/39/40/41 WCDMA: B1/2/4/5/6/8/19 GSM/EDGE: B2/3/5/8
GNSS Positioning	/
Bluetooth	Bluetooth V5.0
Mechanical Parameters	
Dimensions (W×H×D mm)	48.3*328*32.3 (including external antenna)
Weight (g)	100 (including external antenna)
indicator	LED* 2
Mounting Method	Plug and Play
SIM Card Size	Micro sim, 15mm*12mm
Environmental Parameters	

Product Model	4G Kit-G20
Operating Temperature Range (°C)	-30~+65
Storage Temperature Range (°C)	-40~+70
Relative Humidity	0-100%
IP Rating	IP66
Max. Operating Altitude (m)	4000
Compliant Standards	
Certification	CE-RED (EN18031) 、RCM

11 Appendix

11.1 FAQ

11.1.1 How to conduct auxiliary detection for smart meters/CT?

The meter detection function can check whether the meter CT is connected correctly and the current operating status of the meter and CT.

- Method One:

1. Navigate through **[Home]** > **[Settings]** > **[Meter/CT Auxiliary Detection]** to enter the detection page.
2. Click Start Detection, wait for the detection to complete, and then view the results.

- Method Two:

1. Click  > **[System Setup]** > **[Quick Setting]** > **[Meter/CT Assisted Test]** to enter the detection page.
2. Click Start Detection, wait for the detection to complete, and then view the results.

11.1.2 How to Upgrade the Device Version

Through firmware information, you can view or upgrade:

The inverter's DSP version, ARM version, communication module software version, battery's BMS version, DCDC version, etc.

- **Prompted Upgrade:**

The user opens the App, and a upgrade prompt pops up on the home page. The user can choose whether to upgrade. If upgrade is selected, follow the on-screen instructions to complete the upgrade.

- **Regular Upgrade:**

Go to **[Home]** > **[Settings]** > **[Firmware Information]** to access the firmware information screen.

Tap "Check for Updates". If a new version is available, follow the on-screen

instructions to complete the upgrade.

- **Mandatory Upgrade:**

The App pushes upgrade information. The user must upgrade as prompted; otherwise, the App cannot be used. Follow the on-screen instructions to complete the upgrade.

Inverter Software Version Upgrade

- The inverter supports software upgrade via a U drive.
- Before using a U drive to upgrade the device, please contact the after-sales service center to obtain the software upgrade package and upgrade method.

11.2 Abbreviations

Abbreviation	English Description	Chinese Description
Ubatt	Battery Voltage Range	Battery voltage range
Ubatt,r	Nominal Battery Voltage	Nominal battery voltage
Ibatt,max (C/D)	Max. Charging Current Max. Discharging Current	Max. Charging/Discharging Current
EC,R	Rated Energy	Rated Energy
UDCmax	Max.Input Voltage	Max. Input Voltage
UMPP	MPPT Operating Voltage Range	MPPT Voltage Range
IDC,max	Max. Input Current per MPPT	Max. Input Current per MPPT
ISC PV	Max. Short Circuit Current per MPPT	Max. Short Circuit Current per MPPT
PAC,r	Nominal Output Power	Nominal output power
Sr (to grid)	Nominal Apparent Power Output to Utility Grid	Nominal Apparent Power Output to Utility Grid
Smax (to grid)	Max. Apparent Power Output to Utility Grid	Max. Apparent Power Output to Utility Grid
Sr (from grid)	Nominal Apparent Power from Utility Grid	Nominal Apparent Power Purchased from Grid
Smax (from grid)	Max. Apparent Power from Utility Grid	Max. Apparent Power Purchased from Grid
UAC,r	Nominal Output Voltage	Nominal output voltage

Abbreviation	English Description	Chinese Description
fAC,r	Nominal AC Grid Frequency	Nominal AC Grid Frequency
IAC,max(to grid)	Max. AC Current Output to Utility Grid	Max. AC Current Output to Utility Grid
IAC,max(from grid)	Max. AC Current From Utility Grid	Max. Current from Grid
P.F.	Power Factor	Power Factor
Sr	Back-up Nominal apparent power	Off-grid Nominal Apparent Power
Smax	Max. Output Apparent Power (VA) Max. Output Apparent Power without Grid	Max. Apparent Power to Grid
IAC,max	Max. Output Current	Max. Current to Grid
UAC,r	Nominal Output Voltage	Max. Output Voltage
fAC,r	Nominal Output Frequency	Nominal Output Voltage Frequency
Toperating	Operating Temperature Range	Operating Temperature Range
IDC,max	Max. Input Current	Max. Input Current
UDC	Input Voltage	Input Voltage
UDC,r	DC Power Supply	DC Input
UAC	Power Supply/AC Power Supply	Input Voltage Range/AC Input
UAC,r	Power Supply/Input Voltage Range	Input Voltage Range/AC Input
Toperating	Operating Temperature Range	Operating Temperature Range
Pmax	Max Output Power	Maximum Power
PRF	TX Power	Transmit Power
PD	Power Consumption	Power Consumption
PAC,r	Power Consumption	Power Consumption
F (Hz)	Frequency	Frequency
ISC PV	Max. Input Short Circuit Current	Max. Input Short Circuit Current
Udcmin-Udcmax	Range of input Operating Voltage	Operating Voltage range
UAC,rang(L-N)	Power Supply Input Voltage	Adapter Input Voltage Range

Abbreviation	English Description	Chinese Description
Usys,max	Max System Voltage	Max. System Voltage
Haltitude,max	Max. Operating Altitude	Max. Operating Altitude
PF	Power Factor	Power Factor
THDi	Total Harmonic Distortion of Current	Current Harmonic Distortion
THDv	Total Harmonic Distortion of Voltage	Voltage Harmonic Distortion
C&I	Commercial & Industrial	Commercial & Industrial
SEMS	Smart Energy Management System	Smart Energy Management System
MPPT	Maximum Power Point Tracking	Maximum Power Point Tracking
PID	Potential-Induced Degradation	Potential-Induced Degradation
Voc	Open-Circuit Voltage	open-circuit voltage
Anti PID	Anti-PID	Anti-PID
PID Recovery	PID Recovery	PID Recovery
PLC	Power-line Commucation	Power-line Carrier Communication
Modbus TCP/IP	Modbus Transmission Control / Internet Protocol	Modbus over TCP/IP
Modbus RTU	Modbus Remote Terminal Unit	Modbus over Serial Link
SCR	Short-Circuit Ratio	Short-Circuit Ratio
UPS	Uninterruptable Power Supply	Uninterruptible Power Supply
ECO mode	Economical Mode	Economic Mode
TOU	Time of Use	Time of Use
ESS	Energy Stroage System	energy storage system
PCS	Power Conversion System	Power Conversion System
RSD	Rapid shutdown	Rapid Shutdown
EPO	Emergency Power Off	Emergency Poweroff
SPD	Surge Protection Device	Surge Protection Device
ARC	zero injection/zero export Power Limit / Export Power Limit	Power Limit
DRED	Demand Response Enabling Device	Demand Response Enabling Device

Abbreviation	English Description	Chinese Description
RCR	Ripple Control Receiver	-
AFCI	AFCI	AFCI DC Arc Fault Protection
GFCI	Ground Fault Circuit Interrupter	GFCI
RCMU	Residual Current Monitoring Unit	Residual Current Monitoring Unit
FRT	Fault Ride Through	Fault Ride Through
HVRT	High Voltage Ride Through	High Voltage Ride Through
LVRT	Low Voltage Ride Through	Low Voltage Ride Through
EMS	Energy Management System	Energy Management System
BMS	Battery Management System	Battery Management System
BMU	Battery Measure Unit	Battery Measurement Unit
BCU	Battery Control Unit	Battery Control Unit
SOC	State of Charge	State of Charge
SOH	State of Health	State of Health
SOE	State Of Energy	State of Energy
SOP	State Of Power	State of Power
SOF	State Of Function	State of Function
SOS	State Of Safety	State of Safety
DOD	Depth of discharge	depth of discharge

11.3 Explanation of Terms

- **Explanation of Overvoltage Categories**
 - **Overvoltage Category I:** Equipment connected to circuits where measures are taken to limit transient overvoltages to a relatively low level.
 - **Overvoltage Category II:** Energy-consuming equipment supplied from a fixed electrical installation. This category includes appliances, portable tools, and other household and similar loads. If special requirements for the reliability and suitability of such equipment exist, Overvoltage Category III applies.
 - **Overvoltage Category III:** Equipment in fixed electrical installations where the reliability and suitability of the equipment must meet special requirements. This includes switching devices in fixed installations and industrial equipment permanently connected to fixed electrical installations.
 - **Overvoltage Category IV:** Equipment used at the origin of the electrical installation, such as electricity meters and primary overcurrent protection devices.

- **Explanation of Damp Location Categories**

Environmental Parameters	Level		
	3K3	4K2	4K4H
Temperature Range	0~+40°C	-33~+40°C	-33~+40°C
Humidity Range	5% to 85%	15% to 100%	4% to 100%

- **Explanation of Environment Categories:**

- **Outdoor Inverter:** Ambient air temperature range from -25°C to +60°C, suitable for Pollution Degree 3 environment.
- **Indoor Type II Inverter:** Ambient air temperature range from -25°C to +40°C, suitable for Pollution Degree 3 environment.
- **Indoor Type I Inverter:** Ambient air temperature range from 0°C to +40°C, suitable for Pollution Degree 2 environment.

- **Explanation of Pollution Degree Categories**

- **Pollution Degree 1:** No pollution or only dry, non-conductive pollution.
- **Pollution Degree 2:** Normally only non-conductive pollution occurs. Temporary conductivity caused by condensation must be expected.
- **Pollution Degree 3:** Conductive pollution occurs, or dry non-conductive pollution becomes conductive due to condensation.
- **Pollution Degree 4:** Persistent conductive pollution occurs, e.g., due to conductive dust or rain or snow.

11.4 Battery SN Code Meaning

*****2388*****



The 11th-14th digits

LXD10DSC0002

Positions 11-14 of the product SN code represent the production date code. The production date in the image above is August 8, 2023.

- Positions 11 and 12 are the last two digits of the production year, e.g., 2023 is represented as 23;
- Position 13 is the production month, e.g., August is represented as 8;
Details are as follows:

Month	Jan-Sep	Oct	Nov	Dec
Month Code	1~9	A	B	C

- Position 14 is the production day, e.g., the 8th is represented as 8;
Numbers are used preferentially, e.g., 1~9 represent the 1st to 9th days, A represents the 10th day, and so on. The letters I and O are not used to avoid confusion. Details are as follows:

Production Day	1	2	3	4	5	6	7	8	9
Code	1	2	3	4	5	6	7	8	9

Production Date	10	11	12	13	14	15	16	17	18
Code	A	B	C	D	E	F	G	H	J

Production Date	21	22	23	24	25	26	27	28	29
Code	M	N	P	Q	R	S	T	U	V

11.5 Safety Country

No.	Safety Code	No.	Safety Code
Europe			
1	IT-CEI 0-21	43	CZ-C
2	IT-CEI 0-16	44	CZ-D
3	DE LV with PV	45	RO-A
4	DE LV without PV	46	RO-B
5	DE-MV	47	RO-D
6	ES-A	48	GB-G98
7	ES-B	49	GB-G99-A

No.	Safety Code	No.	Safety Code
8	ES-C	50	GB-G99-B
9	ES-D	51	GB-G99-C
10	ES-island	52	GB-G99-D
11	BE	53	NI-G98
12	FR	54	IE-16/25A
13	FR-island-50Hz	55	IE-72A
14	FR-island-60Hz	56	IE-ESB
15	PL-A	57	IE-EirGrid
16	PL-B	58	PT-D
17	PL-C	59	EE
18	PL-D	60	NO
19	NL-16/20A	61	FI-A
20	NL-A	62	FI-B
21	NL-B	63	FI-C
22	NL-C	64	FI-D
23	NL-D	65	UA-A1
24	SE-A	66	UA-A2
25	SE MV	67	EN 50549-1
26	SK-A	68	EN 50549-2
27	SK-B	69	DK-West-B-MVHV
28	SK-C	70	DK-East-B-MVHV
29	HU	71	DK-West-C-MVHV
30	CH	72	DK-East-C-MVHV
31	CY	73	DK-West-D-MVHV
32	GR	74	DK-East-D-MVHV
33	DK-West-A	75	FR-Reunion
34	DK-East-A	76	BE-LV (>30kVA)
35	DK-West-B	77	BE-HV
36	DK-East-B	78	CH-B
37	AT-A	79	NI-G99-A
38	AT-B	80	NI-G99-B

No.	Safety Code	No.	Safety Code
39	BG	81	NI-G99-C
40	CZ-A-09	82	NI-G99-D
41	CZ-B1-09	83	IE-LV
42	CZ-B2-09	84	IE-MV
Globe			
1	60Hz-Default	5	IEC 61727-50Hz
2	50Hz-Default	6	IEC 61727-60Hz
3	127Vac-60Hz-Default	7	Warehouse
4	127Vac-50Hz-Default		
America			
1	Argtina	30	US-ISO-NE-480Vac
2	US-208Vac	31	US-ISO-NE-208Vac-3P
3	US-240Vac	32	US-ISO-NE-220Vac-3P
4	Mexico-220Vac	33	US-ISO-NE-240Vac-3P
5	Mexico-440Vac	34	PR-208Vac
6	US-480Vac	35	PR-240Vac
7	US-208Vac-3P	36	PR-480 Vac
8	US-220Vac-3P	37	PR-208Vac-3P
9	US-240Vac-3P	38	PR-220Vac-3P
10	US-CA-208Vac	39	PR-240Vac-3P
11	US-CA-240Vac	40	Cayman
12	US-CA-480Vac	41	Brazil-220Vac
13	US-CA-208Vac-3P	42	Brazil-208Vac
14	US-CA-220Vac-3P	43	Brazil-230Vac
15	US-CA-240Vac-3P	44	Brazil-240Vac
16	US-HI-208Vac	45	Brazil-254Vac
17	US-HI-240Vac	46	Brazil-127Vac
18	US-HI-480Vac	47	Brazil-ONS
19	US-HI-208Vac-3P	48	Barbados
20	US-HI-220Vac-3P	49	Chile-BT
21	US-HI-240Vac-3P	50	Chile-MT

No.	Safety Code	No.	Safety Code
22	US-Kauai-208Vac	51	Colombia
23	US-Kauai-240Vac	52	Colombia<0.25MW 1P
24	US-Kauai-480Vac	53	Colombia<0.25MW 3P
25	US-Kauai-208Vac-3P	54	IEEE 1547-208Vac
26	US-Kauai-220Vac-3P	55	IEEE 1547-20Vac
27	US-Kauai-240Vac-3P	56	IEEE 1547-240Vac
28	US-ISO-NE-208Vac	57	IEEE 1547-230/400Vac
29	US-ISO-NE-240Vac		
Oceania			
1	Australia-A	4	Newzealand
2	Australia-B	5	Newzealand:2015
3	Australia-C	6	NZ-GreGrid
Asia			
1	China A	25	JP-420Vac-50Hz
2	China B	26	JP-420Vac-60Hz
3	China's high pressure	27	JP-480Vac-50Hz
4	China's highest pressure	28	JP-480Vac-60Hz
5	China Power Station	29	Sri Lanka
6	China 242 Shandong	30	Singapore
7	China 242 Hebei	31	Israel-OG
8	China PCS	32	Israel-LV
9	Taiwan	33	Israel-MV
10	Hongkong	34	Israel-HV
11	China 242 Northeast	35	Vietnam
12	Thailand-MEA	36	Malaysia-LV
13	Thailand-PEA	37	Malaysia-MV
14	Mauritius	38	DEWA-LV
15	Korea	39	DEWA-MV
16	India	40	Saudi Arabia
17	India-CEA	41	JP-690Vac-50Hz

No.	Safety Code	No.	Safety Code
18	Pakistan	42	JP-690Vac-60Hz
19	Philippines	43	Srilanka
20	Philippines-127Vac	44	IEC 61727-127Vac-50Hz
21	JP-50Hz	45	IEC 61727-127Vac-60Hz
22	JP-60Hz	46	JP-550Vac-50Hz
23	JP-440Vac-50Hz	47	JP-550Vac-60Hz
24	JP-440Vac-60Hz	48	India-Higher
Africa			
1	South Africa-LV	4	Ghana
2	South Africa-B-MV	5	Ghana-HV
3	South Africa-C-MV		

Contact Information

GoodWe Technologies Co., Ltd.
No. 90 Zijin Road, High-tech Zone, Suzhou, China
400-998-1212
www.goodwe.com
service@goodwe.com